

# Product Data and Part Numbers



**Greyhound**  
CHROMATOGRAPHY  
AND ALLIED CHEMICALS

# Contents

Syringes		Injection Port	
<b>Syringes</b>	<b>5</b>	<b>Injection Port</b>	<b>59</b>
<b>Autosampler</b>	<b>6</b>	<b>Inlet Liners</b>	<b>60</b>
Diamond Headspace	6	ConnecTite	60
Product Data	6	Product Data	60
Part Numbers	7	Part Numbers	61
Diamond MS	8	Double Taper	62
Product Data	8	Product Data	62
Part Numbers	9	Part Numbers	63
GC Autosampler	11	FocusLiner®	64
Product Data	11	Product Data	64
Part Numbers	12	Part Numbers	65
HPLC Autosampler	16	PTV/LVI	66
Product Data	16	Product Data	66
Part Numbers	17	Part Numbers	67
MEPS®	18	Straight	68
Product Data	18	Product Data	68
Part Numbers	19	Part Numbers	69
<b>Manual</b>	<b>20</b>	Taper/Gooseneck	70
<b>Diamond</b>	<b>20</b>	Product Data	70
Product Data	20	Part Numbers	71
Part Numbers	21	Taper FocusLiner®	72
Diamond Gas Tight	22	Product Data	72
Product Data	22	Part Numbers	73
Part Numbers	23	<b>Septum</b>	<b>74</b>
Guided Plunger	24	Signet Septa	
Product Data	24	EC Grade	74
Part Numbers	25	Product Data	74
Jumbo	26	Part Numbers	75
Product Data	26	Signet Septa	
Part Numbers	27	GP Grade	76
For Rheodyne		Product Data	76
and Valco Valves	28	Part Numbers	77
Product Data	28	Signet Septa	
Part Numbers	29	HT Grade	78
<b>Autosampler</b>		Product Data	78
<b>and Manual</b>	<b>30</b>	Part Numbers	79
NanoVolume	30	Signet Septa	
Product Data	30	MN Grade	80
Part Numbers	31	Product Data	80
<b>Dispenser</b>		Part Numbers	81
<b>and Pump</b>	<b>32</b>	<b>Kits</b>	<b>82</b>
For Hamilton C		Injection Port Kit	82
and CX	32	Product Data	82
Product Data	32	Part Numbers	83
Part Numbers	33		
For PSD/3 and			
PSD/4 Pumps	34		
Product Data	34		
Part Numbers	35		
For V3 Pumps	36		
Product Data	36		
Part Numbers	37		
For V6 Pumps	38		
Product Data	38		
Part Numbers	39		
<b>eVol®</b>	<b>40</b>		
eVol® XR	40		
Product Data	40		
Part Numbers	41		
eVol® XR Kits	42		
Product Data	42		
Part Numbers	43		
<b>Replacement</b>			
<b>Parts</b>	<b>44</b>		
Replacement			
Needles	44		
Product Data	44		
Part Numbers	45		
Replacement			
Plungers	49		
Product Data	49		
<b>Cross Reference</b>	<b>50</b>		
Hamilton	50		
Part Numbers	50		

**Separations 85**

**GC Columns 86**

**BP1 86**  
 Product Data 86  
 Part Numbers 87

**BP1 PONA 88**  
 Product Data 88  
 Part Numbers 89

**BP10 (1701) 90**  
 Product Data 90  
 Part Numbers 91

**BP20 (WAX) 92**  
 Product Data 92  
 Part Numbers 93

**BP21 (FFAP) 94**  
 Product Data 94  
 Part Numbers 95

**BP5 96**  
 Product Data 96  
 Part Numbers 97

**BP5MS 98**  
 Product Data 98  
 Part Numbers 99

**BP624 100**  
 Product Data 100  
 Part Numbers 101

**BPX1 102**  
 Product Data 102  
 Part Numbers 103

**BPX35 104**  
 Product Data 104  
 Part Numbers 105

**BPX5 106**  
 Product Data 106  
 Part Numbers 107

**BPX50 108**  
 Product Data 108  
 Part Numbers 109

**BPX608 110**  
 Product Data 110  
 Part Numbers 111

**BPX70 112**  
 Product Data 112  
 Part Numbers 113

**BPX90 114**  
 Product Data 114  
 Part Numbers 115

**BPX-BIOD 116**  
 Product Data 116  
 Part Numbers 117

**BPX-DXN 118**  
 Product Data 118  
 Part Numbers 119

**BPX-PCB 120**  
 Product Data 120  
 Part Numbers 121

**BPX-VOLATILES 122**  
 Product Data 122  
 Part Numbers 123

**CYDEX-B™ 124**  
 Product Data 124  
 Part Numbers 125

**HT5 126**  
 Product Data 126  
 Part Numbers 127

**HT8 128**  
 Product Data 128  
 Part Numbers 129

**SolGel-1ms™ 130**  
 Product Data 130  
 Part Numbers 131

**SolGel-WAX™ 132**  
 Product Data 132  
 Part Numbers 133

**HPLC Capillary Columns 134**

**ProteCol® 134**  
 Product Data 134  
 Part Numbers 135

**HPLC Columns Reverse Phase 139**

**ProteCol® C18 139**  
 Product Data 139  
 Part Numbers 140

**ProteCol® C4 149**  
 Product Data 149  
 Part Numbers 150

**ProteCol® C8 152**  
 Product Data 152  
 Part Numbers 153

**ProteCol® Phenyl Hexyl 156**  
 Product Data 156  
 Part Numbers 157

**HPLC Columns Specialty Phase 159**

**ProteCol® Chiral 159**  
 Product Data 159  
 Part Numbers 160

**ProteCol® HILIC 161**  
 Product Data 161  
 Part Numbers 162

**ProteCol® PFP 166**  
 Product Data 166  
 Part Numbers 167

**ProteCol® SCX 169**  
 Product Data 169  
 Part Numbers 170

**ProteCol® Ultra 172**  
 Product Data 172  
 Part Numbers 173

**ProteCol® Cyano 174**  
 Product Data 174  
 Part Numbers 175

**ProteCol® Silica 176**  
 Product Data 176  
 Part Numbers 177

**ProteCol® Amino 179**  
 Product Data 179  
 Part Numbers 180

**HPLC Columns Reverse and Specialty Phase 181**

**Guard Column**

**ProteCol® 181**  
 Product Data 181  
 Part Numbers 182

**SPE 184**

**eVol® MEPS® BINS 184**  
 Product Data 184  
 Part Numbers 185

**MEPS® BINS 186**  
 Product Data 186  
 Part Numbers 187

**Connections 189**

**GC 190**

**GC Ferrules 190**  
 Graphite 190  
 Product Data 190  
 Part Numbers 191

**GC Ferrules Graphite Vespel® 192**

Product Data 192  
 Part Numbers 193

**GC Ferrules SilTite® 194**

Product Data 194  
 Part Numbers 195

**GC Ferrules SilTite® FingerTite 196**

Product Data 196  
 Part Numbers 197

**GC SilTite® μ-Unions 198**

Product Data 198  
 Part Numbers 199

**GC Nuts for SGE Fittings 200**

Product Data 200  
 Part Numbers 201

**GC Unions 202**

Product Data 202  
 Part Numbers 203

**GC 3 Port Splitter SilFlow® 204**

Product Data 204  
 Part Numbers 205

**GC 4 Port Splitter SilFlow® 206**

Product Data 206  
 Part Numbers 207

**GC Deans' Switch SilFlow® 208**

Product Data 208  
 Part Numbers 209

**HPLC 210**

**HPLC EasyLok™ 210**

Product Data 210  
 Part Numbers 211

**HPLC Fittings PEEK Fingertight 212**

Product Data 212  
 Part Numbers 213

**HPLC Hexnut™ 214**

Product Data 214  
 Part Numbers 215

**HPLC Unions 216**

Product Data 216  
 Part Numbers 217

**UHPLC Fittings PEEKTite™ Ti-Lok EXP 218**

Product Data 218  
 Part Numbers 219

**Tubing 221**

**GC 222**

**Stainless Steel 222**  
 Product Data 222  
 Part Numbers 223

**HPLC 224**

**Glass Lined Tubing (GLT™) 224**

Product Data 224  
 Part Numbers 225

**PEEKsil® 226**

Product Data 226  
 Part Numbers 227

**HPLC Hardware 229**

**UHPLC ProteCol® Bio-Inert 229**

Product Data 229  
 Part Numbers 230

**GC and HPLC Fused Silica 232**

Product Data 232  
 Part Numbers 233

**Kits 235**

**MyCapLC™ Kit 235**

Product Data 235  
 Part Numbers 236

**Accessories 237**

**Gas Purifiers 238**

**Advanced Gas Filter System 238**  
 Product Data 238  
 Part Numbers 239

**Hydrocarbon Trap 240**

Product Data 240  
 Part Numbers 241

**Indicating Oxygen Trap 242**

Product Data 242  
 Part Numbers 243

**Moisture Trap 244**

Product Data 244  
 Part Numbers 245

**Oxygen Trap 246**

Product Data 246  
 Part Numbers 247

**Packed Column Moisture Trap 248**

Product Data 248  
 Part Numbers 249

**GC 250**

**Gas and Vapor Sampler 250**

Product Data 250  
 Part Numbers 251

**Syringe Valves 252**

Product Data 252  
 Part Numbers 253

**Valves High Performance 254**

Product Data 254  
 Part Numbers 255



# Syringes



**Greyhound**  
CHROMATOGRAPHY  
AND ALLIED CHEMICALS

## Syringes | Diamond Headspace

### Higher Limits in Headspace Analysis

SGE Diamond Headspace Syringes feature a unique energized plunger tip design to maintain a gas tight seals for outstanding performance with temperature cycling and high temperatures. The PTFE plunger tip enables the use of a broader range of samples and solvents compared with polymers used in plungers of other high temperature syringes. This provides greater flexibility for your headspace analyses and a longer lasting syringe.

#### Features and Benefits

- Outstanding reproducibility (%RSD) maintained during temperature cycling.
- Highest operating temperature.
- Save time and improve analysis workflow.
- No dead space.

#### Recommended Applications

GC Headspace injections.

#### Product Specifications

Available in 1 mL, 2.5 mL and 5 mL for CTC and Thermo RSH autosamplers.

Accuracy and Reproducibility	± 1 % (displaced volume)
Temperature Range	25-150 °C
International Standards Traceability	

For more information about this product visit [www.sge.com](http://www.sge.com) or contact [techsupport@sge.com](mailto:techsupport@sge.com).



## Syringes | Diamond Headspace

### New Limits in Headspace Analysis

Part Number	Part Description and Detail	Replacement Plunger
<b>CTC Head Space</b>		
008131	1 mL Fixed Needle CTC Head Space Syringe with Energized GT Plunger and 5.6 cm 0.63 mm OD Side-hole Needle	031841
008136	1 mL Fixed Needle CTC Head Space Syringe with Energized GT Plunger and 5.6 cm 0.47 mm OD Side-hole Needle	031841
008631	2.5 mL Fixed Needle CTC Head Space Syringe with Energized GT Plunger and 5.6 cm 0.63 mm OD Side-hole Needle	031851
008636	2.5 mL Fixed Needle CTC Head Space Syringe with Energized GT Plunger and 5.6 cm 0.47 mm OD Side-hole Needle	031851
<b>CTC RTC &amp; Thermo RSH Head Space</b>		
008155	1 mL Fixed Needle CTC RTC & Thermo RSH Head Space Syringe with Energized GT Plunger and 6.5 cm 0.63 mm OD Side-hole Needle	032841
008655	2.5 mL Fixed Needle CTC RTC & Thermo RSH Head Space Syringe with Energized GT Plunger and 6.5 cm 0.63 mm OD Side-hole Needle	032846

For more information about this product visit [www.sge.com](http://www.sge.com) or contact [techsupport@sge.com](mailto:techsupport@sge.com).

## Syringes | Diamond MS

### The Choice for Sensitivity

Understanding how important your MS results are, and how precious your sample is, the SGE Diamond MS syringe and needle range is designed to improve the sensitivity of your MS results.

#### Features and Benefits

- Lowest syringe carryover.
- Reduced non specific sample interaction and increased analyte recovery.
- Ultra smooth removable needles with choice of surface treatment.

#### Recommended Applications

Diamond MS syringes and needles are MS ready.

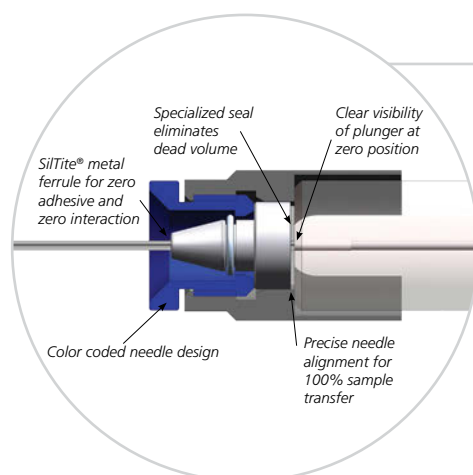

#### Product Specifications

Available in 10  $\mu\text{L}$  to 500  $\mu\text{L}$  manual syringes, 10  $\mu\text{L}$  to 100  $\mu\text{L}$  CTC and Thermo RSH autosampler syringes, 10  $\mu\text{L}$  and 25  $\mu\text{L}$  Agilent autosampler syringes, 10  $\mu\text{L}$  Shimadzu autosamplers syringes. Ultra Smooth, Ultra Smooth Hydrophilic, and Ultra Smooth Hydrophobic needles.

Accuracy and Reproducibility	$\pm 1\%$ (displaced volume)
Temperature Range	5-120 $^{\circ}\text{C}$
International Standards Traceability	

For more information about this product visit [www.sge.com](http://www.sge.com) or contact [techsupport@sge.com](mailto:techsupport@sge.com).



## Syringes | Diamond MS

### The Choice for Sensitivity

#### Diamond MS Syringes (supplied without needles)

Part Number	Part Description and Detail	Replacement Plunger
<b>Manual</b>		
002750	10 µL Removable Needle Diamond MS Syringe with GT Plunger	0355101
003750	25 µL Removable Needle Diamond MS Syringe with GT Plunger	0355102
004750	50 µL Removable Needle Diamond MS Syringe with GT Plunger	0355105
005750	100 µL Removable Needle Diamond MS Syringe with GT Plunger	0355110
006750	250 µL Removable Needle Diamond MS Syringe with GT Plunger	0355120
007750	500 µL Removable Needle Diamond MS Syringe with GT Plunger	0355150
<b>Agilent</b>		
002760	10 µL Removable Needle Agilent Diamond MS Syringe with GT Plunger	0355160
003760	25 µL Removable Needle Agilent Diamond MS Syringe with GT Plunger	0355161
<b>CTC</b>		
002770	10 µL Removable Needle CTC Diamond MS Syringe with GT Plunger	0355170
003770	25 µL Removable Needle CTC Diamond MS Syringe with GT Plunger	0355171
004770	50 µL Removable Needle CTC Diamond MS Syringe with GT Plunger	0355172
005770	100 µL Removable Needle CTC Diamond MS Syringe with GT Plunger	0355173
<b>CTC RTC &amp; Thermo RSH</b>		
002790	10 µL Removable Needle CTC RTC & Thermo RSH Diamond MS Syringe with GT Plunger	0355190
003790	25 µL Removable Needle CTC RTC & Thermo RSH Diamond MS Syringe with GT Plunger	0355191
004790	50 µL Removable Needle CTC RTC & Thermo RSH Diamond MS Syringe with GT Plunger	0355192
005790	100 µL Removable Needle CTC RTC & Thermo RSH Diamond MS Syringe with GT Plunger	0355193
<b>Shimadzu</b>		
002780	10 µL Removable Needle Shimadzu Diamond MS Syringe with GT Plunger	0355180

#### Needles for Diamond MS Syringes

Part Number	Part Description and Detail
<b>Ultra Smooth Hydrophilic Needles</b>	
<b>Manual and Autosampler</b>	
0355310	Ultra Smooth Hydrophilic Coated 50 mm 0.47 mm OD 0.11 mm ID Bevel Tipped Needle for 10-50 µL Manual Diamond MS Syringes
0355311	Ultra Smooth Hydrophilic Coated 50 mm 0.50 mm OD 0.20 mm ID Bevel Tipped Needle for 10-50 µL Manual Diamond MS Syringes
0355312	Ultra Smooth Hydrophilic Coated 50 mm 0.50 mm OD 0.20 mm ID Bevel Tipped Needle for 100-500 µL Manual Diamond MS Syringes
0355313	Ultra Smooth Hydrophilic Coated 50 mm 0.63 mm OD 0.32 mm ID Bevel Tipped Needle for 100-500 µL Manual Diamond MS Syringes
0355210	Ultra Smooth Hydrophilic Coated 51 mm 0.72 mm OD 0.17 mm ID LC Tipped Needle for 10-50 µL Manual and Autosampler Diamond MS Syringes
0355211	Ultra Smooth Hydrophilic Coated 51 mm 0.72 mm OD 0.17 mm ID LC Tipped Needle for 100-500 µL Manual and Autosampler Diamond MS Syringes
0355213	Ultra Smooth Hydrophilic Coated 51 mm 0.72 mm OD 0.37 mm ID LC Tipped Needle for 100-500 µL Manual and Autosampler Diamond MS Syringes
0355215	Ultra Smooth Hydrophilic Coated 57 mm 0.72 mm OD 0.17 mm ID LC Tipped Needle for 10-50 µL Manual and Autosampler Diamond MS Syringes
0355216	Ultra Smooth Hydrophilic Coated 57 mm 0.72 mm OD 0.17 mm ID LC Tipped Needle for 100-500 µL Manual and Autosampler Diamond MS Syringes
<b>Agilent &amp; Shimadzu GC Autosampler</b>	
0355411	Ultra Smooth Hydrophilic Coated 42 mm 0.63 mm OD 0.11 mm ID Cone Tipped Needle for 10-50 µL Agilent & Shimadzu GC Autosampler Diamond MS Syringes
0355410	Ultra Smooth Hydrophilic Coated 42 mm 0.63 mm OD 0.24 mm ID Cone Tipped Needle for 10-50 µL Agilent & Shimadzu GC Autosampler Diamond MS Syringes
<b>CTC GC Autosampler</b>	
0355512	Ultra Smooth Hydrophilic Coated 50 mm 0.63 mm OD 0.11 mm ID Cone Tipped Needle for 10-50 µL CTC GC Autosampler Diamond MS Syringes
0355510	Ultra Smooth Hydrophilic Coated 50 mm 0.63 mm OD 0.24 mm ID Cone Tipped Needle for 10-50 µL CTC GC Autosampler Diamond MS Syringes
0355511	Ultra Smooth Hydrophilic Coated 50 mm 0.63 mm OD 0.24 mm ID Cone Tipped Needle for 100-500 µL CTC GC Autosampler Diamond MS Syringes
<b>CTC RTC &amp; Thermo RSH GC Autosampler</b>	
0355612	Ultra Smooth Hydrophilic Coated 57 mm 0.63 mm OD 0.11 mm ID Cone Tipped Needle for 10-50 µL CTC RTC & Thermo RSH GC Autosampler Diamond MS Syringes
0355610	Ultra Smooth Hydrophilic Coated 57 mm 0.63 mm OD 0.24 mm ID Cone Tipped Needle for 10-50 µL CTC RTC & Thermo RSH GC Autosampler Diamond MS Syringes
0355611	Ultra Smooth Hydrophilic Coated 57 mm 0.63 mm OD 0.24 mm ID Cone Tipped Needle for 100-500 µL CTC RTC & Thermo RSH GC Autosampler Diamond MS Syringes

Part Number	Part Description and Detail
<b>Ultra Smooth Hydrophobic Needles</b>	
<b>Manual and Autosampler</b>	
0355320	Ultra Smooth Hydrophobic Coated 50 mm 0.47 mm OD 0.11 mm ID Bevel Tipped Needle for 10-50 µL Manual Diamond MS Syringes
0355321	Ultra Smooth Hydrophobic Coated 50 mm 0.50 mm OD 0.20 mm ID Bevel Tipped Needle for 10-50 µL Manual Diamond MS Syringes
0355322	Ultra Smooth Hydrophobic Coated 50 mm 0.50 mm OD 0.20 mm ID Bevel Tipped Needle for 100-500 µL Manual Diamond MS Syringes
0355323	Ultra Smooth Hydrophobic Coated 50 mm 0.63 mm OD 0.32 mm ID Bevel Tipped Needle for 100-500 µL Manual Diamond MS Syringes
0355220	Ultra Smooth Hydrophobic Coated 51 mm 0.72 mm OD 0.17 mm ID LC Tipped Needle for 10-50 µL Manual and Autosampler Diamond MS Syringes
0355221	Ultra Smooth Hydrophobic Coated 51 mm 0.72 mm OD 0.17 mm ID LC Tipped Needle for 100-500 µL Manual and Autosampler Diamond MS Syringes
0355223	Ultra Smooth Hydrophobic Coated 51 mm 0.72 mm OD 0.37 mm ID LC Tipped Needle for 100-500 µL Manual and Autosampler Diamond MS Syringes
0355225	Ultra Smooth Hydrophobic Coated 57 mm 0.72 mm OD 0.17 mm ID LC Tipped Needle for 10-50 µL Manual and Autosampler Diamond MS Syringes
0355226	Ultra Smooth Hydrophobic Coated 57 mm 0.72 mm OD 0.17 mm ID LC Tipped Needle for 100-500 µL Manual and Autosampler Diamond MS Syringes
<b>Agilent &amp; Shimadzu GC Autosampler</b>	
0355421	Ultra Smooth Hydrophobic Coated 42 mm 0.63 mm OD 0.11 mm ID Cone Tipped Needle for 10-50 µL Agilent & Shimadzu GC Autosampler Diamond MS Syringes
0355420	Ultra Smooth Hydrophobic Coated 42 mm 0.63 mm OD 0.24 mm ID Cone Tipped Needle for 10-50 µL Agilent & Shimadzu GC Autosampler Diamond MS Syringes
<b>CTC GC Autosampler</b>	
0355522	Ultra Smooth Hydrophobic Coated 50 mm 0.63 mm OD 0.11 mm ID Cone Tipped Needle for 10-50 µL CTC GC Autosampler Diamond MS Syringes
0355520	Ultra Smooth Hydrophobic Coated 50 mm 0.63 mm OD 0.24 mm ID Cone Tipped Needle for 10-50 µL CTC GC Autosampler Diamond MS Syringes
0355521	Ultra Smooth Hydrophobic Coated 50 mm 0.63 mm OD 0.24 mm ID Cone Tipped Needle for 100-500 µL CTC GC Autosampler Diamond MS Syringes
<b>CTC RTC &amp; Thermo RSH GC Autosampler</b>	
0355622	Ultra Smooth Hydrophobic Coated 57 mm 0.63 mm OD 0.11 mm ID Cone Tipped Needle for 10-50 µL CTC RTC & Thermo RSH GC Autosampler Diamond MS Syringes
0355620	Ultra Smooth Hydrophobic Coated 57 mm 0.63 mm OD 0.24 mm ID Cone Tipped Needle for 10-50 µL CTC RTC & Thermo RSH GC Autosampler Diamond MS Syringes
0355621	Ultra Smooth Hydrophobic Coated 57 mm 0.63 mm OD 0.24 mm ID Cone Tipped Needle for 100-500 µL CTC RTC & Thermo RSH GC Autosampler Diamond MS Syringes
<b>Ultra Smooth Needles</b>	
<b>Manual and Autosampler</b>	
0355330	Ultra Smooth 50 mm 0.47 mm OD 0.11 mm ID Bevel Tipped Needle for 10-50 µL Manual Diamond MS Syringes
0355331	Ultra Smooth 50 mm 0.50 mm OD 0.20 mm ID Bevel Tipped Needle for 10-50 µL Manual Diamond MS Syringes
0355332	Ultra Smooth 50 mm 0.50 mm OD 0.20 mm ID Bevel Tipped Needle for 100-500 µL Manual Diamond MS Syringes
0355333	Ultra Smooth 50 mm 0.63 mm OD 0.32 mm ID Bevel Tipped Needle for 100-500 µL Manual Diamond MS Syringes
0355230	Ultra Smooth 51 mm 0.72 mm OD 0.17 mm ID LC Tipped Needle for 10-50 µL Manual and Autosampler Diamond MS Syringes
0355231	Ultra Smooth 51 mm 0.72 mm OD 0.17 mm ID LC Tipped Needle for 100-500 µL Manual and Autosampler Diamond MS Syringes
0355233	Ultra Smooth 51 mm 0.72 mm OD 0.37 mm ID LC Tipped Needle for 100-500 µL Manual and Autosampler Diamond MS Syringes
0355235	Ultra Smooth 57 mm 0.72 mm OD 0.17 mm ID LC Tipped Needle for 10-50 µL Manual and Autosampler Diamond MS Syringes
0355236	Ultra Smooth 57 mm 0.72 mm OD 0.17 mm ID LC Tipped Needle for 100-500 µL Manual and Autosampler Diamond MS Syringes
<b>Agilent &amp; Shimadzu GC Autosampler</b>	
0355431	Ultra Smooth 42 mm 0.63 mm OD 0.11 mm ID Cone Tipped Needle for 10-50 µL Agilent & Shimadzu GC Autosampler Diamond MS Syringes
0355430	Ultra Smooth 42 mm 0.63 mm OD 0.24 mm ID Cone Tipped Needle for 10-50 µL Agilent & Shimadzu GC Autosampler Diamond MS Syringes
<b>CTC GC Autosampler</b>	
0355532	Ultra Smooth 50 mm 0.63 mm OD 0.11 mm ID Cone Tipped Needle for 10-50 µL CTC GC Autosampler Diamond MS Syringes
0355530	Ultra Smooth 50 mm 0.63 mm OD 0.24 mm ID Cone Tipped Needle for 10-50 µL CTC GC Autosampler Diamond MS Syringes
0355531	Ultra Smooth 50 mm 0.63 mm OD 0.24 mm ID Cone Tipped Needle for 100-500 µL CTC GC Autosampler Diamond MS Syringes
<b>CTC RTC &amp; Thermo RSH GC Autosampler</b>	
0355632	Ultra Smooth 57 mm 0.63 mm OD 0.11 mm ID Cone Tipped Needle for 10-50 µL CTC RTC & Thermo RSH GC Autosampler Diamond MS Syringes
0355630	Ultra Smooth 57 mm 0.63 mm OD 0.24 mm ID Cone Tipped Needle for 10-50 µL CTC RTC & Thermo RSH GC Autosampler Diamond MS Syringes
0355631	Ultra Smooth 57 mm 0.63 mm OD 0.24 mm ID Cone Tipped Needle for 100-500 µL CTC RTC & Thermo RSH GC Autosampler Diamond MS Syringes

For more information visit [www.sge.com](http://www.sge.com) or contact [techsupport@sge.com](mailto:techsupport@sge.com).



## Syringes | GC Autosampler

### Diamond Syringe - Syringe Brilliance

The SGE comprehensive range of GC autosampler syringes are designed and tested to meet critical autosampler specifications.

#### Features and Benefits

Unique plunger design minimizes bending and seizing, and the cone tip needle point style has been developed specifically to withstand multiple fast septum injections.

#### Recommended Applications

Metal plungers are individually fitted to the syringe glass barrel for a perfect “feel”, optimized life with minimal carry over, a liquid tight seal between the barrel and plunger and excellent performance.

PTFE tipped replaceable plunger syringes reduce the risk of plunger seizing when working with dirty samples, reducing instrument downtime, and minimizing the risk of instrument shutdown during the processing of large batches of samples.

#### Product Specifications

Wide range of fixed needle and removable needle options available for Agilent, CTC, PerkinElmer, Shimadzu, Thermo Scientific, and Varian/Bruker autosamplers. PTFE tipped replaceable plunger versions are available for use with gas and headspace samples.

In addition, multi-packs are available for most popular autosamplers.

<b>For NanoVolume Syringes</b>	
Accuracy and Reproducibility	± 2 % (displaced volume)
Temperature Range	5-70 °C
International Standards Traceability	
<b>For Fixed Needle Syringes</b>	
Accuracy and Reproducibility	± 1 % (displaced volume)
Temperature Range	5-70 °C
International Standards Traceability	
<b>For Removable Needle Syringes</b>	
Accuracy and Reproducibility	± 1 % (displaced volume)
Temperature Range	5-120 °C
International Standards Traceability	

For more information about this product visit [www.sge.com](http://www.sge.com) or contact [techsupport@sge.com](mailto:techsupport@sge.com).



## Syringes | GC Autosampler

### Diamond Syringe - Syringe Brilliance

Part Number	Part Description and Detail	Replacement Needle (* Needle & Plunger Kit)	Replacement Plunger
<b>Agilent</b>			
000400	0.5 µL NanoVolume Agilent Syringe with 4.2 cm 0.47 mm OD Cone Tipped Needle	033708*	
000410	0.5 µL NanoVolume Agilent Syringe with 4.2 cm 0.63 mm OD Cone Tipped Needle	033715*	
000415	0.5 µL NanoVolume Agilent Syringe with 4.2 cm 0.63/0.47 mm OD Dual Gauge Cone Tipped Needle	033730*	
000610	1.0 µL NanoVolume Agilent Syringe with 4.2 cm 0.63 mm OD Cone Tipped Needle	034715*	
001800	5 µL Fixed Needle Agilent Syringe with 4.2 cm 0.47 mm OD Cone Tipped Needle		
001804	5 µL Fixed Needle Agilent Syringe with 4.2 cm 0.47 mm OD Cone Tipped Needle PK6		
001810	5 µL Fixed Needle Agilent Syringe with 4.2 cm 0.63 mm OD Cone Tipped Needle		
001814	5 µL Fixed Needle Agilent Syringe with 4.2 cm 0.63 mm OD Cone Tipped Needle PK6		
001821	5 µL Fixed Needle Agilent Syringe with 4.2 cm 0.63/0.47 mm OD Cone Tipped Dual Gauge Needle		
001822	5 µL Fixed Needle Agilent Syringe with 4.2 cm 0.63/0.47 mm OD Cone Tipped Dual Gauge Needle PK6		
002800	10 µL Fixed Needle Agilent Syringe with 4.2 cm 0.47 mm OD Cone Tipped Needle		
002804	10 µL Fixed Needle Agilent Syringe with 4.2 cm 0.47 mm OD Cone Tipped Needle PK6		
002831	10 µL Fixed Needle Agilent Syringe with Superflex Plunger and 4.2 cm 0.47 mm OD Cone Tipped Needle PK6		
002811	10 µL Fixed Needle Agilent Syringe with 4.2 cm 0.63 mm OD Side Hole Needle		
002810	10 µL Fixed Needle Agilent Syringe with 4.2 cm 0.63 mm OD Cone Tipped Needle		
002814	10 µL Fixed Needle Agilent Syringe with 4.2 cm 0.63 mm OD Cone Tipped Needle PK6		
002838	10 µL Fixed Needle Agilent Syringe with Superflex Plunger and 4.2 cm 0.63 mm OD Cone Tipped Needle PK6		
002813	10 µL Fixed Needle Agilent Syringe with 4.2 cm 0.63 mm OD Cone Tipped Needle PK25		
002821	10 µL Fixed Needle Agilent Syringe with 4.2 cm 0.63/0.47 mm OD Cone Tipped Dual Gauge Needle		
002822	10 µL Fixed Needle Agilent Syringe with 4.2 cm 0.63/0.47 mm OD Cone Tipped Dual Gauge Needle PK6		
002824	10 µL Fixed Needle Agilent Syringe with 4.2 cm 0.63/0.47 mm OD Cone Tipped Dual Gauge Needle PK25		
002812	10 µL Fixed Needle Agilent Syringe with GT Plunger & 4.2 cm 0.63 mm OD Cone Tipped Needle		031808
002816	10 µL Fixed Needle Agilent Syringe with GT Plunger & 4.2 cm 0.63 mm OD Cone Tipped Needle PK25		031808
002826	10 µL Fixed Needle Agilent Syringe with GT Plunger & 4.2 cm 0.63/0.47 mm OD Cone Tipped Dual Gauge Needle		031808
002827	10 µL Fixed Needle Agilent Syringe with GT Plunger & 4.2 cm 0.63/0.47 mm OD Cone Tipped Dual Gauge Needle PK6		031808
002805	10 µL Removable Needle Agilent Syringe with 4.2 cm 0.47 mm OD Cone Tipped Needle	037715	
002815	10 µL Removable Needle Agilent Syringe with 4.2 cm 0.63 mm OD Cone Tipped Needle	037717	
002760	10 µL Removable Needle Agilent Diamond MS Syringe with GT Plunger	Refer Diamond MS PDPN-1005-G	0355160
002820	10 µL Removable Needle Agilent Syringe with GT Plunger & 4.2 cm 0.63 mm OD Cone Tipped Needle PK10	037717	031809
002829	10 µL Removable Needle Agilent Syringe with GT Plunger & 4.2 cm 0.63/0.47 mm OD Cone Tipped Dual Gauge Needle	037730	031809
003668	25 µL Fixed Needle Agilent Syringe with GT Plunger & 4.2 cm 0.63/0.47 mm OD Cone Tipped Dual Gauge Needle		
003760	25 µL Removable Needle Agilent Diamond MS Syringe with GT Plunger	Refer Diamond MS PDPN-1005-G	0355161
004668	50 µL Fixed Needle Agilent Syringe with GT Plunger & 4.2 cm 0.63/0.47 mm OD Cone Tipped Dual Gauge Needle		
004665	50 µL Removable Needle Agilent Syringe with 4.2 cm 0.63 mm OD Cone Tipped Needle	038717	
005668	100 µL Fixed Needle Agilent Syringe with GT Plunger & 4.2 cm 0.63/0.47 mm OD Cone Tipped Dual Gauge Needle		031823
005292	100 µL Removable Needle Agilent MEPS Syringe with GT Plunger	Refer MEPS PDPN-1030-G	0318263
006293	250 µL Removable Needle Agilent MEPS Syringe with GT Plunger	Refer MEPS PDPN-1030-G	0318303

Part Number	Part Description and Detail	Replacement Needle (* Needle & Plunger Kit)	Replacement Plunger
<b>CTC</b>			
002700	10 µL Fixed Needle CTC Syringe with 5 cm 0.47 mm OD Cone Tipped Needle		
002983	10 µL Fixed Needle CTC Syringe with GT Plunger & 5 cm 0.72 mm OD Side Hole Needle		031803 (PK1) 0318120 (PK2)
002770	10 µL Removable Needle CTC Diamond MS Syringe with GT Plunger	Refer Diamond MS PDPN-1005-G	0355170
003700	25 µL Fixed Needle CTC Syringe with GT Plunger & 5 cm 0.47 mm OD Cone Tipped Needle		0318922
003770	25 µL Removable Needle CTC Diamond MS Syringe with GT Plunger	Refer Diamond MS PDPN-1005-G	0355171
004770	50 µL Removable Needle CTC Diamond MS Syringe with GT Plunger	Refer Diamond MS PDPN-1005-G	0355172
005700	100 µL Fixed Needle CTC Syringe with GT Plunger & 5 cm 0.47 mm OD Cone Tipped Needle		0318261
005770	100 µL Removable Needle CTC Diamond MS Syringe with GT Plunger	Refer Diamond MS PDPN-1005-G	0355173
006700	250 µL Fixed Needle CTC Syringe with GT Plunger & 5 cm 0.47 mm OD Cone Tipped Needle		0318926
006292	250 µL Removable Needle CTC MEPS Syringe with GT Plunger	Refer MEPS PDPN-1030-G	0318301
008136	1 mL Fixed Needle CTC Head Space Syringe with Energized GT Plunger & 5.6 cm 0.47 mm OD Side Hole Needle		031841
008131	1 mL Fixed Needle CTC Head Space Syringe with Energized GT Plunger & 5.6 cm 0.63 mm OD Side Hole Needle		031841
008636	2.5 mL Fixed Needle CTC Head Space Syringe with Energized GT Plunger & 5.6 cm 0.47 mm OD Side Hole Needle		031851
008631	2.5 mL Fixed Needle CTC Head Space Syringe with Energized GT Plunger & 5.6 cm 0.63 mm OD Side Hole Needle		031851
<b>PerkinElmer</b>			
000475	0.5 µL NanoVolume PerkinElmer Syringe with 7 cm 0.47 mm OD Cone Tipped Needle	033750*	
000478	0.5 µL NanoVolume PerkinElmer Syringe with 7 cm 0.63 mm OD Cone Tipped Needle	033765*	
001953	5 µL Fixed Needle PerkinElmer Syringe with 7 cm 0.47 mm OD Cone Tipped Needle		
001954	5 µL Fixed Needle PerkinElmer Syringe with 7 cm 0.63 mm OD Cone Tipped Needle		
001955	5 µL Fixed Needle PerkinElmer Syringe with GT Plunger & 7 cm 0.47 mm OD Cone Tipped Needle		031807
001957	5 µL Fixed Needle PerkinElmer Syringe with GT Plunger & 7 cm 0.63 mm OD Cone Tipped Needle		031807
004670	50 µL Fixed Needle PerkinElmer Syringe with 7 cm 0.63 mm OD Cone Tipped Needle		
<b>Shimadzu</b>			
000440	0.5 µL NanoVolume Shimadzu Syringe with 4.2 cm 0.47 mm OD Cone Tipped Needle	033738*	
000445	0.5 µL NanoVolume Shimadzu Syringe with 4.2 cm 0.63 mm OD Cone Tipped Needle	033745*	
002897	10 µL Removable Needle Shimadzu Syringe with 4.2 cm 0.47 mm OD Cone Tipped Needle	037745	
002898	10 µL Removable Needle Shimadzu Syringe with 4.2 cm 0.63 mm OD Cone Tipped Needle	037747	
002780	10 µL Removable Needle Shimadzu Diamond MS Syringe with GT Plunger	Refer Diamond MS PDPN-1005-G	0355180
002902	10 µL Removable Needle Shimadzu Syringe with GT Plunger & 4.2 cm 0.63 mm OD Cone Tipped Needle	037747	031798
<b>CTC/Thermo</b>			
000490	0.5 µL NanoVolume CTC/Thermo Syringe with 5 cm 0.47 mm OD Cone Tipped Needle	033770*	
000492	0.5 µL NanoVolume CTC/Thermo Syringe with 5 cm 0.63 mm OD Cone Tipped Needle	033772*	
000790	2.0 µL NanoVolume CTC/Thermo Syringe with 5.0 cm 0.63 mm OD Cone Tipped Needle	034905*	
001982	5 µL Fixed Needle CTC/Thermo Syringe with 5 cm 0.47 mm OD Cone Tipped Needle		
0019821	5 µL Fixed Needle CTC/Thermo (Classic Button) Syringe with 5 cm 0.47 mm OD Cone Tipped Needle		
001981	5 µL Fixed Needle CTC/Thermo Syringe with 5 cm 0.63 mm OD Cone Tipped Needle		
0019811	5 µL Fixed Needle CTC/Thermo (Classic Button) Syringe with 5 cm 0.63 mm OD Cone Tipped Needle		
001984	5 µL Removable Needle CTC/Thermo Syringe with 5 cm 0.63 mm OD Cone Tipped Needle	36011	
002980	10 µL Fixed Needle CTC/Thermo Syringe with 5 cm 0.47 mm OD Cone Tipped Needle		
0029801	10 µL Fixed Needle CTC/Thermo (Classic Button) Syringe with 5 cm 0.47 mm OD Cone Tipped Needle		
002986	10 µL Fixed Needle CTC/Thermo Syringe with 5 cm 0.47 mm OD Cone Tipped Needle PK6		
0029861	10 µL Fixed Needle CTC/Thermo (Classic Button) Syringe with 5 cm 0.47 mm OD Cone Tipped Needle PK6		
002967	10 µL Fixed Needle CTC/Thermo Syringe with 5 cm 0.5 mm OD Cone Tipped Needle		
0029671	10 µL Fixed Needle CTC/Thermo (Classic Button) Syringe with 5 cm 0.5 mm OD Cone Tipped Needle		
002981	10 µL Fixed Needle CTC/Thermo Syringe with 5 cm 0.63 mm OD Cone Tipped Needle		
002971	10 µL Fixed Needle CTC/Thermo Syringe with 5 cm 0.63 mm OD Cone Tipped Needle PK6		
002992	10 µL Fixed Needle CTC/Thermo Syringe with 8 cm 0.47 mm OD Cone Tipped Needle		
0029781	10 µL Fixed Needle CTC/Thermo (Classic Button) Syringe with 7 cm 0.47 mm OD Cone Tipped Needle		
0029921	10 µL Fixed Needle CTC/Thermo (Classic Button) Syringe with 8 cm 0.47 mm OD Cone Tipped Needle		
0029891	10 µL Fixed Needle CTC/Thermo (Classic Button) Syringe with 8 cm 0.63 mm OD Cone Tipped Needle		
0029741	10 µL Fixed Needle CTC/Thermo (Classic Button) Syringe with 8 cm 0.72 mm OD Cone Tipped Needle		
002977	10 µL Fixed Needle CTC/Thermo Syringe with GT Plunger & 5 cm 0.47 mm OD Cone Tipped Needle		031803 (PK1) 0318120 (PK2)
002976	10 µL Fixed Needle CTC/Thermo Syringe with GT Plunger & 5 cm 0.47 mm OD Cone Tipped Needle PK6		031803 (PK1) 0318120 (PK2)

Part Number	Part Description and Detail	Replacement Needle (* Needle & Plunger Kit)	Replacement Plunger
0029771	10 µL Fixed Needle CTC/Thermo (Classic Button) Syringe with GT Plunger & 5 cm 0.47 mm OD Cone Tipped Needle		03181201
0029761	10 µL Fixed Needle CTC/Thermo (Classic Button) Syringe with GT Plunger & 5 cm 0.47 mm OD Cone Tipped Needle PK6		03181201
002987	10 µL Fixed Needle CTC/Thermo Syringe with GT Plunger & 5 cm 0.63 mm OD Cone Tipped Needle		031803 (PK1) 0318120 (PK2)
002972	10 µL Fixed Needle CTC/Thermo Syringe with GT Plunger & 5 cm 0.63 mm OD Cone Tipped Needle PK6		031803 (PK1) 0318120 (PK2)
0029871	10 µL Fixed Needle CTC/Thermo (Classic Button) Syringe with GT Plunger & 5 cm 0.63 mm OD Cone Tipped Needle		03181201
002982	10 µL Removable Needle CTC/Thermo Syringe with 5 cm 0.47 mm OD Cone Tipped Needle	037010	
002984	10 µL Removable Needle CTC/Thermo Syringe with 5 cm 0.63 mm OD Cone Tipped Needle	037787	
0029841	10 µL Removable Needle CTC/Thermo (Classic Button) Syringe with 5 cm 0.63 mm OD Cone Tipped Needle	037787	
002993	10 µL Removable Needle CTC/Thermo Syringe with 8 cm 0.47 mm OD Cone Tipped Needle	031535	
0029931	10 µL Removable Needle CTC/Thermo (Classic Button) Syringe with 8 cm 0.47 mm OD Cone Tipped Needle	031535	
002985	10 µL Removable Needle CTC/Thermo Syringe with GT Plunger & 5 cm 0.47 mm OD Cone Tipped Needle	037010	0318121
003987	25 µL Fixed Needle CTC/Thermo Syringe with GT Plunger & 5 cm 0.63 mm OD Cone Tipped Needle		031817
0039871	25 µL Fixed Needle CTC/Thermo (Classic Button) Syringe with GT Plunger & 5 cm 0.63 mm OD Cone Tipped Needle		0318171
003988	25 µL Removable Needle CTC/Thermo Syringe with GT Plunger & 5 cm 0.47 mm OD Side Hole Needle	038749	031816
005335	100 µL Fixed Needle CTC/Thermo Syringe with GT Plunger & 5 cm 0.63 mm OD Cone Tipped Needle		0318261
005291	100 µL Removable Needle CTC/Thermo MEPS Syringe with GT Plunger	Refer MEPS PDPN-1030-G	
005333	100 µL Removable Needle CTC/Thermo Syringe with GT Plunger & 5 cm 0.47 mm OD Cone Tipped Needle	038732	031826
<b>CTC RTC &amp; Thermo RSH</b>			
000480	0.5 µL NanoVolume CTC RTC & Thermo RSH Syringe with 5.7 cm 0.63 mm OD Cone Tipped Needle	033780*	
000680	1.0 µL NanoVolume CTC RTC & Thermo RSH Syringe with 5.7 cm 0.63 mm OD Cone Tipped Needle	034780*	
001865	5 µL Fixed Needle CTC RTC & Thermo RSH Syringe with 5.7 cm 0.47 mm OD Cone Tipped Needle		
001861	5 µL Fixed Needle CTC RTC & Thermo RSH Syringe with 5.7 cm 0.63 mm OD Cone Tipped Needle		
001867	5 µL Fixed Needle CTC RTC & Thermo RSH Syringe with 8.5 cm 0.47 mm OD Cone Tipped Needle		
001863	5 µL Fixed Needle CTC RTC & Thermo RSH Syringe with 8.5 cm 0.63 mm OD Cone Tipped Needle		
001875	5 µL Removable Needle CTC RTC & Thermo RSH Syringe with 5.7 cm 0.47 mm OD Cone Tipped Needle	036875	
001871	5 µL Removable Needle CTC RTC & Thermo RSH Syringe with 5.7 cm 0.63 mm OD Cone Tipped Needle	036871	
001877	5 µL Removable Needle CTC RTC & Thermo RSH Syringe with 8.5 cm 0.47 mm OD Cone Tipped Needle	036877	
001873	5 µL Removable Needle CTC RTC & Thermo RSH Syringe with 8.5 cm 0.63 mm OD Cone Tipped Needle	036873	
002865	10 µL Fixed Needle CTC RTC & Thermo RSH Syringe with 5.7 cm 0.47 mm OD Cone Tipped Needle		
002861	10 µL Fixed Needle CTC RTC & Thermo RSH Syringe with 5.7 cm 0.63 mm OD Cone Tipped Needle		
002869	10 µL Fixed Needle CTC RTC & Thermo RSH Syringe with 8.5 cm 0.47 mm OD Bevel Tipped Needle		
002867	10 µL Fixed Needle CTC RTC & Thermo RSH Syringe with 8.5 cm 0.47 mm OD Cone Tipped Needle		
002863	10 µL Fixed Needle CTC RTC & Thermo RSH Syringe with 8.5 cm 0.63 mm OD Cone Tipped Needle		
002866	10 µL Fixed Needle CTC RTC & Thermo RSH Syringe with GT Plunger & 5.7 cm 0.47 mm OD Cone Tipped Needle		032810
002862	10 µL Fixed Needle CTC RTC & Thermo RSH Syringe with GT Plunger & 5.7 cm 0.63 mm OD Cone Tipped Needle		032810
002868	10 µL Fixed Needle CTC RTC & Thermo RSH Syringe with GT Plunger & 8.5 cm 0.47 mm OD Cone Tipped Needle		032810
002864	10 µL Fixed Needle CTC RTC & Thermo RSH Syringe with GT Plunger & 8.5 cm 0.63 mm OD Cone Tipped Needle		032810
002875	10 µL Removable Needle CTC RTC & Thermo RSH Syringe with 5.7 cm 0.47 mm OD Cone Tipped Needle	037875	
002871	10 µL Removable Needle CTC RTC & Thermo RSH Syringe with 5.7 cm 0.63 mm OD Cone Tipped Needle	037871	
002877	10 µL Removable Needle CTC RTC & Thermo RSH Syringe with 8.5 cm 0.47 mm OD Cone Tipped Needle	037877	
002873	10 µL Removable Needle CTC RTC & Thermo RSH Syringe with 8.5 cm 0.63 mm OD Cone Tipped Needle	037873	
002790	10 µL Removable Needle CTC RTC & Thermo RSH Diamond MS Syringe with GT Plunger	Refer Diamond MS PDPN-1005-G	0355190
002876	10 µL Removable Needle CTC RTC & Thermo RSH Syringe with GT Plunger & 5.7 cm 0.47 mm OD Cone Tipped Needle	037875	032810
002872	10 µL Removable Needle CTC RTC & Thermo RSH Syringe with GT Plunger & 5.7 cm 0.63 mm OD Cone Tipped Needle	037871	032810
002878	10 µL Removable Needle CTC RTC & Thermo RSH Syringe with GT Plunger & 8.5 cm 0.47 mm OD Cone Tipped Needle	037877	032810
002874	10 µL Removable Needle CTC RTC & Thermo RSH Syringe with GT Plunger & 8.5 cm 0.63 mm OD Cone Tipped Needle	037873	032810
003866	25 µL Fixed Needle CTC RTC & Thermo RSH Syringe with GT Plunger & 5.7 cm 0.47 mm OD Cone Tipped Needle		032815
003862	25 µL Fixed Needle CTC RTC & Thermo RSH Syringe with GT Plunger & 5.7 cm 0.63 mm OD Cone Tipped Needle		032815
003868	25 µL Fixed Needle CTC RTC & Thermo RSH Syringe with GT Plunger & 8.5 cm 0.47 mm OD Cone Tipped Needle		032815
003864	25 µL Fixed Needle CTC RTC & Thermo RSH Syringe with GT Plunger & 8.5 cm 0.63 mm OD Cone Tipped Needle		032815

Part Number	Part Description and Detail	Replacement Needle (* Needle & Plunger Kit)	Replacement Plunger
003790	25 µL Removable Needle CTC RTC & Thermo RSH Diamond MS Syringe with GT Plunger	Refer Diamond MS PDPN-1005-G	0355191
004866	50 µL Fixed Needle CTC RTC & Thermo RSH Syringe with GT Plunger & 5.7 cm 0.47 mm OD Cone Tipped Needle		032821
004862	50 µL Fixed Needle CTC RTC & Thermo RSH Syringe with GT Plunger & 5.7 cm 0.63 mm OD Cone Tipped Needle		032821
004868	50 µL Fixed Needle CTC RTC & Thermo RSH Syringe with GT Plunger & 8.5 cm 0.47 mm OD Cone Tipped Needle		032821
004864	50 µL Fixed Needle CTC RTC & Thermo RSH Syringe with GT Plunger & 8.5 cm 0.63 mm OD Cone Tipped Needle		032821
004790	50 µL Removable Needle CTC RTC & Thermo RSH Diamond MS Syringe with GT Plunger	Refer Diamond MS PDPN-1005-G	0355192
005866	100 µL Fixed Needle CTC RTC & Thermo RSH Syringe with GT Plunger & 5.7 cm 0.47 mm OD Cone Tipped Needle		032825
005862	100 µL Fixed Needle CTC RTC & Thermo RSH Syringe with GT Plunger & 5.7 cm 0.63 mm OD Cone Tipped Needle		032825
005890	100 µL Fixed Needle CTC RTC & Thermo RSH Syringe with GT Plunger & 5.7 cm 0.63 mm OD Side Hole Needle		032825
005868	100 µL Fixed Needle CTC RTC & Thermo RSH Syringe with GT Plunger & 8.5 cm 0.47 mm OD Cone Tipped Needle		032825
005864	100 µL Fixed Needle CTC RTC & Thermo RSH Syringe with GT Plunger & 8.5 cm 0.63 mm OD Cone Tipped Needle		032825
005891	100 µL Fixed Needle CTC RTC & Thermo RSH Syringe with GT Plunger & 8.5 cm 0.63 mm OD Side Hole Needle		032825
005790	100 µL Removable Needle CTC RTC & Thermo RSH Diamond MS Syringe with GT Plunger	Refer Diamond MS PDPN-1005-G	0355193
006866	250 µL Fixed Needle CTC RTC & Thermo RSH Syringe with GT Plunger & 5.7 cm 0.47 mm OD Cone Tipped Needle		032831
006862	250 µL Fixed Needle CTC RTC & Thermo RSH Syringe with GT Plunger & 5.7 cm 0.63 mm OD Cone Tipped Needle		032831
006890	250 µL Fixed Needle CTC RTC & Thermo RSH Syringe with GT Plunger & 5.7 cm 0.63 mm OD Side Hole Needle		032831
006868	250 µL Fixed Needle CTC RTC & Thermo RSH Syringe with GT Plunger & 8.5 cm 0.47 mm OD Cone Tipped Needle		032831
006864	250 µL Fixed Needle CTC RTC & Thermo RSH Syringe with GT Plunger & 8.5 cm 0.63 mm OD Cone Tipped Needle		032831
006891	250 µL Fixed Needle CTC RTC & Thermo RSH Syringe with GT Plunger & 8.5 cm 0.63 mm OD Side Hole Needle		032831
007866	500 µL Fixed Needle CTC RTC & Thermo RSH Syringe with GT Plunger & 5.7 cm 0.47 mm OD Cone Tipped Needle		032835
007862	500 µL Fixed Needle CTC RTC & Thermo RSH Syringe with GT Plunger & 5.7 cm 0.63 mm OD Cone Tipped Needle		032835
007890	500 µL Fixed Needle CTC RTC & Thermo RSH Syringe with GT Plunger & 5.7 cm 0.63 mm OD Side Hole Needle		032835
007868	500 µL Fixed Needle CTC RTC & Thermo RSH Syringe with GT Plunger & 8.5 cm 0.47 mm OD Cone Tipped Needle		032835
007864	500 µL Fixed Needle CTC RTC & Thermo RSH Syringe with GT Plunger & 8.5 cm 0.63 mm OD Cone Tipped Needle		032835
007891	500 µL Fixed Needle CTC RTC & Thermo RSH Syringe with GT Plunger & 8.5 cm 0.63 mm OD Side Hole Needle		032835
008155	1 mL Fixed Needle CTC RTC & Thermo RSH Head Space Syringe with Energized GT Plunger & 6.5 cm 0.63 mm OD Side Hole Needle		032841
008655	2.5 mL Fixed Needle CTC RTC & Thermo RSH Head Space Syringe with Energized GT Plunger & 5.6 cm 0.63 mm OD Side Hole Needle		032846
<b>Varian</b>			
000655	1.0 µL NanoVolume Varian (8035, 8100, 8200) Syringe with 5.1 cm 0.47 mm OD Cone Tipped Needle	034720*	
002950	10 µL Fixed Needle Varian 8400 Syringe with 5 cm 0.47 mm OD Bevel Tipped Needle		
002951	10 µL Fixed Needle Varian 8400/CTC/Thermo (Classic Button) Syringe with 5 cm 0.63 mm OD Cone Tipped Needle		
0029851	10 µL Removable Needle Varian (Classic Button) Syringe with GT Plunger & 5 cm 0.47 mm OD Cone Tipped Needle	037010	03181211
002952	10 µL Removable Needle Varian 8400 Syringe with 5 cm 0.47 mm OD Cone Tipped Needle	037010	
002924	10 µL Removable Needle Varian (8035, 8100, 8200) Syringe with GT Plunger & 5.3 cm mm OD Side Hole Needle	037777 037779 037780 037776	031218

For more information visit [www.sge.com](http://www.sge.com) or contact [techsupport@sge.com](mailto:techsupport@sge.com).

## Syringes | HPLC Autosampler

### Diamond Syringe - Syringe Brilliance

Known for 50 years in chromatography syringes, the SGE range of HPLC autosampler syringes are designed and tested to meet critical autosampler specifications.

#### Product Specifications

Available for CTC, Spark Holland, Hitachi, Thermo Scientific, PerkinElmer, Waters WISP, HPLC autosamplers.

Accuracy and Reproducibility	± 1 % (displaced volume)
Temperature Range	5-70 °C Fixed Needle, 5-120 °C Removable Needle
International Standards Traceability	

For more information about this product visit [www.sge.com](http://www.sge.com) or contact [techsupport@sge.com](mailto:techsupport@sge.com).





## Syringes | HPLC Autosampler

### Diamond Syringe - Syringe Brilliance

Part Number	Part Description and Detail	Replacement Needle	Replacement Plunger
<b>CTC</b>			
002710	10 µL Fixed Needle CTC Syringe with 5.1 cm 0.72 mm OD LC Needle		
003715	25 µL Fixed Needle CTC Syringe with GT Plunger & 5.1 cm 0.72 mm OD LC Needle (8 mm OD barrel)		0318922
004810	50 µL Fixed Needle CTC Syringe with GT Plunger & 5.1 cm 0.72 mm OD LC Needle		031821
005715	100 µL Fixed Needle CTC Syringe with GT Plunger & 5.1 cm 0.72 mm OD LC Needle		0318261
005720	100 µL Fixed Needle CTC Syringe with GT Plunger & 5.1 cm 0.72 mm OD (0.4 mm ID) LC Needle		0318261
006330	250 µL Fixed Needle CTC Syringe with GT Plunger & 5.1 cm 0.72 mm OD (0.4 mm ID) LC Needle	038250	031831
007720	500 µL Fixed Needle CTC Syringe with GT Plunger & 5.1 cm 0.72 mm OD (0.4 mm ID) LC Needle		0318928
<b>CTC/Thermo</b>			
005331	100 µL Fixed Needle CTC/Thermo Syringe with GT Plunger & 5.1 cm 0.72 mm OD LC needle		0318261
005330	100 µL Removable Needle CTC/Thermo Syringe with GT Plunger & 5.1 cm 0.72 mm OD LC needle	038250	031826
<b>CTC RTC &amp; Thermo RSH</b>			
002880	10 µL Removable Needle CTC RTC & Thermo RSH Syringe with GT Plunger & 5.7 cm 0.72 mm OD LC Needle	037880	0318121
008150	1 mL Fixed Needle CTC RTC & Thermo RSH Syringe with GT Plunger & 5.7 cm 0.72 mm OD LC Tipped Needle		032842
008151	1 mL Removable Needle CTC RTC & Thermo RSH Syringe with GT Plunger & 5.7 cm 0.72 mm OD LC Tipped Needle	039280	032842
008950	10 mL Fixed Needle CTC RTC & Thermo RSH Syringe with GT Plunger & 5.7 cm 1.07 mm OD LC Tipped Needle		032855
008951	10 mL Removable Needle CTC RTC & Thermo RSH Syringe with GT Plunger & 5.7 cm 1.07 mm OD LC Tipped Needle	031590	032855
<b>Hitachi</b>			
007660	500 µL Syringe with GT Plunger and M10 Termination		031837
<b>PerkinElmer</b>			
004995	50 µL Syringe with GT Plunger and 1/4-28 UNF Termination		
005990	100 µL Syringe with GT Plunger and 1/4-28 UNF Termination		
006995	250 µL Syringe with GT Plunger and 1/4-28 UNF Termination		031833
007995	500 µL Syringe with GT Plunger and 1/4-28 UNF Termination		
008185	1 mL Syringe with GT Plunger and 1/4-28 UNF Termination		0318441
008687	2.5 mL Syringe with GT Plunger and 1/4-28 UNF Termination		031854
<b>Spark</b>			
006683	250 µL Spark Syringe with GT Plunger		0318348
<b>Thermospec</b>			
006660	250 µL Thermospec Syringe		
<b>Waters</b>			
003990	25 µL Waters Wisp Syringe with GT Plunger		031819
006690	250 µL Waters Wisp Syringe with GT Plunger		031834

For more information about this product visit [www.sge.com](http://www.sge.com) or contact [techsupport@sge.com](mailto:techsupport@sge.com).

## Syringes | MEPS®

### Extraction to Injection in a Single Process

MEPS® is Micro Extraction by Packed Sorbent, the miniaturization of conventional SPE packed bed devices from milliliter bed volumes to microliter volumes. The MEPS approach to sample preparation is suitable for reversed phases, normal phases, mixed mode or ion exchange chemistries.

The MEPS Barrel Insert and Needle (BIN) assembly contains the stationary phase, and is built into the syringe needle. Using MEPS requires both a suitable syringe and a MEPS BIN.

With MEPS, the sample processing, extraction and injection steps are performed using the same syringe.

#### Features and Benefits

- MEPS syringes are compatible for use with MEPS BINs.
- Save hours in sample preparation.
- Reduce solvent usage and sample volume.

#### Recommended Applications

SPE method development, and/or proofing before transition to fully automated platforms. Processing small sample batches, or urgent samples.

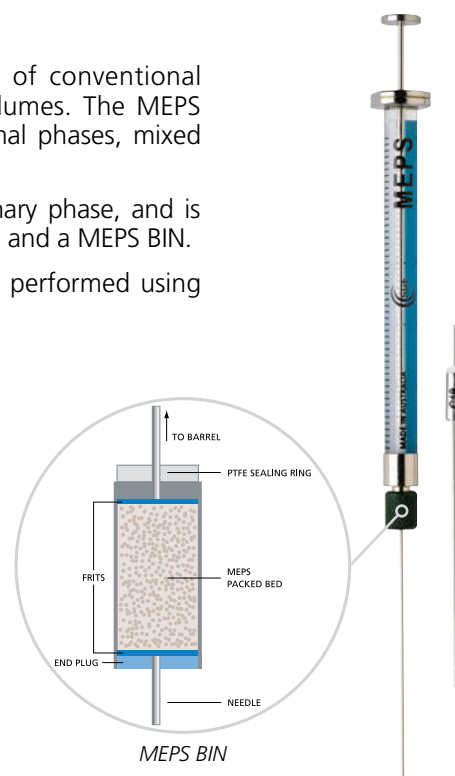

#### Product Specifications

- 100 µL and 250 µL removable needle MEPS syringes available to suit a range of autosamplers or can be used manually.
- MEPS syringes are easily identifiable with MEPS printed on the barrel, and a green removable nut.
- MEPS BINs are available separately.

For more information about this product refer to product data sheet PD-1095-G Separations | MEPS BINs, visit [www.sge.com](http://www.sge.com) or contact [techsupport@sge.com](mailto:techsupport@sge.com).

## Syringes | MEPS®

### Extraction to Injection in a Single Process

Part Number	Part Description and Detail	Replacement Plunger
<b>eVol MEPS Syringes</b>		
2910027	50 µL eVol MEPS Syringe with GT Plunger	2910382
2910028	100 µL eVol MEPS Syringe with GT Plunger	2910383
2910026	500 µL eVol MEPS Syringe with GT Plunger	2910384
<b>Agilent &amp; Shimadzu MEPS Syringes</b>		
005292	100 µL Agilent & Shimadzu MEPS Syringe	0318263
006293	250 µL Agilent & Shimadzu MEPS Syringe	0318303
<b>CTC &amp; Thermo MEPS Syringes</b>		
005291	100 µL CTC & Thermo MEPS Syringe	031826
006292	250 µL CTC MEPS Syringe	0318301
006291	250 µL Thermo MEPS Syringe	031831

For more information about this product visit [www.sge.com](http://www.sge.com) or contact [techsupport@sge.com](mailto:techsupport@sge.com).

## Syringes | Diamond

### Diamond Syringe Range – Syringe Brilliance

The comprehensive range of SGE syringes are designed and tested to meet critical specifications. The Diamond Syringe Range offers a never before seen level of Durability, Clarity and Accuracy in the laboratory.

No other syringe range provides such brilliance.

#### Features and Benefits

- Improved solvent resistance.
- Greater temperature ranges.
- Increased operational smoothness.
- Longer syringe life.
- Reduced carry over, adhesive contamination, and sample interaction.
- Each plunger is individually fitted for each micro syringe for perfect sealing.
- Plunger protection on 5  $\mu$ L and 10  $\mu$ L syringes helps prevent plunger bending during injection.
- Metal back flange with flat sides prevents syringe rolling off benches.
- Bright white backing strip with black scale markings for accurate reading of the syringe scale.
- Metal cap on fixed needle syringes protects the syringe barrel from chipping and breakage.

#### Recommended Applications

Manual GC and LC sample injection. Liquid dispensing.

#### Product Specifications

Accuracy and Reproducibility	$\pm 1\%$ (dispensed volume)
Borosilicate Glass Barrel Outer Diameter (OD)	6.5 mm for 5 - 10 $\mu$ L, 8 mm for guided plunger syringes and 50 - 500 $\mu$ L
Scale Length	54.1 mm for 5 - 10 $\mu$ L, 60 mm for 50 - 500 $\mu$ L
Volume Range	5 $\mu$ L - 500 $\mu$ L
International Standards Traceability	

Option of either SuperfleX™ flexible plunger or guided plungers on 5  $\mu$ L and 10  $\mu$ L syringes. Fixed and removable needle version are available.

For more information about this product visit [www.sge.com](http://www.sge.com) or contact [techsupport@sge.com](mailto:techsupport@sge.com).

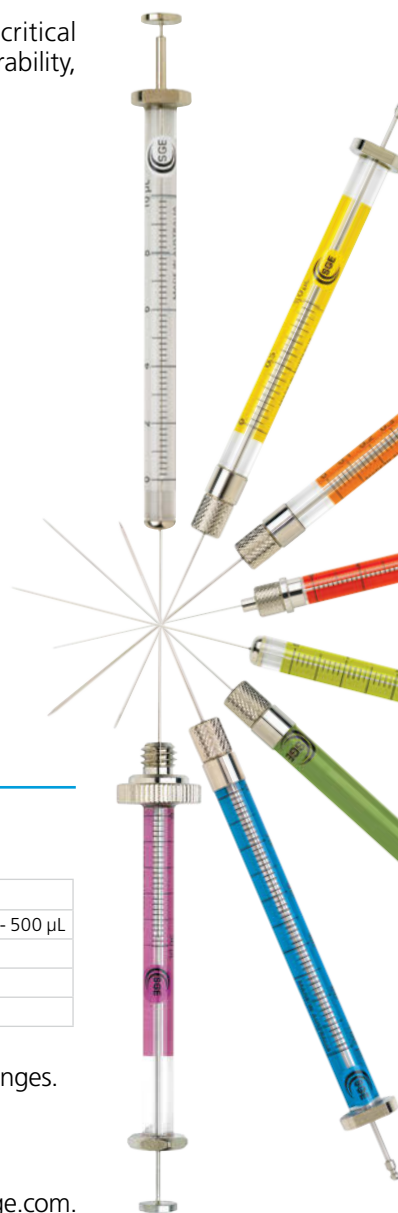

## Syringes | Diamond

### Diamond Syringe Range – Syringe Brilliance

Part Number	Long Description	Replacement Needle
001000	5 µL Fixed Needle Syringe with 5 cm 0.47 mm OD Bevel Tipped Needle	
001050	5 µL Removable Needle Syringe with 5 cm 0.47 mm OD Bevel Tipped Needle	036110
001100	5 µL Fixed Needle Syringe with Flexible Plunger & 5 cm 0.47 mm OD Bevel Tipped Needle	
002000	10 µL Fixed Needle Syringe with 5 cm 0.47 mm OD Bevel Tipped Needle	
002005	10 µL Fixed Needle Syringe with 5 cm 0.47 mm OD Cone Tipped Needle	
002030	10 µL Fixed Needle Syringe with 5 cm 0.47 mm OD Bevel Tipped Needle PK6	
002033	10 µL Fixed Needle Syringe with 5 cm 0.47 mm OD Bevel Tipped Needle PK10	
002035	10 µL Fixed Needle Syringe with 5 cm 0.47 mm OD Bevel Tipped Needle PK25	
002003	10 µL Fixed Needle Syringe with 7 cm 0.47 mm OD Bevel Tipped Needle	
002050	10 µL Removable Needle Syringe with 5 cm 0.47 mm OD Bevel Tipped Needle	037110
002080	10 µL Removable Needle Syringe with 5 cm 0.47 mm OD Bevel Tipped Needle PK6	037110
002100	10 µL Fixed Needle Syringe with Flexible Plunger & 5 cm 0.47 mm OD Bevel Tipped Needle	
002105	10 µL Fixed Needle Syringe with Flexible Plunger & 5 cm 0.47 mm OD Cone Tipped Needle	
002130	10 µL Fixed Needle Syringe with Flexible Plunger & 5 cm 0.47 mm OD Bevel Tipped Needle PK6	
002133	10 µL Fixed Needle Syringe with Flexible Plunger & 5 cm 0.47 mm OD Cone Tipped Needle PK6	
002135	10 µL Fixed Needle Syringe with Flexible Plunger & 5 cm 0.63 mm OD Cone Tipped Needle PK6	
002180	10 µL Removable Needle Syringe with Flexible Plunger & 5 cm 0.47 mm OD Bevel Tipped Needle PK6	037110
003000	25 µL Fixed Needle Syringe with 5 cm 0.5 mm OD Bevel Tipped Needle	
003050	25 µL Removable Needle Syringe with 5 cm 0.5 mm OD Bevel Tipped Needle	038110
004000	50 µL Fixed Needle Syringe with 5 cm 0.5 mm OD Bevel Tipped Needle	
004050	50 µL Removable Needle Syringe with 5 cm 0.5 mm OD Bevel Tipped Needle	038110
005000	100 µL Fixed Needle Syringe with 5 cm 0.5 mm OD Bevel Tipped Needle	
005050	100 µL Removable Needle Syringe with 5 cm 0.5 mm OD Bevel Tipped Needle	038110
005055	100 µL Removable Needle Syringe with 7 cm 0.5 mm OD Bevel Tipped Needle	038130
006000	250 µL Fixed Needle Syringe with 5 cm 0.5 mm OD Bevel Tipped Needle	
006050	250 µL Removable Needle Syringe with 5 cm 0.5 mm OD Bevel Tipped Needle	038110
007000	500 µL Fixed Needle Syringe with 5 cm 0.5 mm OD Bevel Tipped Needle	
007050	500 µL Removable Needle Syringe with 5 cm 0.5 mm OD Bevel Tipped Needle	038110

For more information about this product visit [www.sge.com](http://www.sge.com) or contact [techsupport@sge.com](mailto:techsupport@sge.com).

## Syringes | Diamond Gas Tight

### Diamond Syringe Range – Syringe Brilliance

The comprehensive range of SGE syringes are designed and tested to meet critical specifications. The Diamond Syringe Range offers a never before seen level of Durability, Clarity and Accuracy in the laboratory.

No other syringe range provides such brilliance.

#### Features and Benefits

- PTFE plunger tip for perfect sealing.
- Metal back flange with flat sides prevents syringe rolling off benches.
- Bright white backing strip with black scale markings for accurate reading of the syringe scale.
- Metal cap on fixed needle syringes protects the syringe barrel from chipping and breakage.

#### Recommended Applications

Manual GC and LC sample injection. Liquid dispensing.



#### Product Specifications

Accuracy and Reproducibility	± 1 % (dispensed volume)
Borosilicate Glass Barrel Outer Diameter (OD)	10 µL = 6.5 mm, 25-500 µL = 8 mm, 1 mL = 8.8 mm, 2.5 mL = 10.8 mm, 5 mL = 13.7 mm, 10 mL = 18 mm, 25 mL = 27 mm, 50 mL = 32.6 mm, 100 mL = 40.6 mm
Scale Length	10 µL = 54.1 mm, 25 µL - 25 mL = 60 mm, 50 mL = 81 mm, 100 mL = 114 mm
Volume Range	10 µl - 100 mL
International Standards Traceability	

Fixed and removable needle, luer and luer lock versions are available.

For more information about this product visit [www.sge.com](http://www.sge.com) or contact [techsupport@sge.com](mailto:techsupport@sge.com).

## Syringes | Diamond Gas Tight Diamond Syringe Range – Syringe Brilliance

Part Number	Long Description	Replacement Needle	Replacement Plunger
002200	10 µL Fixed Needle Syringe with GT Plunger & 5 cm 0.47 mm OD Bevel Tipped Needle		031810
002202	10 µL Fixed Needle Syringe with GT Plunger & 5 cm 0.47 mm OD Bevel Tipped Needle PK6		031810
002208	10 µL Fixed Needle Syringe with GT Plunger & 7 cm 0.47 mm OD Bevel Tipped Needle		031810
002250	10 µL Removable Needle Syringe with GT Plunger & 5 cm 0.47 mm OD Bevel Tipped Needle	037110	031811
002252	10 µL Removable Needle Syringe with GT Plunger & 5 cm 0.47 mm OD Bevel Tipped Needle PK6	037110	031811
003200	25 µL Fixed Needle Syringe with GT Plunger & 5 cm 0.5 mm OD Bevel Tipped Needle		031815
003250	25 µL Removable Needle Syringe with GT Plunger & 5 cm 0.5 mm OD Bevel Tipped Needle	038110	031815
004200	50 µL Fixed Needle Syringe with GT Plunger & 5 cm 0.5 mm OD Bevel Tipped Needle		031820
004229	50 µL Fixed Luer Tip Syringe with GT Plunger		031820
004230	50 µL Fixed Luer Lock Syringe with GT Plunger		031820
004232	50 µL Fixed Luer Lock Syringe with GT Plunger & Plunger Stop		0318221
004250	50 µL Removable Needle Syringe with GT Plunger & 5 cm 0.5 mm OD Bevel Tipped Needle	038110	031820
004279	50 µL Syringe with Removable Needle Valve & GT Plunger		031820
005200	100 µL Fixed Needle Syringe with GT Plunger & 5 cm 0.5 mm OD Bevel Tipped Needle		031825
005229	100 µL Fixed Luer Tip Syringe with GT Plunger		031825
005230	100 µL Fixed Luer Lock Syringe with GT Plunger		031825
005232	100 µL Fixed Luer Lock Syringe with GT Plunger & Plunger Stop		0318271
005250	100 µL Removable Needle Syringe with GT Plunger & 5 cm 0.5 mm OD Bevel Tipped Needle	038110	031825
005279	100 µL Syringe with Removable Needle Valve & GT Plunger		031825
006200	250 µL Fixed Needle Syringe with GT Plunger & 5 cm 0.5 mm OD Bevel Tipped Needle		031830
006229	250 µL Fixed Luer Tip Syringe with GT Plunger		031830
006230	250 µL Fixed Luer Lock Syringe with GT Plunger		031830
006232	250 µL Fixed Luer Lock Syringe with GT Plunger & Plunger Stop		031833
006250	250 µL Removable Needle Syringe with GT Plunger & 5 cm 0.5 mm OD Bevel Tipped Needle	038110	031830
006279	250 µL Syringe with Removable Needle Valve & GT Plunger		031830
007200	500 µL Fixed Needle Syringe with GT Plunger & 5 cm 0.5 mm OD Bevel Tipped Needle		031835
007229	500 µL Fixed Luer Tip Syringe with GT Plunger		031835
007230	500 µL Fixed Luer Lock Syringe with GT Plunger		031835
007232	500 µL Fixed Luer Lock Syringe with GT Plunger & Plunger Stop		0318381
007250	500 µL Removable Needle Syringe with GT Plunger & 5 cm 0.5 mm OD Bevel Tipped Needle	038110	031835
007279	500 µL Syringe with Removable Needle Valve & GT Plunger		031835
008020	1 mL Fixed Luer Tip Syringe with GT Plunger		031842
008025	1 mL Fixed Luer Lock Syringe with GT Plunger		031842
008100	1 mL Removable Needle Syringe with GT Plunger & 5 cm 0.63 mm OD Bevel Tipped Needle	039110	031842
008102	1 mL Fixed Needle Syringe with GT Plunger & 5 cm 0.72 mm OD Bevel Tipped Needle		031842
008110	1 mL Syringe with Removable Needle Valve & GT Plunger		031842
008160	1 mL Syringe with Removable Luer Lock Valve & GT Plunger		031842
008420	2.5 mL Fixed Luer Tip Syringe with GT Plunger		031852
008425	2.5 mL Fixed Luer Lock Syringe with GT Plunger		031852
008500	2.5 mL Removable Needle Syringe with GT Plunger & 5 cm 0.63 mm OD Bevel Tipped Needle	039110	031852
008502	2.5 mL Fixed Needle Syringe with GT Plunger & 5 cm 0.72 mm OD Bevel Tipped Needle		031852
008510	2.5 mL Syringe with Removable Needle Valve & GT Plunger		031852
008560	2.5 mL Syringe with Removable Luer Lock Valve & GT Plunger		031852
008700	5 mL Removable Needle Syringe with GT Plunger & 5 cm 0.63 mm OD Bevel Tipped Needle	031516	031856
008760	5 mL Removable Luer Lock Syringe with GT Plunger		031856
008762	5 mL Fixed Luer Lock Syringe with GT Plunger		0318562
008770	5 mL Syringe with Removable Luer Lock Valve & GT Plunger		031856
008900	10 mL Removable Needle Syringe with GT Plunger & 5 cm 0.63 mm OD Bevel Tipped Needle	031516	031862
008960	10 mL Removable Luer Lock Syringe with GT Plunger		031862
008962	10 mL Fixed Luer Lock Syringe with GT Plunger		031864
008970	10 mL Syringe with Removable Luer Lock Valve & GT Plunger		031862
009462	25 mL Removable Luer Lock Syringe with GT Plunger		031870
009463	25 mL Fixed Luer Lock Syringe with GT Plunger		031874
009472	25 mL Syringe with Removable Luer Lock Valve & GT Plunger		031870
009660	50 mL Removable Luer Lock Syringe with GT Plunger		0312170
009670	50 mL Syringe with Removable Luer Lock Valve & GT Plunger		0312170
009760	100 mL Removable Luer Lock Syringe with GT Plunger		0312176
009770	100 mL Syringe with Removable Luer Lock Valve & GT Plunger		0312176

## Syringes | Guided Plunger

### Diamond Syringe - Syringe Brilliance

Guided plunger syringes are the most rugged syringe available, making them perfect for industrial environments.

#### Features and Benefits

- Extended barrel guides plunger during injection.
- Robust and rugged.

#### Recommended Applications

Ideal for student and industrial use.



#### Product Specifications

Available in 5  $\mu$ L to 10  $\mu$ L capacities.

Accuracy and Reproducibility	$\pm 1$ % (displaced volume)
Temperature Range	5-70 °C Fixed Needle, 5-120 °C Removable Needle
International Standards Traceability	

For more information about this product visit [www.sge.com](http://www.sge.com) or contact [techsupport@sge.com](mailto:techsupport@sge.com).



## Syringes | Guided Plunger

### Diamond Syringe - Syringe Brilliance

Part Number	Part Description and Detail	Replacement Needle	Replacement Plunger
001400	5 µL Fixed Needle Guided Plunger Syringe with 5 cm 0.47 mm OD Bevel Tipped Needle		
001450	5 µL Removable Needle Guided Plunger Syringe with 5 cm 0.47 mm OD Bevel Tipped Needle	036110	
001495	5 µL Removable Needle Guided Plunger Syringe with 5 cm 0.47 mm OD Bevel Tipped Needle (Half Scale)	037110	
002400	10 µL Fixed Needle Guided Plunger Syringe with 5 cm 0.47 mm OD Bevel Tipped Needle		
002450	10 µL Removable Needle Guided Plunger Syringe with 5 cm 0.47 mm OD Bevel Tipped Needle	037110	
002455	10 µL Removable Needle Guided Plunger Syringe with GT Plunger & 5 cm 0.47 mm OD Bevel Tipped Needle	037110	031805

For more information about this product visit [www.sge.com](http://www.sge.com) or contact [techsupport@sge.com](mailto:techsupport@sge.com).

## Syringes | Jumbo

For the handling of large volumes of gas, SGE Jumbo syringes offer convenient use as well as versatility and reliability.

### Features and Benefits

Heavy duty acrylic barrels. Easy access to sample for the addition of standards or removal of subsample via secondary port. Plunger stem is removable for ease of transportation and storage.

Compatible with a range of fittings; has a 7/16" UNEF thread and designed to be used with Luer Lock fittings and needles.

### Recommended Applications

Ideal for calibration of medical equipment such as respirators and spirometers, and for stack and air sampling.

Do not subject Jumbo syringes to temperatures in excess of 80 °C.

### Product Specifications

Accuracy and Reproducibility	± 2 % (dispensed volume)
Acrylic Barrel Outer Diameter (OD)	0.5 L = 70 mm, 1 L = 100 mm and 2 L = 130 mm
Scale Length	0.5 L = 179.2 mm, 1 L = 159.1 mm and 2 L = 179 mm
International Standards Traceability	

Syringe Volume	Barrel Length (mm)	Barrel OD (mm)	Major Scale Divisions (mL)	Minor Scale Divisions (mL)
0.5 L	245	70	50	25
1 L	245	100	100	50
2 L	245	130	200	100



For more information about this product visit [www.sge.com](http://www.sge.com) or contact [techsupport@sge.com](mailto:techsupport@sge.com).

## Syringes | Jumbo

Part Number	Part Description and Detail	Replacement Plunger O-Ring
009910	500 mL Jumbo Luer Lock Syringe	032527
009920	1000 mL Jumbo Luer Lock Syringe	032532
009930	2000 mL Jumbo Luer Lock Syringe	032537

For more information about this product visit [www.sge.com](http://www.sge.com) or contact [techsupport@sge.com](mailto:techsupport@sge.com).

## Syringes | For Rheodyne® and Valco® Valves

### Diamond Syringe - Syringe Brilliance

A range of SGE syringes specifically designed for use with Rheodyne® and Valco® injection valves. Syringes use a 22 gauge (0.028" OD), 5.1 cm (2") long needle with a square cut (90 °) needle tip style and no electrotaper. Selection of the syringe capacity will depend on the injection technique.

#### Features and Benefits

- Metal back flange with flat sides prevents syringe rolling off benches.
- Bright white backing strip with black scale markings for accurate reading of the syringe scale.
- Metal cap on fixed needle syringes protects the syringe barrel from chipping and breakage.

#### Recommended Applications

For partial HPLC injection loop fill, the injection volume should be no greater than half the loop capacity. The injection size sets the injection volume.

For complete loop fill, the syringe capacity should be greater than twice the loop volume. A luer lock syringe fitted with a Rheodyne/Valco luer lock needle is ideal for this purpose. The loop capacity sets the injection volume.

#### Product Specifications

Available in 5 µL to 500 µL fixed needle capacities, and 10 µL to 2.5 mL removable needle capacities.

Accuracy and Reproducibility	± 1 % (displaced volume)
Temperature Range	5-70 °C Fixed Needle, 5-120 °C Removable Needle
International Standards Traceability	

For more information about this product visit [www.sge.com](http://www.sge.com) or contact [techsupport@sge.com](mailto:techsupport@sge.com).



*Rheodyne is a registered trademark of Sigma-Aldrich. Valco is a registered trademark of Valco Instruments Co. Inc.*

## Syringes | For Rheodyne® and Valco® Valves

### Diamond Syringe - Syringe Brilliance

Part Number	Part Description and Detail	Replacement Needle	Replacement Plunger
001301	5 µL Fixed Needle Syringe with 5.1 cm 0.72 mm OD LC Needle		
002301	10 µL Fixed Needle Syringe with 5.1 cm 0.72 mm OD LC Needle		
002315	10 µL Fixed Needle Syringe with 5.1 cm 0.72 mm OD LC Needle PK6		
002300	10 µL Fixed Needle Syringe with SuperFlex Plunger & 5.1 cm 0.72 mm OD LC Needle		
002330	10 µL Fixed Needle Syringe with SuperFlex Plunger & 5.1 cm 0.72 mm OD LC Needle PK6		
002335	10 µL Fixed Needle Syringe with GT Plunger & 5.1 cm 0.72 mm OD LC Needle		031801
002313	10 µL Removable Needle Syringe with GT Plunger & 5.1 cm 0.72 mm OD LC Needle	037250	031811
003300	25 µL Fixed Needle Syringe with 5.1 cm 0.72 mm OD LC Needle		
003312	25 µL Removable Needle Syringe with GT Plunger & 5.1 cm 0.72 mm OD LC Needle	038250	031815
004300	50 µL Fixed Needle Syringe with 5.1 cm 0.72 mm OD LC Needle		
004312	50 µL Removable Needle Syringe with GT Plunger & 5.1 cm 0.72 mm OD LC Needle	038250	031820
005300	100 µL Fixed Needle Syringe with 5.1 cm 0.72 mm OD LC Needle		
005312	100 µL Removable Needle Syringe with GT Plunger & 5.1 cm 0.72 mm OD LC Needle	038250	031825
006300	250 µL Fixed Needle Syringe with 5.1 cm 0.72 mm OD LC Needle		
006310	250 µL Removable Needle Syringe with 5.1 cm 0.72 mm OD LC Needle	038250	
006312	250 µL Removable Needle Syringe with GT Plunger & 5.1 cm 0.72 mm OD LC Needle	038250	031830
007300	500 µL Fixed Needle Syringe with & 5.1 cm 0.72 mm OD LC Needle		
007310	500 µL Removable Needle Syringe with 5.1 cm 0.72 mm OD LC Needle	038250	
007312	500 µL Removable Needle Syringe with GT Plunger & 5.1 cm 0.72 mm OD LC Needle	038250	031835
008105	1 mL Removable Needle Syringe with GT Plunger & 5.1 cm 0.72 mm OD LC Needle	039250	031842
008505	2.5 mL Removable Needle Syringe with GT Plunger & 5.1 cm 0.72 mm OD LC Needle	039250	031852

For more information about this product visit [www.sge.com](http://www.sge.com) or contact [techsupport@sge.com](mailto:techsupport@sge.com).

## Syringes | NanoVolume

With the ability to inject down to 50 nL with high precision and accuracy, SGE NanoVolume Syringes are perfect for NanoVolume capillary chromatography injection as well as making accurate standards that require small volumes. The sample is only drawn into the needle, not the syringe barrel. When the plunger is depressed, the sample is completely dispensed by the NanoVolume plunger that extends to the tip of the needle.

### Features and Benefits

- Plunger extends into the needle tip.
- Sample is contained only in the needle, i.e. no glass contact.
- Ideal for dispensing very small liquid volumes. Virtually zero dead volume and carry over between injections.

### Recommended Applications

Recommended for use when sample volume is less than 1000 nL (1  $\mu$ L).

### Product Specifications

Available in 500 nL (0.5  $\mu$ L), 1000 nL (1  $\mu$ L) and 5000 nL (5  $\mu$ L).

Accuracy and Reproducibility	$\pm 2$ % (dispensed volume)
Temperature Range	5-70 $^{\circ}$ C
International Standards Traceability	

For more information about this product visit [www.sge.com](http://www.sge.com) or contact [techsupport@sge.com](mailto:techsupport@sge.com).

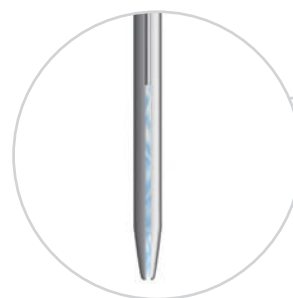

## Syringes | NanoVolume

Part Number	Part Description and Detail	Replacement Needle and Plunger Kit
<b>Manual</b>		
000303	0.5 µL NanoVolume Syringe with 5 cm 0.47 mm OD Cone Tipped Needle	033012
000353	0.5 µL NanoVolume Syringe with 5 cm 0.47 mm OD Cone Tipped Needle & Repeating Adaptor	033012
000301	0.5 µL NanoVolume Syringe with 5 cm 0.63 mm OD Bevel Tipped Needle	033011
000300	0.5 µL NanoVolume Syringe with 5 cm 0.63 mm OD Cone Tipped Needle	033010
000350	0.5 µL NanoVolume Syringe with 5 cm 0.63 mm OD Cone Tipped Needle & Repeating Adaptor	033010
000311	0.5 µL NanoVolume Syringe with 7 cm 0.63 mm OD Bevel Tipped Needle	033060
000310	0.5 µL NanoVolume Syringe with 7 cm 0.63 mm OD Cone Tipped Needle	033057
000355	0.5 µL NanoVolume Syringe with 7 cm 0.63 mm OD Cone Tipped Needle & Repeating Adaptor	033057
000376	0.5 µL NanoVolume On-Column Syringe with 7 cm 0.47 mm OD Needle	033630
000380	0.5 µL NanoVolume On-Column Syringe with 7.5 cm 0.23 mm OD Needle	033620
000501	1.0 µL NanoVolume Syringe with 5 cm 0.63 mm OD Bevel Tipped Needle	034056
000500	1.0 µL NanoVolume Syringe with 5 cm 0.63 mm OD Cone Tipped Needle	034055
000550	1.0 µL NanoVolume Syringe with 5 cm 0.63 mm OD Cone Tipped Needle & Repeating Adaptor	034055
000570	1.0 µL NanoVolume Syringe with 7 cm 0.47 mm OD Cone Tipped Needle	034610
000506	1.0 µL NanoVolume Syringe with 7 cm 0.63 mm OD Bevel Tipped Needle	034060
000505	1.0 µL NanoVolume Syringe with 7 cm 0.63 mm OD Cone Tipped Needle	034057
000553	1.0 µL NanoVolume Syringe with 7 cm 0.63 mm OD Cone Tipped Needle & Repeating Adaptor	034057
000510	1.0 µL NanoVolume Syringe with 11.5 cm 0.63 mm OD Bevel Tipped Needle	034059
000800	5.0 µL NanoVolume Syringe with 5 cm 0.63 mm OD Cone Tipped Needle	035055
000801	5.0 µL NanoVolume Syringe with 5 cm 0.63 mm OD Bevel Tipped Needle	035056
000850	5.0 µL NanoVolume Syringe with 5 cm 0.63 mm OD Cone Tipped Needle & Repeating Adaptor	035055
000803	5.0 µL NanoVolume Syringe with 7 cm 0.63 mm OD Bevel Tipped Needle	035058
000802	5.0 µL NanoVolume Syringe with 7 cm 0.63 mm OD Cone Tipped Needle	035057
000852	5.0 µL NanoVolume Syringe with 7 cm 0.63 mm OD Cone Tipped Needle & Repeating Adaptor	035057
000805	5.0 µL NanoVolume Syringe with 7 cm 0.63 mm OD Nozzle Tipped Needle	035060
000804	5.0 µL NanoVolume Syringe with 11.5 cm 0.63 mm OD Cone Tipped Needle	035059
<b>Agilent</b>		
000400	0.5 µL NanoVolume Agilent Syringe with 4.2 cm 0.47 mm OD Cone Tipped Needle	033708
000410	0.5 µL NanoVolume Agilent Syringe with 4.2 cm 0.63 mm OD Cone Tipped Needle	033715
000415	0.5 µL NanoVolume Agilent Syringe with 4.2 cm 0.63/0.47 mm OD Dual Gauge Cone Tipped Needle	033730
000610	1.0 µL NanoVolume Agilent Syringe with 4.2 cm 0.63 mm OD Cone Tipped Needle	034715
<b>CTC/Thermo</b>		
000490	0.5 µL NanoVolume CTC/Thermo Syringe with 5 cm 0.47 mm OD Cone Tipped Needle	033770
000492	0.5 µL NanoVolume CTC/Thermo Syringe with 5 cm 0.63 mm OD Cone Tipped Needle	033772
000480	0.5 µL NanoVolume CTC RTC & Thermo RSH Syringe with 5.7 cm 0.63 mm OD Cone Tipped Needle	033780
000680	1.0 µL NanoVolume CTC RTC & Thermo RSH Syringe with 5.7 cm 0.63 mm OD Cone Tipped Needle	034780
000790	2.0 µL NanoVolume CTC/Thermo Syringe with 5.0 cm 0.63 mm OD Cone Tipped Needle	034905
<b>Shimadzu</b>		
000440	0.5 µL NanoVolume Shimadzu Syringe with 4.2 cm 0.47 mm OD Cone Tipped Needle	033738
000445	0.5 µL NanoVolume Shimadzu Syringe with 4.2 cm 0.63 mm OD Cone Tipped Needle	033745
<b>PerkinElmer</b>		
000475	0.5 µL NanoVolume PerkinElmer Syringe with 7 cm 0.47 mm OD Cone Tipped Needle	033750
000478	0.5 µL NanoVolume PerkinElmer Syringe with 7 cm 0.63 mm OD Cone Tipped Needle	033765
<b>Varian</b>		
000655	1.0 µL NanoVolume Varian (8035, 8100, 8200) Syringe with 5.1 cm 0.47 mm OD Cone Tipped Needle	034720

For more information about this product visit [www.sge.com](http://www.sge.com) or contact [techsupport@sge.com](mailto:techsupport@sge.com).

## Syringes | For Hamilton C and CX

### The Choice for Dispenser and Pump Syringes

SGE Dispenser and Pump Syringes incorporate Diamond Technology, taking advantage of new and innovative technologies and bringing those benefits to your laboratory.

For over 50 years, SGE syringes have been designed and manufactured for a variety of instruments and customer applications.

At the heart of your pump or dispenser, and combined with the rest of the system components, syringes must provide the superior performance you demand and rely upon.

Designed and optimized with outstanding quality and precise fit, SGE syringes provide greater reliability for applications run on your systems.

#### Features and Benefits

- Improved accuracy and precision.
- Robust and durable for longer life, less maintenance downtime and reduced maintenance costs.
- Do not contaminate the aspirated fluid
- Designed to perfectly fit your instrument making them easy to use and install.

#### Recommended Applications

Replacement for Hamilton C and CX Syringes.

#### Product Specifications

- 60 mm stroke.
- 1/4-28 UNF thread connection.
- 6-32 UNC thread in plunger button. CX has a button stop.
- 25 µL to 10 mL capacities.
- Operating temperature range (10 °C to 40 °C).

Volume	Front Fitting Diameter (mm)	Back Fitting Diameter (mm)	Glass Barrel Diameter (mm)	Plunger Button Diameter (mm)	Orifice (mm)
25 µL	9.9	14.2	8	12.7	1.0
50 µL	9.9	14.2	8	12.7	1.0
100 µL	9.9	14.2	8	12.7	1.0
250 µL	9.9	14.2	8	12.7	1.0
500 µL	9.9	14.2	8	12.7	1.0
1 mL	10.4	14.2	9	12.6	1.5
2.5 mL	12.0	15.6	11	11.9	1.5
5 mL	15.0	23.1	14	11.9	1.5
10 mL	20	28.0	18.5	14	1.5



For more information about this product visit [www.sge.com](http://www.sge.com) or contact [techsupport@sge.com](mailto:techsupport@sge.com).



## Syringes | For Hamilton C and CX

### The Choice for Dispenser and Pump Syringes

Part Number	Long Description	Replacement Plunger
004995	50 µL Syringe with GT Plunger and 1/4-28 UNF Termination	
005990	100 µL Syringe with GT Plunger and 1/4-28 UNF Termination	
006995	250 µL Syringe with GT Plunger and 1/4-28 UNF Termination	031833
007995	500 µL Syringe with GT Plunger and 1/4-28 UNF Termination	
008185	1 mL Syringe with GT Plunger and 1/4-28 UNF Termination	0318441
008687	2.5 mL Syringe with GT Plunger and 1/4-28 UNF Termination	031854
008787	5 mL Syringe with GT Plunger and 1/4-28 UNF Termination	0318562
008987	10 mL Syringe with GT Plunger and 1/4-28 UNF Termination	031864

For more information about this product visit [www.sge.com](http://www.sge.com) or contact [techsupport@sge.com](mailto:techsupport@sge.com).

## Syringes | For PSD/3 and PSD/4 Pumps

### The Choice for Dispenser and Pump Syringes

SGE Dispenser and Pump Syringes incorporate Diamond Technology, taking advantage of new and innovative technologies and bringing those benefits to your laboratory.

For over 50 years, SGE syringes have been designed and manufactured for a variety of instruments and customer applications.

At the heart of your pump or dispenser, and combined with the rest of the system components, syringes must provide the superior performance you demand and rely upon.

Designed and optimized with outstanding quality and precise fit, SGE syringes provide greater reliability for applications run on your systems.

#### Features and Benefits

- Improved accuracy and precision.
- Robust and durable for longer life, less maintenance downtime and reduced maintenance costs.
- Do not contaminate the aspirated fluid.
- Designed to perfectly fit your instrument making them easy to use and install.
- Broad functional temperature range and high chemical resistance.
- Reduced downtime due to leakage.
- Inert flow path. Only high quality borosilicate glass and premium PTFE contact aspirated fluid.

#### Recommended Applications

For use with PSD/3 and PSD/4 pumps.



#### Product Specifications

- 30 mm stroke.
- Luer Lock connection.
- 12.5  $\mu$ L to 12.5 mL capacities.
- Operating temperature range (10  $^{\circ}$ C to 40  $^{\circ}$ C)

Volume	Front Fitting Diameter (mm)	Plunger Button Diameter (mm)	Orifice (mm)
12.5 $\mu$ L	9.7	12.6	0.52
25 $\mu$ L	9.7	12.6	0.6
50 $\mu$ L	9.7	12.6	0.6
125 $\mu$ L	9.7	12.6	1.0
100 $\mu$ L	9.7	12.6	0.6
250 $\mu$ L	9.7	12.6	1.2
500 $\mu$ L	10.1	12.6	1.4
1.25 mL	12.2	12.6	1.8
1 mL	10.8	12.6	1.6
2.5 mL	14.9	14.5	1.8
5 mL	19.8	14.5	1.8
12.5 mL	29	14.5	1.8

For more information about this product visit [www.sge.com](http://www.sge.com) or contact [techsupport@sge.com](mailto:techsupport@sge.com).

## Syringes | For PSD/3 and PSD/4 Pumps

### The Choice for Dispenser and Pump Syringes

Part Number	Part Description and Detail
002692	12.5 µL PSD/3 & PSD/4 Dispenser Syringe
003694	25 µL PSD/3 & PSD/4 Dispenser Syringe
004694	50 µL PSD/3 & PSD/4 Dispenser Syringe
005694	100 µL PSD/3 & PSD/4 Dispenser Syringe
005692	125 µL PSD/3 & PSD/4 Dispenser Syringe
006694	250 µL PSD/3 & PSD/4 Dispenser Syringe
007694	500 µL PSD/3 & PSD/4 Dispenser Syringe
008194	1.0 mL PSD/3 & PSD/4 Dispenser Syringe
008192	1.25 mL PSD/3 & PSD/4 Dispenser Syringe
008594	2.5 mL PSD/3 & PSD/4 Dispenser Syringe
008794	5.0 mL PSD/3 & PSD/4 Dispenser Syringe
008994	12.5 mL PSD/3 & PSD/4 Dispenser Syringe

For more information about this product visit [www.sge.com](http://www.sge.com) or contact [techsupport@sge.com](mailto:techsupport@sge.com).

## Syringes | For V3 Pumps

### The Choice for Dispenser and Pump Syringes

SGE Dispenser and Pump Syringes incorporate Diamond Technology, taking advantage of new and innovative technologies and bringing those benefits to your laboratory.

For over 50 years, SGE syringes have been designed and manufactured for a variety of instruments and customer applications.

At the heart of your pump or dispenser, and combined with the rest of the system components, syringes must provide the superior performance you demand and rely upon.

Designed and optimized with outstanding quality and precise fit, SGE syringes provide greater reliability for applications run on your systems.

#### Features and Benefits

- Improve the accuracy and precision of your results.
- Robust and durable for longer life, less maintenance downtime and reduced maintenance costs.
- Do not contaminate the aspirated fluid.
- Are designed to perfectly fit your instrument making them easy to use and install.
- Increase flexibility with a broad functional temperature range and high chemical resistance.
- Reduce downtime due to leakage.
- Have an inert flow path. Only high quality borosilicate glass and premium PTFE contact aspirated fluid.

#### Recommended Applications

For use with V3 pumps.



#### Product Specifications

- 30 mm stroke.
- 1/4-28 UNF thread connection.
- 1/4" hole in plunger.
- 50 µL to 5.0 mL capacities.

Volume	Front Fitting Diameter (mm)	Orifice (mm)
50 µL	10.1	0.6
100 µL	10.1	0.6
250 µL	10.1	1.2
500 µL	10.1	1.5
1 mL	10.8	1.7
2.5 mL	14.5	1.9
5 mL	19.8	1.9

For more information about this product visit [www.sge.com](http://www.sge.com) or contact [techsupport@sge.com](mailto:techsupport@sge.com).

## Syringes | For V3 Pumps

### The Choice for Dispenser and Pump Syringes

Part Number	Part Description and Detail
004693	50 µL V3 Dispenser Syringe
005693	100 µL V3 Dispenser Syringe
006693	250 µL V3 Dispenser Syringe
007693	500 µL V3 Dispenser Syringe
008193	1.0 mL V3 Dispenser Syringe
008593	2.5 mL V3 Dispenser Syringe
008793	5.0 mL V3 Dispenser Syringe

For more information about this product visit [www.sge.com](http://www.sge.com) or contact [techsupport@sge.com](mailto:techsupport@sge.com).

## Syringes | For V6 Pumps

### The Choice for Dispenser and Pump Syringes

SGE Dispenser and Pump Syringes incorporate Diamond Technology, taking advantage of new and innovative technologies and bringing those benefits to your laboratory.

For over 50 years, SGE syringes have been designed and manufactured for a variety of instruments and customer applications.

At the heart of your pump or dispenser, and combined with the rest of the system components, syringes must provide the superior performance you demand and rely upon.

Designed and optimized with outstanding quality and precise fit, SGE syringes provide greater reliability for applications run on your systems.

#### Features and Benefits

- Improve the accuracy and precision of your results.
- Robust and durable for longer life, less maintenance downtime and reduced maintenance costs.
- Do not contaminate the aspirated fluid.
- Are designed to perfectly fit your instrument making them easy to use and install.
- Increase flexibility with a broad functional temperature range and high chemical resistance.
- Reduce downtime due to leakage.
- Have an inert flow path. Only high quality borosilicate glass and premium PTFE contact aspirated fluid.

#### Recommended Applications

For use with V6 pumps.

#### Product Specifications

- 60 mm stroke.
- 1/4-28 UNF thread connection.
- 1/4" hole in plunger.
- 25  $\mu$ L to 25 mL capacities.
- Operating temperature range (10 °C to 40 °C).

Volume	Front Fitting Diameter (mm)	Orifice (mm)
25 $\mu$ L	10.1	0.7
50 $\mu$ L	10.1	0.6
100 $\mu$ L	10.1	0.6
250 $\mu$ L	10.1	1.0
500 $\mu$ L	10.1	1.2
1 mL	10.1	1.5
2.5 mL	12.2	1.9
5 mL	14.5	1.9
10 mL	19.8	1.9
25 mL	29.0	1.9



For more information about this product visit [www.sge.com](http://www.sge.com) or contact [techsupport@sge.com](mailto:techsupport@sge.com).

## Syringes | For V6 Pumps

### The Choice for Dispenser and Pump Syringes

Part Number	Part Description and Detail
003696	25 µL V6 Dispenser Syringe
004696	50 µL V6 Dispenser Syringe
005696	100 µL V6 Dispenser Syringe
006696	250 µL V6 Dispenser Syringe
007696	500 µL V6 Dispenser Syringe
008196	1.0 mL V6 Dispenser Syringe
008596	2.5 mL V6 Dispenser Syringe
008796	5.0 mL V6 Dispenser Syringe
008996	10 mL V6 Dispenser Syringe
009496	25 mL V6 Dispenser Syringe

For more information about this product visit [www.sge.com](http://www.sge.com) or contact [techsupport@sge.com](mailto:techsupport@sge.com).

## Syringes | eVol® XR

### Every One an Expert

eVol® XR digital analytical syringe is the coupling of two precision devices: a digitally controlled electronic drive and an XCHANGE® enabled analytical syringe.

eVol XR syringes are easily and quickly changed allowing them to be dedicated to individual liquids or methods to prevent possible cross-contamination of reagents.

### Features and Benefits

- Syringes compatible for use with eVol XR.
- Suitable for use with volatile samples.
- Variable speed of operation.
- Easily calibrated and calibration factors saved for each syringe, enabling laboratories to comply with stringent global laboratory standards (e.g. GLP, GMP, FDA).
- Programmable and able to store a laboratory workflow (up to 98 steps).
- Password protection options enabling standardization of work processes.
- Reduces the need for serial dilutions.

### Recommended Applications

- Preparation and addition of standards.
- Precise dispensing of aqueous and non-aqueous liquids.
- TLC spotting.
- Micro titrations.
- GC and LC instrument injections.
- NMR sample preparation.
- MEPS®



### Product Specifications

Available are:

- 5 µL eVol XR syringes available with 50 mm and 115 mm long needles.
- 50 µL eVol XR syringes available with 50 mm, 115 mm, and 180 mm long needles.
- 100 µL eVol XR syringes available with a 50 mm long needle.
- 500 µL eVol XR syringes available with 50 mm, 70 mm, 115 mm, and 180 mm long needles.
- 1 mL eVol XR syringes available with 50 mm, and 70 mm long needles.
- 50 µL, 100 µL and 500 µL removable needle eVol XR MEPS syringes available to fit MEPS BINS.

#### Volume Range of eVol XR Syringes

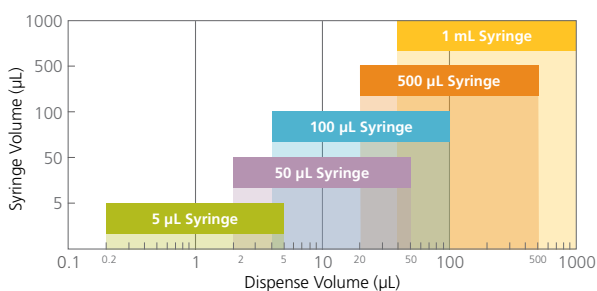

#### Accuracy and Precision

Volume	Inaccuracy	Precision
5 µL	± 0.2 % for calibrated syringe at full scale ± 1.0 % for calibrated syringe at 10 % scale ± 1.0 % for uncalibrated syringe at full scale	0.5 % RSD at full scale 1.0 % RSD at 10 % scale
50 µL	± 0.2 % for calibrated syringe at full scale ± 0.5 % for calibrated syringe at 10 % scale ± 1.0 % for uncalibrated syringe at full scale	0.4 % RSD at full scale 0.8 % RSD at 10 % scale
100 µL	± 0.2 % for calibrated syringe at full scale ± 0.5 % for calibrated syringe at 10 % scale ± 0.7 % for uncalibrated syringe at full scale	0.4 % RSD at full scale 0.7 % RSD at 10 % scale
500 µL	± 0.2 % for calibrated syringe at full scale ± 0.5 % for calibrated syringe at 10 % scale ± 0.5 % for uncalibrated syringe at full scale	0.3 % RSD at full scale 0.6 % RSD at 10 % scale
1 mL	± 0.2 % for calibrated syringe at full scale ± 0.5 % for calibrated syringe at 10 % scale ± 0.5 % for uncalibrated syringe at full scale	0.3 % RSD at full scale 0.6 % RSD at 10 % scale

Specifications are subject to change without notification.

For more information about this product refer to product data sheets PD-1013-G Syringes | eVol XR Kits and PD-1016-G Separations | eVol MEPS BINs, visit [www.sge.com](http://www.sge.com) or contact [techsupport@sge.com](mailto:techsupport@sge.com).



## Syringes | eVol® XR

Every One an Expert

Part Number	Long Description	Replacement Needle	Replacement Plunger
<b>eVol Syringes</b>			
2910020	5 µL eVol Syringe with GT Plunger & 5 cm 0.5 mm OD Bevel Tipped Needle	036910	2910380
2910320	5 µL eVol Syringe with GT Plunger & 5 cm 0.5 mm OD Bevel Tipped Needle PK3	036910	2910380
2910021	5 µL eVol Syringe with GT Plunger. No Needle.		2910380
2910022	50 µL eVol Syringe with GT Plunger & 5 cm 0.5 mm OD Bevel Tipped Needle	038110	2910382
2910322	50 µL eVol Syringe with GT Plunger & 5 cm 0.5 mm OD Bevel Tipped Needle PK3	038110	2910382
2910023	50 µL eVol Syringe with GT Plunger. No Needle.		2910382
2910029	100 µL eVol Syringe with GT Plunger & 5 cm 0.5 mm OD Bevel Tipped Needle	038110	2910383
2910329	100 µL eVol Syringe with GT Plunger & 5 cm 0.5 mm OD Bevel Tipped Needle PK3	038110	2910383
2910037	100 µL eVol Syringe with GT Plunger. No Needle.		2910383
2910024	500 µL eVol Syringe with GT Plunger & 5 cm 0.63 mm OD Bevel Tipped Needle	039110	2910384
2910324	500 µL eVol Syringe with GT Plunger & 5 cm 0.5 mm OD Bevel Tipped Needle PK3	039110	2910384
2910025	500 µL eVol Syringe with GT Plunger. No Needle.		2910384
2910035	1 mL eVol Syringe with GT Plunger & 5 cm 0.63 mm OD Bevel Tipped Needle	039110	2910385
2910335	1 mL eVol Syringe with GT Plunger & 5 cm 0.63 mm OD Bevel Tipped Needle PK3	039110	2910385
<b>eVol MEPS Syringes</b>			
2910027	50 µL eVol MEPS Syringe with GT Plunger		2910382
2910028	100 µL eVol MEPS Syringe with GT Plunger		2910383
2910026	500 µL eVol MEPS Syringe with GT Plunger		2910384
<b>eVol Kits and Components</b>			
2910200	eVol XR Starter Kit (eVol XR Handle, Charger, Stand. 3 eVol Syringes with 5 cm Bevel Tipped Needles: 5 µL , 100 µL , 1 mL )		
2910100	eVol XR Starter Kit for NMR (eVol XR Handle, Charger, Stand. 3 eVol Syringes with Bevel Tipped Needles: 5 µL with 11.5 cm Needle, 50 µL with 11.5 cm and 18 cm Needles, 500 µL with 11.5 cm and 18 cm Needles)		
2910205	eVol XR (Handle Only)		
2910010	eVol Stand (Acrylic)		
2910012	eVol Charger		
2910030	eVol Charging Stand		
2910040	eVol Replacement Battery		

For more information about this product visit [www.sge.com](http://www.sge.com) or contact [techsupport@sge.com](mailto:techsupport@sge.com).

## Syringes | eVol® XR Kits

Every One an Expert

eVol® XR digital analytical syringe is the coupling of two precision devices: a digitally controlled electronic drive and an XCHANGE® enabled analytical syringe.

eVol XR syringes are easily and quickly changed allowing them to be dedicated to individual liquids or methods to prevent possible cross-contamination of reagents.

### Features and Benefits

- Suitable for use with volatile samples.
- Variable speed of operation.
- Easily calibrated and calibration factors saved for each syringe, enabling laboratories to comply with stringent global laboratory standards (e.g. GLP, GMP, FDA).
- Programmable and able to store a laboratory workflow (up to 98 steps).
- Password protection options enabling standardization of work processes.
- Reduces the need for serial dilutions.

### Recommended Applications

- Preparation and addition of standards.
- Precise dispensing of aqueous and non-aqueous liquids.
- TLC spotting.
- Micro titrations.
- GC and LC instrument injections.
- NMR sample preparation.
- MEPS®



### Product Specifications



#### eVol XR Starter Kit

Kit includes:

- Handle.
- Charger.
- Stand.
- 3 eVol XR syringes with 5 cm bevel tipped needles: 5 µL, 100 µL and 1 mL.



#### eVol XR Starter Kit for NMR

Kit includes:

- Handle.
- Charger.
- Stand.
- 3 eVol XR syringes with bevel tipped needles: 5 µL with 11.5 cm needle, 50 µL with 11.5 cm and 18 cm needles, and 500 µL with 11.5 cm and 18 cm needles.

For more information about this product visit [www.sge.com](http://www.sge.com) or contact [techsupport@sge.com](mailto:techsupport@sge.com).

## Syringes | eVol® XR Kits

Every One an Expert







Part Number	Part Description and Detail
2910200	eVol XR Starter Kit (eVol XR Handle, Charger, Stand. 3 eVol Syringes with 5 cm Bevel Tipped Needles: 5 µL , 100 µL , 1 mL )
2910100	eVol XR Starter Kit for NMR (eVol XR Handle, Charger, Stand. 3 eVol Syringes with Bevel Tipped Needles: 5 µL with 11.5 cm Needle, 50 µL with 11.5 cm and 18 cm Needles, 500 µL with 11.5 cm and 18 cm Needles)

For more information about this product visit [www.sge.com](http://www.sge.com) or contact [techsupport@sge.com](mailto:techsupport@sge.com).

## Syringes | Replacement Needles

Wide range of needles available to suit SGE 5  $\mu$ L, 10  $\mu$ L, 25-500  $\mu$ L, 1-2.5 mL, 5-10 mL, luer lock and NanoVolume syringes.

### Recommended Applications

Needle Tip Style	Application	Specifications
 Bevel	Manual GC	The standard general purpose needle tip style supplied with many SGE syringes is a 20 ° bevel tip. It is the preferred option for manual injection where piercing the septum in exactly the same place is difficult. The bevel tip is designed for optimum septum penetration and prevention of septum coring. Bevel tip needles are also known as point style 2.
 Cone	GC Autosampler	The cone shaped needle tip is specially developed to withstand multi injection demands and improve septum lifetime when used with an autosampler. The cone design effectively “parts” the septum during piercing instead of cutting it, as would a bevel needle. Cone tip needles are also known as point style AS for autosampler.
 Dual Gauge	On Column Injection - Autosampler	Dual gauge needles have a narrow gauge at the tip suitable for megabore on-column injection. The wider gauge for the remainder of the needle gives increased strength to the needle for autosampler use.
 LC	HPLC	These needles are used for LC and HPLC valve injection and have a 90 ° square tip with rounded and polished edges. This eliminates damage to the valve's rotor seal and stator face. LC/ HPLC tips are also known as point style 3. This needle tip style is a good choice for general liquid dispensing.
 Dome	With Pre-drilled Septa	This style needle is recommended for use with pre-drilled septa. The tip is rounded and polished to help septum penetration.
 Side Hole	LV Injection	Samples are filled and dispensed through the side hole eliminating septum plugging of the needle. Ideal for large volume gas injection. The solid domed tip minimizes septum damage. Side hole/dome tips are also known as point style 5.
 Sheathed/Bevel	Manual GC	This needle tip style is the same as the bevel tip, except a 0.7 mm OD reinforcing sheath is silver soldered over the standard needle to within 10 mm of the tip. The sheath provides exceptional strength to the needle. Sheathed/Bevel needles are also known as point style 4.

### Product Specifications

Stainless steel, available in various lengths and OD configurations.

For more information about this product visit [www.sge.com](http://www.sge.com) or contact [techsupport@sge.com](mailto:techsupport@sge.com).

## Syringes | Replacement Needles

Part Number	Part Description and Detail
<b>Needles for 5 µL Syringes</b>	
<b>Bevel Tipped</b>	
036110	5 cm 0.47 mm OD Bevel Tipped Needle for 5 µL Syringes PK5
036910	5 cm 0.50 mm OD Bevel Tipped Needle for 5 µL eVol Syringes PK5
036916	7 cm 0.50 mm OD Bevel Tipped Needle for 5 µL eVol Syringes PK5
036920	11.5 cm 0.50 mm OD Bevel Tipped Needle for 5 µL eVol Syringes PK2
<b>Cone Tipped</b>	
036710	4.2 cm 0.47 mm OD Cone Tipped Needle for 5 µL Agilent Syringes PK2
036720	4.2 cm 0.63 mm OD Cone Tipped Needle for 5 µL Agilent Syringes PK2
036011	5 cm 0.63 mm OD Cone Tipped Needle for 5 µL Syringes PK2
036914	5 cm 0.63 mm OD Cone Tipped Needle for 5 µL eVol Syringes PK5
036875	5.7 cm 0.47 mm OD Cone Tipped Needle for 5 µL CTC RTC & Thermo RSH Syringes PK2
036871	5.7 cm 0.63 mm OD Cone Tipped Needle for 5 µL CTC RTC & Thermo RSH Syringes PK2
036918	7 cm 0.47 mm OD Cone Tipped Needle for 5 µL eVol Syringes PK5
036877	8.5 cm 0.47 mm OD Cone Tipped Needle for 5 µL CTC RTC & Thermo RSH Syringes PK2
036873	8.5 cm 0.63 mm OD Cone Tipped Needle for 5 µL CTC RTC & Thermo RSH Syringes PK2
036922	11.5 cm 0.50 mm OD Cone Tipped Needle for 5 µL eVol Syringes PK2
<b>LC Tipped</b>	
036912	5.1 cm 0.72 mm OD LC Tipped Needle for 5 µL eVol Syringes PK5
036920	11.5 cm 0.50 mm OD Bevel Tipped Needle for 5 µL eVol Syringes PK2
<b>Needles for 10 µL Syringes</b>	
<b>Bevel Tipped</b>	
037110	5 cm 0.47 mm OD Bevel Tipped Needle for 10 µL Syringes PK5
037776	5 cm 0.50 mm OD Bevel Tipped Needle for 10 µL Varian 8200 series Syringes PK2
037111	5 cm 0.63 mm OD Bevel Tipped Needle for 10 µL Syringes PK5
037130	7 cm 0.47 mm OD Bevel Tipped Needle for 10 µL Syringes PK5
037788	8 cm 0.47 mm OD Bevel Tipped Needle for 10 µL CTC/Thermo Syringes PK3
037160	11.5 cm 0.47 mm OD Bevel Tipped Needle for 10 µL Syringes PK5
<b>Cone Tipped</b>	
037715	4.2 cm 0.47 mm OD Cone Tipped Needle for 10 µL Agilent Syringes PK2
037745	4.2 cm 0.47 mm OD Cone Tipped Needle for 10 µL Shimadzu Syringes PK2
037730	4.2 cm 0.47/0.63 mm OD Dual Gauge Cone Tipped Needle for 10 µL Agilent Syringes PK2
037717	4.2 cm 0.63 mm OD Cone Tipped Needle for 10 µL Agilent Syringes PK2
037747	4.2 cm 0.63 mm OD Cone Tipped Needle for 10 µL Shimadzu Syringes PK2
037010	5 cm 0.47 mm OD Cone Tipped Needle for 10 µL Syringes PK2
037011	5 cm 0.63 mm OD Cone Tipped Needle for 10 µL Syringes PK2
037787	5 cm 0.63 mm OD Cone Tipped Needle for 10 µL CTC/Thermo Syringes PK2
037875	5.7 cm 0.47 mm OD Cone Tipped Needle for 10 µL CTC RTC & Thermo RSH Syringes PK2
037871	5.7 cm 0.63 mm OD Cone Tipped Needle for 10 µL CTC RTC & Thermo RSH Syringes PK2
037030	7 cm 0.47 mm OD Cone Tipped Needle for 10 µL Syringes PK2
037031	7 cm 0.63 mm OD Cone Tipped Needle for 10 µL Syringes PK2
031535	8 cm 0.47 mm OD Cone Tipped Needle for 10 µL CTC/Thermo Syringes PK3
037040	8 cm 0.63 mm OD Cone Tipped Needle for 10 µL Syringes PK2
037877	8.5 cm 0.47 mm OD Cone Tipped Needle for 10 µL CTC RTC & Thermo RSH Syringes PK2
037873	8.5 cm 0.63 mm OD Cone Tipped Needle for 10 µL CTC RTC & Thermo RSH Syringes PK2
<b>Side Hole, Dome Tipped</b>	
037410	5 cm 0.47 mm OD Side Hole Dome Tipped Needle for 10 µL Syringes PK2
037780	5.3 cm 0.50 mm OD Side Hole Dome Tipped Needle for 10 µL Varian 8200 series Syringes PK1
037777	5.3 cm 0.50 mm OD Side Hole Dome Tipped Needle for 10 µL Varian 8200 series Syringes PK2
037779	5.3 cm 0.63 mm OD Side Hole Dome Tipped Needle for 10 µL Varian 8200 series Syringes PK2
<b>LC Tipped</b>	
037250	5.1 cm 0.72 mm OD LC Tipped Needle for 10 µL Syringes PK5
037880	5.7 cm 0.72 mm OD LC Tipped Needle for 10 µL CTC RTC & Thermo RSH Syringes PK2

Part Number	Part Description and Detail
<b>Needles for 25-500 µL Syringes</b> (Note: 500 µL eVol Syringes use "Needles for 1-2.5 mL Syringes" - see below)	
<b>Bevel Tipped</b>	
038110	5 cm 0.50 mm OD Bevel Tipped Needle for 25-500 µL Syringes PK5
038111	5 cm 0.63 mm OD Bevel Tipped Needle for 25-500 µL Syringes PK5
038130	7 cm 0.50 mm OD Bevel Tipped Needle for 25-500 µL Syringes PK5
038131	7 cm 0.63 mm OD Bevel Tipped Needle for 25-500 µL Syringes PK5
038160	11.5 cm 0.50 mm OD Bevel Tipped Needle for 25-500 µL Syringes PK5
038161	11.5 cm 0.63 mm OD Bevel Tipped Needle for 25-500 µL Syringes PK5
038138	18 cm 0.63 mm OD Bevel Tipped Needle for 25-500 µL Syringes PK2
<b>Cone Tipped</b>	
038717	4.2 cm 0.63 mm OD Cone Tipped Needle for 25-500 µL Agilent Syringes PK2
038732	5 cm 0.47 mm OD Cone Tipped Needle for 25-500 µL CTC/Thermo Syringes PK2
038010	5 cm 0.50 mm OD Cone Tipped Needle for 25-500 µL Syringes PK2
038030	7 cm 0.50 mm OD Cone Tipped Needle for 25-500 µL Syringes PK2
038040	8 cm 0.63 mm OD Cone Tipped Needle for 25-500 µL Syringes PK2
038060	11.5 cm 0.50 mm OD Cone Tipped Needle for 25-500 µL Syringes PK2
038038	18 cm 0.63 mm OD Cone Tipped Needle for 25-500 µL Syringes PK2
<b>Side Hole, Dome Tipped</b>	
038749	5 cm 0.47 mm OD Side Hole Dome Tipped Needle for 25-500 µL Syringes PK2
038410	5 cm 0.50 mm OD Side Hole Dome Tipped Needle for 25-500 µL Syringes PK2
038736	5 cm 0.63 mm OD Side Hole Dome Tipped Needle for 25-500 µL CTC/Thermo Syringes PK2
<b>LC Tipped</b>	
038260	5 cm 0.50 mm OD LC (Waters) Tipped Needle for 25-500 µL Syringes PK5
038250	5.1 cm 0.72 mm OD LC Tipped Needle for 25-500 µL Syringes PK5
038270	7 cm 0.72 mm OD LC Tipped Needle for 25-500 µL Syringes PK5
038270	7 cm 0.72 mm OD LC Tipped Needle for 25-500 µL Syringes PK5
<b>Needles for 1-2.5 mL Syringes</b> (& 500 µL eVol Syringes)	
<b>Bevel Tipped</b>	
039112	5 cm 0.47/0.63 mm OD Dual Gauge Bevel Tipped Needle for 1-2.5 mL Syringes (& 500 µL eVol Syringes) PK2
039110	5 cm 0.63 mm OD Bevel Tipped Needle for 1-2.5 mL Syringes (& 500 µL eVol Syringes) PK5
039115	5 cm 0.72 mm OD Bevel Tipped Needle for 1-2.5 mL Syringes (& 500 µL eVol Syringes) PK2
039125	5.6 cm 0.63 mm OD Bevel Tipped Needle for 1-2.5 mL Syringes (& 500 µL eVol Syringes) PK5
039130	7 cm 0.63 mm OD Bevel Tipped Needle for 1-2.5 mL Syringes (& 500 µL eVol Syringes) PK5
039160	11.5 cm 0.63 mm OD Bevel Tipped Needle for 1-2.5 mL Syringes (& 500 µL eVol Syringes) PK5
039138	18 cm 0.63 mm OD Bevel Tipped Needle for 1-2.5 mL Syringes (& 500 µL eVol Syringes) PK2
<b>Cone Tipped</b>	
039161	7 cm 0.63 mm OD Cone Tipped Needle for 1-2.5 mL Syringes (& 500 µL eVol Syringes) PK2
039040	8 cm 0.63 mm OD Cone Tipped Needle for 1-2.5 mL Syringes (& 500 µL eVol Syringes) PK2
039060	11.5 cm 0.63 mm OD Cone Tipped Needle for 1-2.5 mL Syringes (& 500 µL eVol Syringes) PK5
039038	18 cm 0.63 mm OD Cone Tipped Needle for 1-2.5 mL Syringes (& 500 µL eVol Syringes) PK2
<b>Side Hole, Dome Tipped</b>	
039116	5 cm 0.63 mm OD Dome Tipped Needle for 1-2.5 mL Syringes (& 500 µL eVol Syringes) PK2
039120	5 cm 0.63 mm OD Side Hole Dome Tipped Needle for 1-2.5 mL Syringes (& 500 µL eVol Syringes) PK2
039440	8 cm 0.63 mm OD 0.24 mm ID Dual Side Hole Dome Tipped Needle for 1-2.5 mL Syringes (& 500 µL eVol Syringes) PK2
<b>LC Tipped</b>	
039260	5 cm 0.50 mm OD LC (Waters) Tipped Needle for 1-2.5 mL Syringes (& 500 µL eVol Syringes) PK5
039250	5.1 cm 0.72 mm OD LC Tipped Needle for 1-2.5 mL Syringes (& 500 µL eVol Syringes) PK5
039256	5.6 cm 0.72 mm OD LC Tipped Needle for 1-2.5 mL Syringes (& 500 µL eVol Syringes) PK5
039280	5.7 cm 0.72 mm OD LC Tipped Needle for 1-2.5 mL CTC RTC & Thermo RSH Syringes PK2
<b>Needles for 5-10 mL Syringes</b>	
<b>Bevel Tipped</b>	
031516	5 cm 0.63 mm OD 0.32 mm ID Bevel Tipped Needle for 5-10 mL Syringes PK5
<b>Dome Tipped</b>	
0315440	8 cm 0.63 mm OD 0.37 mm ID Dual Side Hole Dome Tipped Needle for 5-10 mL Syringes PK2
<b>LC Tipped</b>	
0315234	5 cm 0.50 mm OD 0.20 mm ID LC (Waters) Tipped Needle for 5-10 mL Syringes PK5
0315233	5.1 cm 0.72 mm OD 0.37 mm ID LC Tipped Needle for 5-10 mL Syringes PK5
031590	5.7 cm 1.07 mm OD 0.65 mm ID LC Tipped Needle for 5-10 mL CTC RTC & Thermo RSH Syringes PK2
<b>Needles for Syringe Valves</b>	
038810	5 cm 0.63 mm OD Cone Tipped Needle for 25 µL -2.5 mL Syringe Valve PK1
038815	5 cm 0.63 mm OD Side Hole Dome Tipped Needle for 25 µL -2.5 mL Syringe Valve PK1
<b>Needles for Luer Locks</b>	
<b>Bevel Tipped</b>	
039802	Luer Lock 5 cm 0.63 mm OD Bevel Tipped Needle PK5
039822	Luer Lock 5 cm 1.07 mm OD Bevel Tipped Needle PK5
039842	Luer Lock 5 cm 1.27 mm OD Bevel Tipped Needle PK5

Part Number	Part Description and Detail
039862	Luer Lock 5 cm 1.57 mm OD Bevel Tipped Needle PK5
039880	Luer Lock 5 cm 2.1 mm OD Bevel Tipped Needle PK5
039807	Luer Lock 7 cm 0.63 mm OD Bevel Tipped Needle PK5
039827	Luer Lock 7 cm 1.07 mm OD Bevel Tipped Needle PK5
039847	Luer Lock 7 cm 1.27 mm OD Bevel Tipped Needle PK5
039867	Luer Lock 7 cm 1.57 mm OD Bevel Tipped Needle PK5
039811	Luer Lock 11.5 cm 0.63 mm OD Bevel Tipped Needle PK5
039831	Luer Lock 11.5 cm 1.07 mm OD Bevel Tipped Needle PK5
039851	Luer Lock 11.5 cm 1.27 mm OD Bevel Tipped Needle PK5
039871	Luer Lock 11.5 cm 1.57 mm OD Bevel Tipped Needle PK5
039891	Luer Lock 11.5 cm 2.1 mm OD Bevel Tipped Needle PK5
<b>Side Hole, Dome Tipped</b>	
039803	Luer Lock 5 cm 0.63 mm OD Side Hole Dome Tipped Needle PK2
039823	Luer Lock 5 cm 1.07 mm OD Side Hole Dome Tipped Needle PK2
039808	Luer Lock 7 cm 0.63 mm OD Side Hole Dome Tipped Needle PK2
039809	Luer Lock 7 cm 0.63 mm OD Dual Side Hole Dome Tipped Needle (TOC2) PK2
<b>LC Tipped</b>	
039897	Luer Lock 5 cm 0.50 mm OD LC (Waters) Tipped Needle PK2
039895	Luer Lock 5.1 cm 0.72 mm OD LC Tipped Needle PK2
<b>Needles for On-Column Syringes</b>	
037675	7.5 cm 0.23 mm OD Needle for 10 µL On-Column Syringes PK2
037610	10 cm 0.17 mm OD Vitreous Silica Needle for 10 µL On-Column Syringes PK2
<b>Needles for Diamond MS Syringes</b>	
<b>Ultra Smooth Hydrophilic Coated</b>	
<b>Manual and Autosampler</b>	
0355310	Ultra Smooth Hydrophilic Coated 50 mm 0.47 mm OD 0.11 mm ID Bevel Tipped Needle for 10-50 µL Manual Diamond MS Syringes
0355311	Ultra Smooth Hydrophilic Coated 50 mm 0.50 mm OD 0.20 mm ID Bevel Tipped Needle for 10-50 µL Manual Diamond MS Syringes
0355312	Ultra Smooth Hydrophilic Coated 50 mm 0.50 mm OD 0.20 mm ID Bevel Tipped Needle for 100-500 µL Manual Diamond MS Syringes
0355313	Ultra Smooth Hydrophilic Coated 50 mm 0.63 mm OD 0.32 mm ID Bevel Tipped Needle for 100-500 µL Manual Diamond MS Syringes
0355210	Ultra Smooth Hydrophilic Coated 51 mm 0.72 mm OD 0.17 mm ID LC Tipped Needle for 10-50 µL Manual and Autosampler Diamond MS Syringes
0355211	Ultra Smooth Hydrophilic Coated 51 mm 0.72 mm OD 0.17 mm ID LC Tipped Needle for 100-500 µL Manual and Autosampler Diamond MS Syringes
0355213	Ultra Smooth Hydrophilic Coated 51 mm 0.72 mm OD 0.37 mm ID LC Tipped Needle for 100-500 µL Manual and Autosampler Diamond MS Syringes
0355215	Ultra Smooth Hydrophilic Coated 57 mm 0.72 mm OD 0.17 mm ID LC Tipped Needle for 10-50 µL Manual and Autosampler Diamond MS Syringes
0355216	Ultra Smooth Hydrophilic Coated 57 mm 0.72 mm OD 0.17 mm ID LC Tipped Needle for 100-500 µL Manual and Autosampler Diamond MS Syringes
<b>Agilent &amp; Shimadzu GC Autosampler</b>	
0355411	Ultra Smooth Hydrophilic Coated 42 mm 0.63 mm OD 0.11 mm ID Cone Tipped Needle for 10-50 µL Agilent & Shimadzu GC Autosampler Diamond MS Syringes
0355410	Ultra Smooth Hydrophilic Coated 42 mm 0.63 mm OD 0.24 mm ID Cone Tipped Needle for 10-50 µL Agilent & Shimadzu GC Autosampler Diamond MS Syringes
<b>CTC GC Autosampler</b>	
0355512	Ultra Smooth Hydrophilic Coated 50 mm 0.63 mm OD 0.11 mm ID Cone Tipped Needle for 10-50 µL CTC GC Autosampler Diamond MS Syringes
0355510	Ultra Smooth Hydrophilic Coated 50 mm 0.63 mm OD 0.24 mm ID Cone Tipped Needle for 10-50 µL CTC GC Autosampler Diamond MS Syringes
0355511	Ultra Smooth Hydrophilic Coated 50 mm 0.63 mm OD 0.24 mm ID Cone Tipped Needle for 100-500 µL CTC GC Autosampler Diamond MS Syringes
<b>CTC RTC &amp; Thermo RSH GC Autosampler</b>	
0355612	Ultra Smooth Hydrophilic Coated 57 mm 0.63 mm OD 0.11 mm ID Cone Tipped Needle for 10-50 µL CTC RTC & Thermo RSH GC Autosampler Diamond MS Syringes
0355610	Ultra Smooth Hydrophilic Coated 57 mm 0.63 mm OD 0.24 mm ID Cone Tipped Needle for 10-50 µL CTC RTC & Thermo RSH GC Autosampler Diamond MS Syringes
0355611	Ultra Smooth Hydrophilic Coated 57 mm 0.63 mm OD 0.24 mm ID Cone Tipped Needle for 100-500 µL CTC RTC & Thermo RSH GC Autosampler Diamond MS Syringes
<b>Ultra Smooth Hydrophobic Coated</b>	
<b>Manual and Autosampler</b>	
0355320	Ultra Smooth Hydrophobic Coated 50 mm 0.47 mm OD 0.11 mm ID Bevel Tipped Needle for 10-50 µL Manual Diamond MS Syringes
0355321	Ultra Smooth Hydrophobic Coated 50 mm 0.50 mm OD 0.20 mm ID Bevel Tipped Needle for 10-50 µL Manual Diamond MS Syringes
0355322	Ultra Smooth Hydrophobic Coated 50 mm 0.50 mm OD 0.20 mm ID Bevel Tipped Needle for 100-500 µL Manual Diamond MS Syringes
0355323	Ultra Smooth Hydrophobic Coated 50 mm 0.63 mm OD 0.32 mm ID Bevel Tipped Needle for 100-500 µL Manual Diamond MS Syringes
0355220	Ultra Smooth Hydrophobic Coated 51 mm 0.72 mm OD 0.17 mm ID LC Tipped Needle for 10-50 µL Manual and Autosampler Diamond MS Syringes
0355221	Ultra Smooth Hydrophobic Coated 51 mm 0.72 mm OD 0.17 mm ID LC Tipped Needle for 100-500 µL Manual and Autosampler Diamond MS Syringes
0355223	Ultra Smooth Hydrophobic Coated 51 mm 0.72 mm OD 0.37 mm ID LC Tipped Needle for 100-500 µL Manual and Autosampler Diamond MS Syringes
0355225	Ultra Smooth Hydrophobic Coated 57 mm 0.72 mm OD 0.17 mm ID LC Tipped Needle for 10-50 µL Manual and Autosampler Diamond MS Syringes
0355226	Ultra Smooth Hydrophobic Coated 57 mm 0.72 mm OD 0.17 mm ID LC Tipped Needle for 100-500 µL Manual and Autosampler Diamond MS Syringes
<b>Agilent &amp; Shimadzu GC Autosampler</b>	
0355421	Ultra Smooth Hydrophobic Coated 42 mm 0.63 mm OD 0.11 mm ID Cone Tipped Needle for 10-50 µL Agilent & Shimadzu GC Autosampler Diamond MS Syringes
0355420	Ultra Smooth Hydrophobic Coated 42 mm 0.63 mm OD 0.24 mm ID Cone Tipped Needle for 10-50 µL Agilent & Shimadzu GC Autosampler Diamond MS Syringes

Part Number	Part Description and Detail
<b>CTC GC Autosampler</b>	
0355522	Ultra Smooth Hydrophobic Coated 50 mm 0.63 mm OD 0.11 mm ID Cone Tipped Needle for 10-50 µL CTC GC Autosampler Diamond MS Syringes
0355520	Ultra Smooth Hydrophobic Coated 50 mm 0.63 mm OD 0.24 mm ID Cone Tipped Needle for 10-50 µL CTC GC Autosampler Diamond MS Syringes
0355521	Ultra Smooth Hydrophobic Coated 50 mm 0.63 mm OD 0.24 mm ID Cone Tipped Needle for 100-500 µL CTC GC Autosampler Diamond MS Syringes
<b>CTC RTC &amp; Thermo RSH GC Autosampler</b>	
0355622	Ultra Smooth Hydrophobic Coated 57 mm 0.63 mm OD 0.11 mm ID Cone Tipped Needle for 10-50 µL CTC RTC & Thermo RSH GC Autosampler Diamond MS Syringes
0355620	Ultra Smooth Hydrophobic Coated 57 mm 0.63 mm OD 0.24 mm ID Cone Tipped Needle for 10-50 µL CTC RTC & Thermo RSH GC Autosampler Diamond MS Syringes
0355621	Ultra Smooth Hydrophobic Coated 57 mm 0.63 mm OD 0.24 mm ID Cone Tipped Needle for 100-500 µL CTC RTC & Thermo RSH GC Autosampler Diamond MS Syringes
<b>Ultra Smooth</b>	
<b>Manual and Autosampler</b>	
0355330	Ultra Smooth 50 mm 0.47 mm OD 0.11 mm ID Bevel Tipped Needle for 10-50 µL Manual Diamond MS Syringes
0355331	Ultra Smooth 50 mm 0.50 mm OD 0.20 mm ID Bevel Tipped Needle for 10-50 µL Manual Diamond MS Syringes
0355332	Ultra Smooth 50 mm 0.50 mm OD 0.20 mm ID Bevel Tipped Needle for 100-500 µL Manual Diamond MS Syringes
0355333	Ultra Smooth 50 mm 0.63 mm OD 0.32 mm ID Bevel Tipped Needle for 100-500 µL Manual Diamond MS Syringes
0355230	Ultra Smooth 51 mm 0.72 mm OD 0.17 mm ID LC Tipped Needle for 10-50 µL Manual and Autosampler Diamond MS Syringes
0355231	Ultra Smooth 51 mm 0.72 mm OD 0.17 mm ID LC Tipped Needle for 100-500 µL Manual and Autosampler Diamond MS Syringes
0355233	Ultra Smooth 51 mm 0.72 mm OD 0.37 mm ID LC Tipped Needle for 100-500 µL Manual and Autosampler Diamond MS Syringes
0355235	Ultra Smooth 57 mm 0.72 mm OD 0.17 mm ID LC Tipped Needle for 10-50 µL Manual and Autosampler Diamond MS Syringes
0355236	Ultra Smooth 57 mm 0.72 mm OD 0.17 mm ID LC Tipped Needle for 100-500 µL Manual and Autosampler Diamond MS Syringes
<b>Agilent &amp; Shimadzu GC Autosampler</b>	
0355431	Ultra Smooth 42 mm 0.63 mm OD 0.11 mm ID Cone Tipped Needle for 10-50 µL Agilent & Shimadzu GC Autosampler Diamond MS Syringes
0355430	Ultra Smooth 42 mm 0.63 mm OD 0.24 mm ID Cone Tipped Needle for 10-50 µL Agilent & Shimadzu GC Autosampler Diamond MS Syringes
<b>CTC GC Autosampler</b>	
0355532	Ultra Smooth 50 mm 0.63 mm OD 0.11 mm ID Cone Tipped Needle for 10-50 µL CTC GC Autosampler Diamond MS Syringes
0355530	Ultra Smooth 50 mm 0.63 mm OD 0.24 mm ID Cone Tipped Needle for 10-50 µL CTC GC Autosampler Diamond MS Syringes
0355531	Ultra Smooth 50 mm 0.63 mm OD 0.24 mm ID Cone Tipped Needle for 100-500 µL CTC GC Autosampler Diamond MS Syringes
<b>CTC RTC &amp; Thermo RSH GC Autosampler</b>	
0355632	Ultra Smooth 57 mm 0.63 mm OD 0.11 mm ID Cone Tipped Needle for 10-50 µL CTC RTC & Thermo RSH GC Autosampler Diamond MS Syringes
0355630	Ultra Smooth 57 mm 0.63 mm OD 0.24 mm ID Cone Tipped Needle for 10-50 µL CTC RTC & Thermo RSH GC Autosampler Diamond MS Syringes
0355631	Ultra Smooth 57 mm 0.63 mm OD 0.24 mm ID Cone Tipped Needle for 100-500 µL CTC RTC & Thermo RSH GC Autosampler Diamond MS Syringes

For more information visit [www.sge.com](http://www.sge.com) or contact [techsupport@sge.com](mailto:techsupport@sge.com).





## Syringes | Replacement Plungers

Wide range of replacement plungers available to suit SGE gas tight syringes 10  $\mu$ L - 100 mL.

### Recommended Applications

Spare parts for gas tight syringes.

---

### Product Specifications

PTFE plunger tip, and either stainless steel (10  $\mu$ L - 1 mL), black anodized aluminium (2.5 mL - 25 mL), or polyacetal resin (50 mL - 100 mL), plunger stems.

For more information about this product visit [www.sge.com](http://www.sge.com) or contact [techsupport@sge.com](mailto:techsupport@sge.com).



## Syringes | Cross Reference Hamilton

Variation Notes:  
 FN = Fixed Needle, GT = Gas Tight, with PTFE Tipped plunger, H = Hamilton, LL = Luer Lock, LT = Luer Tip, RN = Removable Needle, WO = Without

Hamilton Part Number	Part Description and Detail	SGE Part Number	Part Description and Detail	Equivalent or Option	Variation
0160310	1750 HITACHI SYRINGE	007660	500 µL Hitachi LC Autosampler Syringe with GT Plunger with M10 - 1.0 Screw Thread	E	
202640	701RSN AOC 14/17(22s/1.69 "/2)	002898	10 µL Removable Needle Shimadzu Syringe with 4.2 cm 0.63 mm OD Cone Tipped Needle	O	23 g Needle
202660	1002LTN CTC SYR (22/56/5)	008631	2.5 mL Fixed Needle CTC Head Space Syringe with Energized GT Plunger and 5.6 cm 0.63 mm OD Side-hole Needle	O	23 g Needle
202880	701RN VARIAN 8100/8200	002924	10 µL Removable Needle CTC/Thermo (Classic Button) Syringe with GT Plunger & 5.3 cm 0.5 mm OD Needle	O	25 g Needle
203043	1702N CTC SYRINGE (26s/51/AS)	003700	25 µL Fixed Needle CTC Syringe with GT Plunger & 5 cm 0.47 mm OD Cone Tipped Needle	E	
203072	SYR,701 CTC,SLIM (26s/51/2)	002980	10 µL Fixed Needle CTC/Thermo Syringe with 5 cm 0.47 mm OD Cone Tipped Needle	O	Cone Tipped Needle
203073	701N CTC SYRINGE (22s/51/3)	002710	10 µL Fixed Needle CTC Syringe with 5.1 cm 0.72 mm OD LC Needle	E	
203074	SYR,1702CTC,SLIM (26s/51/AS)	0039871	25 µL Fixed Needle CTC/Thermo (Classic Button) Syringe with GT Plunger & 5 cm 0.63 mm OD Cone Tipped Needle	E	23 g Needle
203075	1702N CTC SYRINGE (22s/51/3)	003715	25 µL Fixed Needle CTC Syringe with GT Plunger & 5.1 cm 0.72 mm OD LC Needle (8 mm OD barrel)	E	
203076	SYR,1710 CTC,SLIM (26s/51/AS)	005700	100 µL Fixed Needle CTC Syringe with GT Plunger & 5 cm 0.47 mm OD Cone Tipped Needle	E	
203077	SYR,1710N CTC,SLIM (22s/51/3)	005715	100 µL Fixed Needle CTC Syringe with GT Plunger & 5.1 cm 0.72 mm OD LC Needle	E	
203078	1725N CTC SYRINGE (26/51/AS)	006700	250 µL Fixed Needle CTC Syringe with GT Plunger & 5 cm 0.47 mm OD Cone Tipped Needle	E	
203082	1001LTN CTC SYRINGE (23/51/5)	008131	1 mL Fixed Needle CTC Head Space Syringe with Energized GT Plunger and 5.6 cm 0.63 mm OD Side-hole Needle	E	
203084	1002LTN CTC SYRINGE (23/51/5)	008631	2.5 mL Fixed Needle CTC Head Space Syringe with Energized GT Plunger and 5.6 cm 0.63 mm OD Side-hole Needle	E	
203141	1001LTN CTC SYRINGE (26/51/5)	008136	1 mL Fixed Needle CTC Head Space Syringe with Energized GT Plunger and 5.6 cm 0.47 mm OD Side-hole Needle	E	
203181	1002LTN CTC SYRINGE (26/51/5)	008636	2.5 mL Fixed Needle CTC Head Space Syringe with Energized GT Plunger and 5.6 cm 0.47 mm OD Side-hole Needle	E	
203185	7701.2 CTC SYRINGE (26/51/AS)	000790	2.0 µL NanoVolume CTC/Thermo Syringe with 5.0 cm 0.63 mm OD Cone Tipped Needle	O	2 µL Instead of 1 µL
203189	75N CTC SYRINGE (26s/51/AS)	001982	5 µL Fixed Needle CTC/Thermo Syringe with 5 cm 0.47 mm OD Cone Tipped Needle	E	
203205	701N CTC SYRINGE (26s/51/AS)	002700	10 µL Fixed Needle CTC Syringe with 5 cm 0.47 mm OD Cone Tipped Needle	E	
203235	1710N CTC SYRINGE (22/51/3)	005720	100 µL Fixed Needle CTC Syringe with GT Plunger & 5.1 cm 0.72 mm OD (0.4 mm ID) LC Needle	E	
203349	1750N CTC SYR (22/51/3)	007720	500 µL Fixed Needle CTC Syringe with GT Plunger & 5.1 cm 0.72 mm OD (0.4 mm ID) LC Needle	E	
203361	701N CTC SYR (23S/51/AS)	002981	10 µL Fixed Needle CTC/Thermo Syringe with 5 cm 0.63 mm OD Cone Tipped Needle	E	
203362	701N CTC SYR (23S-26S/51/AS)	002980	10 µL Fixed Needle CTC/Thermo Syringe with 5 cm 0.47 mm OD Cone Tipped Needle	O	26 g Needle
203363	701N CTC SYR (23S/2 "/2)	002981	10 µL Fixed Needle CTC/Thermo Syringe with 5 cm 0.63 mm OD Cone Tipped Needle	O	Cone Tipped Needle
203566	1710 CTC A200S SYR (22s/2/3)	005331	100 µL Fixed Needle CTC/Thermo Syringe with GT Plunger & 5.1 cm 0.72 mm OD LC Needle	E	
204000	SYRINGE,75N(26S/50/2)	0019821	5 µL Fixed Needle CTC/Thermo (Classic Button) Syringe with 5 cm 0.47 mm OD Cone Tipped Needle	O	Cone Tipped Needle
204001	SYRINGE,701SN(26S/50/2)	0029801	10 µL Fixed Needle CTC/Thermo (Classic Button) Syringe with 5 cm 0.47 mm OD Cone Tipped Needle	O	Cone Tipped Needle
204051	SYRINGE,75SN(26S/50/AS)	0019821	5 µL Fixed Needle CTC/Thermo (Classic Button) Syringe with 5 cm 0.47 mm OD Cone Tipped Needle	E	
204052	SYRINGE,701SN 26S/50/AS)	0029801	10 µL Fixed Needle CTC/Thermo (Classic Button) Syringe with 5 cm 0.47 mm OD Cone Tipped Needle	E	

Syringes | Cross Reference Hamilton Continued

Hamilton Part Number	Part Description and Detail	SGE Part Number	Part Description and Detail	Equivalent or Option	Variation
207189	701 PAL3 (56S/85/AS)	002867	10 µL Fixed Needle CTC RTC & Thermo RSH Syringe with 8.5 cm 0.47 mm OD Cone Tipped Needle	E	
207290	1002 CTC PAL3 (23/65/5)HS	008655	2.5 mL Fixed Needle CTC RTC & Thermo RSH Head Space Syringe with Energized GT Plunger and 5.6 cm 0.63 mm OD Side-hole Needle	E	
207292	1010 CTC PAL3(19/57/3)	008951	10 mL Removable Needle CTC RTC & Thermo RSH Syringe with GT Plunger & 5.7 cm 1.07 mm OD LC Tipped Needle	E	
207803	701 PAL3 (23S/57/AS)	002861	10 µL Fixed Needle CTC RTC & Thermo RSH Syringe with 5.7 cm 0.63 mm OD Cone Tipped Needle	E	
207807	701 PAL3 (26S/57/AS)	002865	10 µL Fixed Needle CTC RTC & Thermo RSH Syringe with 5.7 cm 0.47 mm OD Cone Tipped Needle	E	
207813	1701 PAL3 (22S/57/3)	002880	10 µL Removable Needle CTC RTC & Thermo RSH Syringe with GT Plunger & 5.7 cm 0.72 mm OD LC Needle	E	
207829	1725 PAL3 (23/57/AS)	006862	250 µL Fixed Needle CTC RTC & Thermo RSH Syringe with GT Plunger & 5.7 cm 0.63 mm OD Cone Tipped Needle	E	
207831	1725 PAL3 (26/85/AS)	006862	250 µL Fixed Needle CTC RTC & Thermo RSH Syringe with GT Plunger & 5.7 cm 0.63 mm OD Cone Tipped Needle	E	
207836	1001 PAL3 (22/57/3)	008150	1 mL Fixed Needle CTC RTC & Thermo RSH Syringe with GT Plunger & 5.7 cm 0.72 mm OD LC Tipped Needle	E	
207837	1701 PAL3 (26S/57/AS)	002866	10 µL Fixed Needle CTC RTC & Thermo RSH Syringe with GT Plunger & 5.7 cm 0.47 mm OD Cone Tipped Needle	E	
207839	1701 PAL3 (23S/57/AS)	002862	10 µL Fixed Needle CTC RTC & Thermo RSH Syringe with GT Plunger & 5.7 cm 0.63 mm OD Cone Tipped Needle	E	
207840	1710 PAL3 (26S/57/AS)	005866	100 µL Fixed Needle CTC RTC & Thermo RSH Syringe with GT Plunger & 5.7 cm 0.47 mm OD Cone Tipped Needle	E	
207853	1001 CTC PAL3 (23/65/5)HS	008155	1 mL Fixed Needle CTC RTC & Thermo RSH Head Space Syringe with Energized GT Plunger and 6.5 cm 0.63 mm OD Side-hole Needle	E	
208311	1710 CTC SYR X PAL3 (22/57/3)	008950	10 mL Fixed Needle CTC RTC & Thermo RSH Syringe with GT Plunger & 5.7 cm 1.07 mm OD LC Tipped Needle	E	
208312	1710 CTC SYR X PAL3 (22S/57/3)	008950	10 mL Fixed Needle CTC RTC & Thermo RSH Syringe with GT Plunger & 5.7 cm 1.07 mm OD LC Tipped Needle	E	
54658-01	SYRINGE,1710C,AUTO SAMPLER	005696	100 µL V6 Dispenser Syringe	E	
54659-01	SYRINGE,1725C,AUTO SAMPLER	006696	250 µL V6 Dispenser Syringe	E	
54660-01	SYRINGE, 1750C,AUTO SAMPLER	007696	500 µL V6 Dispenser Syringe	E	
54661-01	SYRINGE,1001C,AUTO SAMPLER	008196	1.0 mL V6 Dispenser Syringe	E	
54662-01	SYRINGE,1002C,AUTO SAMPLER	008596	2.5 mL V6 Dispenser Syringe	E	
62161-01	SYRINGE,1702C,SPARK AUTO	003696	25 µL V6 Dispenser Syringe	E	
67430-01	SYR,1702N,(23/51/AS),CTC-S	003700	25 µL Fixed Needle CTC Syringe with GT Plunger & 5 cm 0.47 mm OD Cone Tipped Needle	E	
67432-01	SYR,1710N,(22S/51/3),CTC-S-X	005331	100 µL Fixed Needle CTC/Thermo Syringe with GT Plunger & 5.1 cm 0.72 mm OD LC Needle	E	
67434-01	SYR,1710N,(23/51/AS),CTC-S	005335	100 µL Fixed Needle CTC/Thermo Syringe with GT Plunger & 5 cm 0.63 mm OD Cone Tipped Needle	E	
67436-01	SYR,75N,(26S/51/AS),CTC-S	0019821	5 µL Fixed Needle CTC/Thermo (Classic Button) Syringe with 5 cm 0.47 mm OD Cone Tipped Needle	E	
67438-01	SYR,701N,(26S/51/AS),CTC-S	0029801	10 µL Fixed Needle CTC/Thermo (Classic Button) Syringe with 5 cm 0.47 mm OD Cone Tipped Needle	E	
67440-01	SYR,701SN,(23S/51/AS),CTC-S	002951	10 µL Fixed Needle Varian 8400/CTC/Thermo (Classic Button) Syringe with 5 cm 0.63 mm OD Cone Tipped Needle	E	
67442-01	SYR,1725N,(22/51/3),CTC-S	006330	250 µL Removeable Needle CTC Syringe with GT Plunger & 5.1 cm 0.72 mm OD (0.4 mm ID) LC Needle	E	
67446-01	SYR,1702N,(22S/51/3),CTC-S	003715	25 µL Fixed Needle CTC Syringe with GT Plunger & 5.1 cm 0.72 mm OD LC Needle (8 mm OD barrel)	E	
67448-01	SYR,1750N,(22/51/3),CTC-S	007720	500 µL Fixed Needle CTC Syringe with GT Plunger & 5.1 cm 0.72 mm OD (0.4 mm ID) LC Needle	E	
67450-01	SYR,1705N,(22/51/3),CTC-S	004810	50 µL Fixed Needle CTC Syringe with GT Plunger & 5.1 cm 0.72 mm OD LC Needle	E	
67452-01	SYR,1710SN,(22S/51/3),CTC-S	005715	100 µL Fixed Needle CTC Syringe with GT Plunger & 5.1 cm 0.72 mm OD LC Needle	E	
67454-01	SYR,1701SN,(23S/51/AS),CTC-S	0029871	10 µL Fixed Needle CTC/Thermo (Classic Button) Syringe with GT Plunger & 5 cm 0.63 mm OD Cone Tipped Needle	E	
80000	1701N 10 µL SYR (26s/2 * /2)	002200	10 µL Fixed Needle Syringe with GT Plunger & 5 cm 0.47 mm OD Bevel Tipped Needle	E	
80004	1701NCH 10 µL SYR (26s/2 * /2)	002200 + 031930	10 µL Fixed Needle Syringe with GT Plunger & 5 cm 0.47 mm OD Bevel Tipped Needle and Repeating Adaptor	E	
80020	1702 WISP SYR 25 µL	003990	25 µL Waters Wisp Syringe with GT Plunger	E	
80024	1725 WISP SYR 250 µL	006690	250 µL Waters Wisp Syringe with GT Plunger	E	
80030	1701RN 10 µL SYR (26s/2 * /2)	002250	10 µL Removable Needle Syringe with GT Plunger & 5 cm 0.47 mm OD Bevel Tipped Needle	E	
80039	1701NPT5 10 µL SYR (26s/2 * /5)	002250 + 037410	10 µL Removable Needle Syringe with GT Plunger & 5 cm Side Hole Dome Tipped Needle	E	

## Syringes | Cross Reference Hamilton Continued

Hamilton Part Number	Part Description and Detail	SGE Part Number	Part Description and Detail	Equivalent or Option	Variation
80065	1701RNR 10 µL SYR (22s/2 °/3)	002313	10 µL Removable Needle Syringe with GT Plunger & 5.1 cm 0.72 mm OD LC Needle	E	
80074	SYRINGE,175ASN,23S GA,1.71	001810	5 µL Fixed Needle Agilent Syringe with 4.2 cm 0.63 mm OD Cone Tipped Needle	O	Not GT (Note that H is Half Scale 10 µL)
80074	SYRINGE,175ASN,23S GA,1.71	002812	10 µL Fixed Needle Agilent Syringe with GT Plunger & 4.2 cm 0.63 mm OD Cone Tipped Needle	O	Full Scale 10 µL Instead of Half Scale 5 µL
80075	1701N 10 µL SYR (26s/2 °/3)	002335	10 µL Fixed Needle Syringe with GT Plunger & 5.1 cm 0.72 mm OD LC Needle	O	22 g Needle
80076	175ASN SYR (23-26/1.71 °/HP)	001821	5 µL Fixed Needle Agilent Syringe with 4.2 cm 0.63/0.47 mm OD Cone Tipped Dual Gauge Needle	O	Not GT (Note that H is Half Scale 10 µL)
80076	175ASN SYR (23-26/1.71 °/HP)	002826	10 µL Fixed Needle Agilent Syringe with GT Plunger & 4.2 cm 0.63/0.47 mm OD Cone Tipped Dual Gauge Needle	O	Full Scale 10 µL Instead of Half Scale 5 µL
80079	1701ASN SYR(23S/26S/1.71 °/HP)	002826	10 µL Fixed Needle Agilent Syringe with GT Plunger & 4.2 cm 0.63/0.47 mm OD Cone Tipped Dual Gauge Needle	E	
80080	1701ASN SYR (23s/1.71 °/HP)	002812	10 µL Fixed Needle Agilent Syringe with GT Plunger & 4.2 cm 0.63 mm OD Cone Tipped Needle	E	
80084	175ASRN(23s/1.71 °/HP)	002829	10 µL Removable Needle Agilent Syringe with GT Plunger & 4.2 cm 0.63/0.47 mm OD Cone Tipped Dual Gauge Needle	O	Dual Gauge Needle (Note that H 5 µL is Half Scale 10 µL)
80085	1701N 10 µL SYR (26/2 °/3)	002335	10 µL Fixed Needle Syringe with GT Plunger & 5.1 cm 0.72 mm OD LC Needle	O	22 g Needle
80086	175ASRN SYR (23-26/1.71 °/HP)	002829	10 µL Removable Needle Agilent Syringe with GT Plunger & 4.2 cm 0.63/0.47 mm OD Cone Tipped Dual Gauge Needle	O	Full Scale 10 µL Instead of Half Scale 5 µL
80087	1701ASRN 10 µL SYR 23s/1.71 °/HP	002829	10 µL Removable Needle Agilent Syringe with GT Plunger & 4.2 cm 0.63/0.47 mm OD Cone Tipped Dual Gauge Needle	O	Dual Gauge Needle
80088	1701ASRN 10 µL SYR 26s/1.71 °/HP	002829	10 µL Removable Needle Agilent Syringe with GT Plunger & 4.2 cm 0.63/0.47 mm OD Cone Tipped Dual Gauge Needle	O	Dual Gauge Needle
80089	1701ASRN SYR (23S/26S/1.71/HP)	002829	10 µL Removable Needle Agilent Syringe with GT Plunger & 4.2 cm 0.63/0.47 mm OD Cone Tipped Dual Gauge Needle	E	
80090	175ASN 5 µL (23S/1.71 °/HP) 6/PK	002812	10 µL Fixed Needle Agilent Syringe with GT Plunger & 4.2 cm 0.63 mm OD Cone Tipped Needle	O	Full Scale 10 µL Instead of Half Scale 5 µL
80090	175ASN 5 µL (23S/1.71 °/HP) 6/PK	002816	10 µL Removable Needle Agilent Syringe with 4.2 cm 0.63 mm OD Cone Tipped Needle PK25	O	Full Scale 10 µL Instead of Half Scale 5 µL
80092	175ASN 5 µL (23-26/1.71 °/HP)6/PK	002827	5 µL Fixed Needle Agilent Syringe with GT Plunger & 4.2 cm 0.63/0.47 mm OD Cone Tipped Dual Gauge Needle PK6	O	Full Scale 10 µL Instead of Half Scale 5 µL
80094	1701ASN SYR (23s/1.71 °/HP)6/PK	002812	10 µL Fixed Needle Agilent Syringe with GT Plunger & 4.2 cm 0.63 mm OD Cone Tipped Needle	O	
80094	1701ASN SYR (23s/1.71 °/HP)6/PK	002816	10 µL Fixed Needle Agilent Syringe with GT Plunger & 4.2 cm 0.63 mm OD Cone Tipped Needle PK25	O	
80096	1701ASN (23-26/1.71 °/HP) 6/PK	002827	5 µL Fixed Needle Agilent Syringe with GT Plunger & 4.2 cm 0.63/0.47 mm OD Cone Tipped Dual Gauge Needle PK6	E	
80100	7001KH 1 µL SYR (25/2.75 °/3)	000570	1.0 µL NanoVolume Syringe with 7 cm 0.47 mm OD Cone Tipped Needle	O	26 g, Cone Tipped Needle
80104	7001KHCH 1 µL SYR (25/2.75 °/3)	000570 + 031930	1.0 µL NanoVolume Syringe with 7 cm 0.47 mm OD Cone Tipped Needle and Repeating Adaptor	O	26 g, Cone Tipped Needle
80107	7001KHWG 1 µL SYR (25s/2.75 °/3)	000570 + 031930	1.0 µL NanoVolume Syringe with 7 cm 0.47 mm OD Cone Tipped Needle and Repeating Adaptor	O	26 g, Cone Tipped Needle
80135	7001KH 1.0 µL SYR (25/2.75 °/2)	000506	1.0 µL NanoVolume Syringe with 7 cm 0.63 mm OD Bevel Tipped Needle	O	23 g Needle
80175	7001ASRN (26/1.71 °/HP)	000610	1.0 µL NanoVolume Agilent Syringe with 4.2 cm 0.63 mm OD Cone Tipped Needle	O	23 g Needle
80176	7001ASRN (23/1.71 °/HP)	000610	1.0 µL NanoVolume Agilent Syringe with 4.2 cm 0.63 mm OD Cone Tipped Needle	E	
80200	1702N 25 µL SYR (22s/2 °/2)	003200	25 µL Fixed Needle Syringe with GT Plunger & 5 cm 0.5 mm OD Bevel Tipped Needle	O	25 g Needle
80201	1702LT 25 µL SYR	004229	50 µL Fixed Luer Tip Syringe with GT Plunger	O	50 µL
80222	1702TLLX 25 µL SYR	004232	50 µL Fixed Luer Lock Syringe with GT Plunger & Plunger Stop	O	50 µL
80223	1702TLLX SYR W/BSHG STD BTN	004232	50 µL Fixed Luer Lock Syringe with GT Plunger & Plunger Stop	O	50 µL
80230	1702RN 25 µL SYR (22s/2 °/2)	003250	25 µL Removable Needle Syringe with GT Plunger & 5 cm 0.5 mm OD Bevel Tipped Needle	O	25 g Needle
80238	1702RNW 25 µL SYR(25s/1.97 °/3)	003250 + 038260	25 µL Removable Needle Syringe with GT Plunger & Waters LC Tipped Needle	E	
80239	1702NPT5 25 µL SYR (22s/2 °/5)	003250 + 038410	25 µL Removable Needle Syringe with GT Plunger & 5 cm Side Hole Dome Tipped Needle	O	RN, 25 g Needle
80265	1702RNR 25 µL SYR (22s/2 °/3)	003312	25 µL Removable Needle Syringe with GT Plunger & 5.1 cm 0.72 mm OD LC Needle	E	

Syringes | Cross Reference Hamilton Continued

Hamilton Part Number	Part Description and Detail	SGE Part Number	Part Description and Detail	Equivalent or Option	Variation
80275	1702N 25 µL SYR (22s/2 "/3)	003300	25 µL Fixed Needle Syringe with 5.1 cm 0.72 mm OD LC Needle	O	Not GT
80285	1702N 25 µL SYR (22/2 "/3)	003300	25 µL Fixed Needle Syringe with 5.1 cm 0.72 mm OD LC Needle	O	Not GT
80300	701N 10 µL SYR (26s/2 "/2)	002000	10 µL Fixed Needle Syringe with 5 cm 0.47 mm OD Bevel Tipped Needle	E	Manual Use
80300	701N 10 µL SYR (26s/2 "/2)	002950	10 µL Fixed Needle Varian 8400 Syringe with 5 cm 0.47 mm OD Cone Tipped Needle	E	Bruker/Varian Autosamplers
80304	701NCH 10 µL SYR (26s/2 "/2)	002000 + 031930	10 µL Fixed Needle Syringe with 5 cm 0.47 mm OD Bevel Tipped Needle and Repeating Adaptor	E	
80307	701NWG 10 µL SYR (26s/2 "/2)	002000 + 031930	10 µL Fixed Needle Syringe with 5 cm 0.47 mm OD Bevel Tipped Needle and Repeating Adaptor	E	
80318	701SN 10 µL SYR (26s/3.15 "/HP)	0029921	10 µL Fixed Needle CTC/Thermo (Classic Button) Syringe with 8 cm 0.47 mm OD Cone Tipped Needle	E	
80330	701RN 10 µL SYR (26s/2 "/2)	002050	10 µL Removable Needle Syringe with 5 cm 0.47 mm OD Bevel Tipped Needle	E	
80334	701RNCH 10 µL SYR (26s/2 "/2)	002050 + 031930	10 µL Removable Needle Syringe with 5 cm 0.47 mm OD Bevel Tipped Needle and Repeating Adaptor	E	
80336	701RN 10 µL SYR 6/PK (26s/2 "/2)	002080	10 µL Removable Needle Syringe with 5 cm 0.47 mm OD Bevel Tipped Needle PK6	E	
80337	701RNWG 10 µL SYR (26s/2 "/2)	002050 + 031930	10 µL Removable Needle Syringe with 5 cm 0.47 mm OD Bevel Tipped Needle and Repeating Adaptor	E	
80339	701NPT5 10 µL SYR (26s/2 "/5)	002050 + 037410	10 µL Removable Needle Syringe with 5 cm Side Hole Dome Tipped Needle	O	RN
80342	701SN 10 µL SYR (23s/2 "/HP)	002005	10 µL Fixed Needle Syringe with 5 cm 0.47 mm OD Cone Tipped Needle	E	
80350	701SN 10 µL SYR (26s/2.75 "/2)	002003	10 µL Fixed Needle Syringe with 7 cm 0.47 mm OD Bevel Tipped Needle	E	
80357	701ASRN 10 µL SYR (23s/1.71 "/HP)	002815	10 µL Removable Needle Agilent Syringe with 4.2 cm 0.63 mm OD Cone Tipped Needle	E	
80358	701ASRN 10 µL SYR (26s/1.71 "/HP)	002805	10 µL Removable Needle Agilent Syringe with 4.2 cm 0.47 mm OD Cone Tipped Needle	E	
80359	701ASRN 10 µL (23-26/1.71 "/HP)	002829	10 µL Removable Needle Agilent Syringe with GT Plunger & 4.2 cm 0.63/0.47 mm OD Cone Tipped Dual Gauge Needle	O	GT
80360	901N 10 µL SYR (26s/2 "/2)	002400	10 µL Fixed Needle Guided Plunger Syringe with 5 cm 0.47 mm OD Bevel Tipped Needle	O	
80365	701SNR 10 µL SYR (22s/2 "/3)	002301	10 µL Fixed Needle Syringe with 5.1 cm 0.72 mm OD LC Needle	E	
80366	701N 10 µL SYR 6/PK (26s/2 "/2)	002030	10 µL Fixed Needle Syringe with 5 cm 0.47 mm OD Bevel Tipped Needle PK6	E	Manual Use
80370	901RN 10 µL SYR (26s/2 "/2)	002450	10 µL Removable Needle Guided Plunger Syringe with 5 cm 0.47 mm OD Bevel Tipped Needle	E	
80383	701SN 10 µL SYR (26s/2 "/3)	002301	10 µL Fixed Needle Syringe with 5.1 cm 0.72 mm OD LC Needle	E	
80384	701SN 10 µL SYR (26s/3 "/2)	002003	10 µL Fixed Needle Syringe with 7 cm 0.47 mm OD Bevel Tipped Needle	O	7 cm Needle
80387	701ASN 10 µL SYR (23s/1.71 "/HP)	002810	10 µL Fixed Needle Agilent Syringe with 4.2 cm 0.63 mm OD Cone Tipped Needle	E	
80388	701ASN 10 µL SYR (26s/1.71 "/HP)	002800	10 µL Fixed Needle Agilent Syringe with 4.2 cm 0.47 mm OD Cone Tipped Needle	E	
80389	701ASN 10 µL SYR-HP 26s (6/PK)	002804	10 µL Fixed Needle Agilent Syringe with 4.2 cm 0.47 mm OD Cone Tipped Needle PK6	E	
80390	701ASN 10 µL SYR-HP 23s (6/PK)	002814	10 µL Fixed Needle Agilent Syringe with 4.2 cm 0.63 mm OD Cone Tipped Needle PK6	E	
80391	701ASN 6/PK (23-26/1.71 "/HP)	002822	10 µL Fixed Needle Agilent Syringe with 4.2 cm 0.63/0.47 mm OD Cone Tipped Dual Gauge Needle PK6	E	
80393	701ASN SYR (23-26/1.71 "/HP)	002821	10 µL Fixed Needle Agilent Syringe with 4.2 cm 0.63/0.47 mm OD Cone Tipped Dual Gauge Needle	E	
80398	701ASN 10 µL SYR (23s/1.71 "/2)	002810	10 µL Fixed Needle Agilent Syringe with 4.2 cm 0.63 mm OD Cone Tipped Needle	O	Cone Tipped Needle
80399	701ASN 10 µL SYR (26s/1.71 "/2)	002800	10 µL Fixed Needle Agilent Syringe with 4.2 cm 0.47 mm OD Cone Tipped Needle	O	Cone Tipped Needle
80400	702N 25 µL SYR (22s/2 "/2)	003000	25 µL Fixed Needle Syringe with 5 cm 0.5 mm OD Bevel Tipped Needle	E	
80404	702NCH 25 µL SYR (22s/2 "/2)	003000 + 031930	25 µL Fixed Needle Syringe with 5 cm 0.5 mm OD Bevel Tipped Needle and Repeating Adaptor	E	
80407	702NWG 25 µL SYR (22s/2 "/2)	003000 + 031930	25 µL Fixed Needle Syringe with 5 cm 0.5 mm OD Bevel Tipped Needle and Repeating Adaptor	E	
80419	702SN 25 µL SYR (22/2 "/3)	003300	25 µL Fixed Needle Syringe with 5.1 cm 0.72 mm OD LC Needle	E	
80430	702RN 25 µL SYR (22s/2 "/2)	003050	25 µL Removable Needle Syringe with 5 cm 0.5 mm OD Bevel Tipped Needle	E	
80439	702NPT5 25 µL SYR (22s/2 "/5)	003050 + 038410	25 µL Removable Needle Syringe with 5 cm Side Hole Dome Tipped Needle	O	RN, 25 g Needle
80465	702SNR 25 µL SYR (22s/2 "/3)	003300	25 µL Fixed Needle Syringe with 5.1 cm 0.72 mm OD LC Needle	E	
80500	705N 50 µL SYR (22s/2 "/2)	004000	50 µL Fixed Needle Syringe with 5 cm 0.5 mm OD Bevel Tipped Needle	E	

Syringes | Cross Reference Hamilton Continued

Hamilton Part Number	Part Description and Detail	SGE Part Number	Part Description and Detail	Equivalent or Option	Variation
80501	705LT 50 µL SYR	004229	50 µL Fixed Luer Tip Syringe with GT Plunger	E	
80505	705NCH 50 µL SYR (22s/2 °/2)	004000 + 031930	50 µL Fixed Needle Syringe with 5 cm 0.5 mm OD Bevel Tipped Needle and Repeating Adaptor	E	
80521	705SN 50 µL SYR (22/2 °/3)	004300	50 µL Fixed Needle Syringe with 5.1 cm 0.72 mm OD LC Needle	E	
80530	705RN 50 µL SYR (22s/2 °/2)	004050	50 µL Removable Needle Syringe with 5 cm 0.5 mm OD Bevel Tipped Needle	E	
80539	705NPT5 50 µL SYR (22s/2 °/5)	004050 + 038410	50 µL Removable Needle Syringe with 5 cm Side Hole Dome Tipped Needle	O	RN, 25 g Needle
80565	705SNR 50 µL SYR (22s/2 °/3)	004300	50 µL Fixed Needle Syringe with 5.1 cm 0.72 mm OD LC Needle	E	
80600	710N 100 µL SYR (22s/2 °/2)	005000	100 µL Fixed Needle Syringe with 5 cm 0.5 mm OD Bevel Tipped Needle	E	
80601	710LT 100 µL SYR	005229	100 µL Fixed Luer Tip Syringe with GT Plunger	E	
80605	710NCH 100 µL SYR (22s/2 °/2)	005000 + 031930	100 µL Fixed Needle Syringe with 5 cm 0.5 mm OD Bevel Tipped Needle and Repeating Adaptor	E	
80621	710SN 100 µL SYR (22/2 °/3)	005300	100 µL Fixed Needle Syringe with 5.1 cm 0.72 mm OD LC Needle	E	
80630	710RN 100 µL SYR (22s/2 °/2)	005050	100 µL Removable Needle Syringe with 5 cm 0.5 mm OD Bevel Tipped Needle	E	
80639	710NPT5 100 µL SYR (22s/2 °/5)	005050 + 038410	100 µL Removable Needle Syringe with 5 cm Side Hole Dome Tipped Needle	O	RN, 25 g Needle
80665	710SNR 100 µL SYR (22s/2 °/3)	005300	100 µL Fixed Needle Syringe with 5.1 cm 0.72 mm OD LC Needle	E	
80700	725N 250 µL SYR (22S/2 °/2)	006000	250 µL Fixed Needle Syringe with 5 cm 0.5 mm OD Bevel Tipped Needle	E	
80701	725LT 250 µL SYR	006229	250 µL Fixed Luer Tip Syringe with GT Plunger	E	
80730	725RN 250 µL SYR (22s/2 °/2)	006050	250 µL Removable Needle Syringe with 5 cm 0.5 mm OD Bevel Tipped Needle	E	
80739	725N 250 µL SYR (22S/2 °/5)	006050 + 038410	250 µL Removable Needle Syringe with 5 cm Side Hole Dome Tipped Needle	O	RN, 25 g Needle
80765	725NR 250 µL (22/2 °/3)	006300	250 µL Fixed Needle Syringe with 5.1 cm 0.72 mm OD LC Needle	E	
80800	750N 500 µL SYR (22/2 °/2)	007000	500 µL Fixed Needle Syringe with 5 cm 0.5 mm OD Bevel Tipped Needle	E	
80801	750LT 500 µL SYR	007229	500 µL Fixed Luer Tip Syringe with GT Plunger	E	
80830	750RN 500 µL SYR (22/2 °/2)	007050	500 µL Removable Needle Syringe with 5 cm 0.5 mm OD Bevel Tipped Needle	E	
80839	750N 500 µL SYR (22/2 °/5)	007050 + 038410	500 µL Removable Needle Syringe with 5 cm Side Hole Dome Tipped Needle	O	RN, 25 g Needle
80865	750N 500 µL SYR (22/2 °/3)	007300	500 µL Fixed Needle Syringe with & 5.1 cm 0.72 mm OD LC Needle	E	
80900	1705N 50 µL SYR (22s/2 °/2)	004200	50 µL Fixed Needle Syringe with GT Plunger & 5 cm 0.5 mm OD Bevel Tipped Needle	E	
80901	1705LT 50 µL SYR	004229	50 µL Fixed Luer Tip Syringe with GT Plunger	E	
80920	1705TLL 50 µL SYR	004230	50 µL Fixed Luer Lock Syringe with GT Plunger	E	
80922	1705TLLX 50 µL SYR	004232	50 µL Fixed Luer Lock Syringe with GT Plunger & Plunger Stop	E	
80927	1705TLL 50 µL SYR W/SLOTS	004230	50 µL Fixed Luer Lock Syringe with GT Plunger	E	
80930	1705RN 50 µL SYR (22s/2 °/2)	004250	50 µL Removable Needle Syringe with GT Plunger & 5 cm 0.5 mm OD Bevel Tipped Needle	E	
80938	1705RNW 50 µL SYR(25s/1.97 °/3)	004250 + 038260	50 µL Removable Needle Syringe with GT Plunger & Waters LC Tipped Needle	E	
80939	1705NPT5 50 µL SYR (22s/2 °/5)	004250 + 038410	50 µL Removable Needle Syringe with GT Plunger & 5 cm Side Hole Dome Tipped Needle	O	RN, 25 g Needle
80956	1705SL 50 µL SYR (22s/2 °/2)L	004279	50 µL Syringe with Removable Needle Valve & GT Plunger	E	
80962	1705CX 50 µL SYR W/STOP	004995	50 µL Syringe with GT Plunger and 1/4-28 UNF Termination	E	
80965	1705RNR 50 µL SYR (22s/2 °/3)	004312	50 µL Removable Needle Syringe with GT Plunger & 5.1 cm 0.72 mm OD LC Needle	E	
80975	1705N 50 µL SYR (22s/2 °/3)	004312	50 µL Removable Needle Syringe with GT Plunger & 5.1 cm 0.72 mm OD LC Needle	O	RN
80985	1705N 50 µL SYR (22/2 °/3)	004312	50 µL Removable Needle Syringe with GT Plunger & 5.1 cm 0.72 mm OD LC Needle	O	RN
81000	1710N 100 µL SYR (22s/2 °/2)	005200	100 µL Fixed Needle Syringe with GT Plunger & 5 cm 0.5 mm OD Bevel Tipped Needle	O	25 g Needle
81001	1710LT 100 µL SYR	005229	100 µL Fixed Luer Tip Syringe with GT Plunger	E	
81020	1710TLL 100 µL SYR	005230	100 µL Fixed Luer Lock Syringe with GT Plunger	E	
81022	1710TLLX 100 µL SYR	005232	100 µL Fixed Luer Lock Syringe with GT Plunger & Plunger Stop	E	
81027	1710TLL 100 µL SYR W/SLOTS	005230	100 µL Fixed Luer Lock Syringe with GT Plunger	E	
81030	1710RN 100 µL SYR (22s/2 °/2)	005250	100 µL Removable Needle Syringe with GT Plunger & 5 cm 0.5 mm OD Bevel Tipped Needle	E	
81038	1710RNW 100 µL SYR(25s/1.97 °/3)	005250 + 038260	100 µL Removable Needle Syringe with GT Plunger & Waters LC Tipped Needle	E	
81039	1710NPT5 100 µL SYR (22s/2 °/5)	005250 + 038410	100 µL Removable Needle Syringe with GT Plunger & 5 cm Side Hole Dome Tipped Needle	O	RN, 25 g Needle

Syringes | Cross Reference Hamilton Continued

Hamilton Part Number	Part Description and Detail	SGE Part Number	Part Description and Detail	Equivalent or Option	Variation
81056	1710SL 100 µL SYR (22s/2 *1/2)L	005279	100 µL Syringe with Removable Needle Valve & GT Plunger	E	
81060	1710C 100 µL SYR	005990	100 µL Syringe with GT Plunger and 1/4-28 UNF Termination	E	
81062	1710CX 100 µL SYR W/STOP	005990	100 µL Syringe with GT Plunger and 1/4-28 UNF Termination	E	
81065	1710RNR 100 µL SYR (22s/2 *1/3)	005312	100 µL Removable Needle Syringe with GT Plunger & 5.1 cm 0.72 mm OD LC Needle	E	
81075	1710N 100 µL SYR (22s/2 *1/3)	005312	100 µL Removable Needle Syringe with GT Plunger & 5.1 cm 0.72 mm OD LC Needle	O	RN
81085	1710N 100 µL SYR (22/2 *1/3)	005312	100 µL Removable Needle Syringe with GT Plunger & 5.1 cm 0.72 mm OD LC Needle	O	RN
81100	1725LTN 250 µL SYR (22s/2 *1/2)	006200	250 µL Fixed Needle Syringe with GT Plunger & 5 cm 0.5 mm OD Bevel Tipped Needle	O	Not LT
81101	1725LT 250 µL SYR	006229	250 µL Fixed Luer Tip Syringe with GT Plunger	E	
81120	1725TLL 250 µL SYR	006230	250 µL Fixed Luer Lock Syringe with GT Plunger	E	
81122	1725TLLX 250 µL SYR	006232	250 µL Fixed Luer Lock Syringe with GT Plunger & Plunger Stop	E	
81127	1725TLL 250 µL SYR W/SLOTS	006230	250 µL Fixed Luer Lock Syringe with GT Plunger	E	
81130	1725RN 250 µL SYR (22s/2 *1/2)	006250	250 µL Removable Needle Syringe with GT Plunger & 5 cm 0.5 mm OD Bevel Tipped Needle	E	
81138	1725RNW 250 µL SYR(25s/1.97 *1/3)	006250 + 038260	250 µL Removable Needle Syringe with GT Plunger & Waters LC Tipped Needle	O	RN
81139	1725LTN 250 µL SYR (22s/2 *1/5)	006250 + 038410	250 µL Removable Needle Syringe with GT Plunger & 5 cm Side Hole Dome Tipped Needle	O	
81156	1725SL 250 µL SYR (22s/2 *1/2)L	006279	250 µL Syringe with Removable Needle Valve & GT Plunger	E	
81162	1725CX 250 µL SYR W/STOP	006995	250 µL Syringe with GT Plunger and 1/4-28 UNF Termination	E	
81165	1725RNR 250 µL SYR (22/2 *1/3)	006312	250 µL Removable Needle Syringe with GT Plunger & 5.1 cm 0.72 mm OD LC Needle	E	
81175	1725LTN 250 µL SYR (22s/2 *1/3)	006312	250 µL Removable Needle Syringe with GT Plunger & 5.1 cm 0.72 mm OD LC Needle	O	RN
81185	1725LTN 250 µL SYR (22/2 *1/3)	006312	250 µL Removable Needle Syringe with GT Plunger & 5.1 cm 0.72 mm OD LC Needle	O	RN
81201	1750LT 500 µL SYR	007229	500 µL Fixed Luer Tip Syringe with GT Plunger	E	
81216	1750LTN 500 µL SYR (22/2 *1/3)	007312	500 µL Removable Needle Syringe with GT Plunger & 5.1 cm 0.72 mm OD LC Needle	O	RN
81217	1750LTN 500 µL SYR (22/2 *1/2)	007200	500 µL Fixed Needle Syringe with GT Plunger & 5 cm 0.5 mm OD Bevel Tipped Needle	E	Not LT
81220	1750TLL 500 µL SYR	007230	500 µL Fixed Luer Lock Syringe with GT Plunger	E	
81222	1750TLLX 500 µL SYR	007232	500 µL Fixed Luer Lock Syringe with GT Plunger & Plunger Stop	E	
81227	1750TLL 500 µL SYR W/SLOTS	007230	500 µL Fixed Luer Lock Syringe with GT Plunger	E	
81230	1750RN 500 µL SYR (22/2 *1/2)	007250	500 µL Removable Needle Syringe with GT Plunger & 5 cm 0.5 mm OD Bevel Tipped Needle	E	
81243	1750LTNPT5 500 µL SYR (22/2 *1/5)	007250 + 038410	500 µL Removable Needle Syringe with GT Plunger & 5 cm Side Hole Dome Tipped Needle	O	Not LT, 25 g Needle
812560	1750SL	007279	500 µL Syringe with Removable Needle Valve & GT Plunger	E	23 g Needle
81262	1750CX 500 µL SYR W/STOP	007995	500 µL Syringe with GT Plunger and 1/4-28 UNF Termination	E	
81265	1750RNR 500 µL SYR (22/2 *1/3)	007312	500 µL Removable Needle Syringe with GT Plunger & 5.1 cm 0.72 mm OD LC Needle	E	
81301	1001LT 1.0 mL SYR	008020	1 mL Fixed Luer Tip Syringe with GT Plunger	E	
81316	1001LTN 1.0 mL SYR (22/2 *1/3)	008105	1 mL Removable Needle Syringe with GT Plunger & 5.1 cm 0.72 mm OD LC Needle	O	RN
81317	1001LTN 1.0 mL SYR (22/2 *1/2)	008102	1 mL Fixed Needle Syringe with GT Plunger & 5 cm 0.72 mm OD Bevel Tipped Needle	O	Not LT
81318	1001LTNCH 1.0 mL SYR (22/2 *1/2)	008102	1 mL Fixed Needle Syringe with GT Plunger & 5 cm 0.72 mm OD Bevel Tipped Needle	O	WO Adaptor
81320	1001TLL 1.0 mL SYR	008025	1 mL Fixed Luer Lock Syringe with GT Plunger	E	
81324	1001TLLCH 1.0 mL SYR	008025	1 mL Fixed Luer Lock Syringe with GT Plunger	O	WO Adaptor
81327	1001TLL 1.0 mL SYR W/SLOTS	008025	1 mL Fixed Luer Lock Syringe with GT Plunger	E	
81330	1001RN 1.0 mL SYR (22/2 *1/2)	008100	1 mL Removable Needle Syringe with GT Plunger & 5 cm 0.63 mm OD Bevel Tipped Needle	E	
81343	1001LTNPT5 1.0 mL SYR (22/2 *1/5)	008100 + 039120	1 mL Removable Needle Syringe with GT Plunger & 5 cm Side Hole Dome Tipped Needle	O	Not LT, 23 g Needle
81356	1001SL 1.0 mL SYR (22/2 *1/2)L	008110	1 mL Syringe with Removable Needle Valve & GT Plunger	E	
81360	1001C 1.0 mL SYR	008185	1 mL Fixed Needle CTC RTC & Thermo RSH Head Space Syringe with Energized GT Plunger and 6.5 cm 0.63 mm OD Side-hole Needle	E	
81365	1001RNR 1.0 mL SYR (22/2 *1/3)	008105	1 mL Removable Needle Syringe with GT Plunger & 5.1 cm 0.72 mm OD LC Needle	E	
81401	1002LT 2.5 mL SYR	008420	1.0 mL V6 Dispenser Syringe	E	
81403	1002LTCH 2.5 mL SYR	008020	1 mL Fixed Luer Tip Syringe with GT Plunger	O	WO Adaptor
81416	1002LTN 2.5 mL SYR (22/2 *1/3)	008505	2.5 mL Removable Needle Syringe with GT Plunger & 5.1 cm 0.72 mm OD LC Needle	O	RN
81417	1002LTN 2.5 mL SYR (22/2 *1/2)	008502	2.5 mL Fixed Needle Syringe with GT Plunger & 5 cm 0.72 mm OD Bevel Tipped Needle	E	
81418	1002LTNCH 2.5 mL SYR (22/2 *1/2)	008502	2.5 mL Fixed Needle Syringe with GT Plunger & 5 cm 0.72 mm OD Bevel Tipped Needle	O	WO Adaptor
81420	1002TLL 2.5 mL SYR	008425	2.5 mL Fixed Luer Tip Syringe with GT Plunger	E	

Syringes | Cross Reference Hamilton Continued

Hamilton Part Number	Part Description and Detail	SGE Part Number	Part Description and Detail	Equivalent or Option	Variation
81424	1002TLLCH 2.5 mL SYR	008425	2.5 mL Fixed Luer Lock Syringe with GT Plunger	O	WO Adaptor
81427	1002TLL 2.5 mL SYR W/SLOTS	008425	2.5 mL Fixed Luer Lock Syringe with GT Plunger	E	
81430	1002RN 2.5 mL SYR (22/2 °/2)	008500	2.5 mL Removable Needle Syringe with GT Plunger & 5 cm 0.63 mm OD Bevel Tipped Needle	E	
81443	1002LTNP5 2.5 mL SYR (22/2 °/5)	008500 + 039120	2.5 mL Removable Needle Syringe with GT Plunger & 5 cm Side Hole Dome Tipped Needle	O	Not LT, 23 g Needle
81456	1002SL 2.5 mL SYR (22/2 °/2)L	008510	2.5 mL Syringe with Removable Needle Valve & GT Plunger	E	
81460	1002C 2.5 mL SYR	008687	2.5 mL Syringe with GT Plunger and 1/4-28 UNF Termination	E	
81501	1005LT 5.0 mL SYR	008760	5 mL Removable Luer Lock Syringe with GT Plunger	O	LL Not LT
81516	1005LTN 5 mL SYR (22/2 °/3)	008700 + 0315233	5 mL Removable Needle Syringe with GT Plunger & LC Needle	O	RN
81517	1005LTN 5.0 mL SYR (22/2 °/2)	008700	5 mL Removable Needle Syringe with GT Plunger & 5 cm 0.63 mm OD Bevel Tipped Needle	O	RN
81518	1005LTNCH 5.0 mL SYR (22/2 °/2)	008762	5 mL Fixed Luer Lock Syringe with GT Plunger	O	LL Not LT. WO Adaptor
81520	1005TLL 5.0 mL SYR	008762	5 mL Fixed Luer Lock Syringe with GT Plunger	E	
81524	1005TLLCH 5.0 mL SYR	008762	5 mL Fixed Luer Lock Syringe with GT Plunger	O	WO Adaptor
81527	1005TLL 5 mL SYR W/SLOTS	008762	5 mL Fixed Luer Lock Syringe with GT Plunger	E	
81530	1005RN 5.0 mL SYR (22/2 °/2)	008700	5 mL Removable Needle Syringe with GT Plunger & 5 cm 0.63 mm OD Bevel Tipped Needle	E	
81560	1005C 5.0 mL SYR	008787	5 mL Syringe with GT Plunger and 1/4-28 UNF Termination	E	
81601	1010LT 10.0 mL SYR	008962	10 mL Fixed Luer Lock Syringe with GT Plunger	O	LL Not LT
81610	1010W 10.0 mL (WATERS) SYR	008962	10 mL Fixed Luer Lock Syringe with GT Plunger	E	
81616	1010LTN 10 mL SYR (22/2 °/3)	008900 + 0315233	10 mL Removable Needle Syringe with GT Plunger & LC Needle	O	RN
81617	1010LTN 10.0 mL SYR (22/2 °/2)	008900	10 mL Removable Needle Syringe with GT Plunger & 5 cm 0.63 mm OD Bevel Tipped Needle	O	RN
81618	1010LTNCH 10.0 mL SYR (22/2 °/2)	008962	10 mL Fixed Luer Lock Syringe with GT Plunger	O	LL Not LT. WO Adaptor
81620	1010TLL 10.0 mL SYR	008962	10 mL Fixed Luer Lock Syringe with GT Plunger	E	
81624	1010TLLCH 10.0 mL SYR	008962	10 mL Fixed Luer Lock Syringe with GT Plunger	O	WO Adaptor
81627	1010TLL 10 mL SYR W/SLOTS	008962	10 mL Fixed Luer Lock Syringe with GT Plunger	E	
81630	1010RN 10.0 mL SYR (22/2 °/2)	008900	10 mL Removable Needle Syringe with GT Plunger & 5 cm 0.63 mm OD Bevel Tipped Needle	E	
81660	1010C 10.0 mL SYR	008987	10 mL Syringe with GT Plunger and 1/4-28 UNF Termination	E	
82017	1001.25LTN 1.25 mL SYR (22/2 °/2)	009462	25 mL Removable Luer Lock Syringe with GT Plunger	O	LL. Select Needle Separately
82520	1025TLL 25.0 mL SYR	009463	25 mL Fixed Luer Lock Syringe with GT Plunger	E	
82525	1025TLL W/O FL 25 mL SYR W/ SLOT	009463	25 mL Fixed Luer Lock Syringe with GT Plunger	O	WO Adaptor
82527	1025TLL 25 mL SYR W/SLOTS	009463	25 mL Fixed Luer Lock Syringe with GT Plunger	E	
84850	85N 5 µL SYR (26s/2 °/2)	001400	5 µL Fixed Needle Guided Plunger Syringe with 5 cm 0.47 mm OD Bevel Tipped Needle	O	
84851	85RN 5 µL SYR (26s/2 °/2)	001450	5 µL Removable Needle Guided Plunger Syringe with 5 cm 0.47 mm OD Bevel Tipped Needle	O	
84852	801N 10 µL SYR (26s/2 °/2)	002400	10 µL Fixed Needle Guided Plunger Syringe with 5 cm 0.47 mm OD Bevel Tipped Needle	O	
84853	801RN 10 µL SYR (26s/2 °/2)	002450	10 µL Removable Needle Guided Plunger Syringe with 5 cm 0.47 mm OD Bevel Tipped Needle	O	
85020	1050TLL 50.0 mL SYR	009660	50 mL Removable Luer Lock Syringe with GT Plunger	E	
85027	1050TLL 50 mL SYR W/SLOTS	009660	50 mL Removable Luer Lock Syringe with GT Plunger	E	
86020	1100TLL 100.0 mL SYR	009760	100 mL Removable Luer Lock Syringe with GT Plunger	E	
86204	7101KHCH 1 µL SYR (22/2.75 °/3)	000553	1.0 µL NanoVolume Syringe with 7 cm 0.63 mm OD Cone Tipped Needle & Repeating Adaptor	O	Cone Tip
86207	7101KHWG 1 µL SYR (22/2.75 °/3)	000553	1.0 µL NanoVolume Syringe with 7 cm 0.63 mm OD Cone Tipped Needle & Repeating Adaptor	O	Cone Tip
86211	7101KH 1 µL SYR (22s/2.75 °/2)	000505	1.0 µL NanoVolume Syringe with 7 cm 0.63 mm OD Cone Tipped Needle	O	23 g Needle
86250	7000.5KH 0.5 µL SYR (25/2.75 °/3)	000310	0.5 µL NanoVolume Syringe with 7 cm 0.63 mm OD Cone Tipped Needle	O	Cone Tip
86252	7000.5KHCH .5 µL SYR(25/2.75/3)	000355	0.5 µL NanoVolume Syringe with 7 cm 0.63 mm OD Cone Tipped Needle & Repeating Adaptor	O	Cone Tip
86254	7000.5KHWG .5 µL SYR(25/2.75/3)	000355	0.5 µL NanoVolume Syringe with 7 cm 0.63 mm OD Cone Tipped Needle & Repeating Adaptor	O	Cone Tip
86259	7000.5KH 0.5 µL SYR (25/2.75 °/2)	000311	0.5 µL NanoVolume Syringe with 7 cm 0.63 mm OD Bevel Tipped Needle	O	23 g Needle
86274	7000.5ASRN (26/1.71 °/HP)	000400	0.5 µL NanoVolume Agilent Syringe with 4.2 cm 0.47 mm OD Cone Tipped Needle	E	
86276	7000.5ASRN (23/1.71 °/HP)	000410	0.5 µL NanoVolume Agilent Syringe with 4.2 cm 0.63 mm OD Cone Tipped Needle	E	
86311	S0500 0.5L SYR (TLL)	009910	500 mL Jumbo Luer Lock Syringe	E	
86312	S1000 1.0L SYR (TLL)	009920	1000 mL Jumbo Luer Lock Syringe	E	
86313	S1500 1.5L SYR (TLL)	009930	2000 mL Jumbo Luer Lock Syringe	O	2 L Instead of 1.5 L
86314	S2000 2.0L SYR (TLL)	009930	2000 mL Jumbo Luer Lock Syringe	E	



## Syringes | Cross Reference Hamilton Continued

Hamilton Part Number	Part Description and Detail	SGE Part Number	Part Description and Detail	Equivalent or Option	Variation
86326	1025SL 25 mL SYR (22/2 "/2)L	009472	25 mL Syringe with Removable Luer Lock Valve & GT Plunger	O	LL. Select Needle Separately
863260	1025SL	009472	25 mL Syringe with Removable Luer Lock Valve & GT Plunger	O	Select Needle Separately
86336	1050SL 50 mL SYR (22/2 "/2)L	009670	50 mL Syringe with Removable Luer Lock Valve & GT Plunger	O	LL. Select Needle Separately
863360	1050SL	009670	50 mL Syringe with Removable Luer Lock Valve & GT Plunger	O	Select Needle Separately
86346	1100SL 100 mL SYR (22/2 "/2)L	009770	100 mL Syringe with Removable Luer Lock Valve & GT Plunger	O	LL. Select Needle Separately
87402	701RNFS 10 µL SYR(.17mm/10cm/3)	002050 + 037610	10 µL Removable Needle Syringe with 10 cm 0.17 mm OD Needle	E	
87404	1701RNFS 10 µL SYR(.17mm/10cm/3)	002250 + 037610	10 µL Removable Needle Syringe with GT Plunger & 5 cm 0.47 mm OD Bevel Tipped Needle	E	
87900	75N 5 µL SYR (26s/2 "/2)	001000	5 µL Fixed Needle Syringe with 5 cm 0.47 mm OD Bevel Tipped Needle	E	
87919	75N 5 µL SYR (26s/2 "/3)	001301	5 µL Fixed Needle Syringe with 5.1 cm 0.72 mm OD LC Needle	E	
87930	75RN 5.0 µL SYR (26s/2 "/2)	001050	5 µL Removable Needle Syringe with 5 cm 0.47 mm OD Bevel Tipped Needle	E	
87943	65RNR 5.0 µL SYR (22s/2 "/3)	001450	5 µL Removable Needle Guided Plunger Syringe with 5 cm 0.47 mm OD Bevel Tipped Needle	E	
87957	75ASRN 5 µL SYR (23s/1.71 "/HP)	001810	5 µL Fixed Needle Agilent Syringe with 4.2 cm 0.63 mm OD Cone Tipped Needle	O	FN
87958	75ASRN 5 µL SYR (26s/1.71 "/HP)	001800	5 µL Fixed Needle Agilent Syringe with 4.2 cm 0.47 mm OD Cone Tipped Needle	O	FN
87959	75ASRN SYR (23S/26S/1.71 "/HP)	001821	5 µL Fixed Needle Agilent Syringe with 4.2 cm 0.63/0.47 mm OD Cone Tipped Dual Gauge Needle	O	FN
87987	75ASN 5 µL SYR (23s/1.71 "/HP)	001810	5 µL Fixed Needle Agilent Syringe with 4.2 cm 0.63 mm OD Cone Tipped Needle	E	
87988	75ASN 5 µL SYR (26s/1.71 "/HP)	001800	5 µL Fixed Needle Agilent Syringe with 4.2 cm 0.47 mm OD Cone Tipped Needle	E	
87989	75ASN 5 µL SYR(26s/1.71 "/HP)6PK	001804	5 µL Fixed Needle Agilent Syringe with 4.2 cm 0.47 mm OD Cone Tipped Needle PK6	E	
87990	75ASN 5 µL SYR(23s/1.71 "/HP)6PK	001814	5 µL Fixed Needle Agilent Syringe with 4.2 cm 0.63 mm OD Cone Tipped Needle PK6	E	
87991	75ASN 5 µL SYR (23s/1.71 "/2)	001810	5 µL Fixed Needle Agilent Syringe with 4.2 cm 0.63 mm OD Cone Tipped Needle	O	Cone Tipped Needle
87992	75ASN 5 µL SYR (26s/1.71 "/2)	001800	5 µL Fixed Needle Agilent Syringe with 4.2 cm 0.47 mm OD Cone Tipped Needle	O	Cone Tipped Needle
87993	75ASN 5 µL SYR (23-26/1.71 "/HP)	001821	5 µL Fixed Needle Agilent Syringe with 4.2 cm 0.63/0.47 mm OD Cone Tipped Dual Gauge Needle	E	
87994	75ASN 5 µL 6/PK(23-26/1.71 "/HP)	001822	5 µL Fixed Needle Agilent Syringe with 4.2 cm 0.63/0.47 mm OD Cone Tipped Dual Gauge Needle PK6	E	
88000	7105KH 5.0 µL SYR (24/2.75 "/3)	000802	5.0 µL NanoVolume Syringe with 7 cm 0.63 mm OD Cone Tipped Needle	E	
88004	7105KHCH 5.0 µL SYR (24/2.75 "/3)	000852	5.0 µL NanoVolume Syringe with 7 cm 0.63 mm OD Cone Tipped Needle & Repeating Adaptor	E	
88007	7105KHWG 5.0 µL SYR (24/2.75 "/3)	000852	5.0 µL NanoVolume Syringe with 7 cm 0.63 mm OD Cone Tipped Needle & Repeating Adaptor	E	
88011	7105KH 5.0 µL SYR (24/2.75 "/2)	000803	5.0 µL NanoVolume Syringe with 7 cm 0.63 mm OD Bevel Tipped Needle	E	
88035	75ASN/PE SYR 5 µL 0.63 mm OD	001954	5 µL Fixed Needle PerkinElmer Syringe with 7 cm 0.63 mm OD Cone Tipped Needle	E	
88040	75ASN/PE SYR 5 µL 0.47 mm OD	001953	5 µL Fixed Needle PerkinElmer Syringe with 7 cm 0.47 mm OD Cone Tipped Needle	E	

Every effort has been made to ensure the SGE branded Equivalents and similar close Options suggested here are suitable alternative products, however the appropriateness for individual applications must remain the responsibility of the user.

For more information visit [www.sge.com](http://www.sge.com) or contact [techsupport@sge.com](mailto:techsupport@sge.com).







# Injection Port | Inlet Liner ConnectTite

## Spot the Difference in the SGE Lineup!

The SGE inlet liner range aims to make it simple for all gas chromatographers to select the correct liner.

Choosing the right inlet liner and injection parameters can increase peak areas and reduce detection limits by up to 300 %.

- Easy to choose - color coded by geometry to simplify your selection.
- Easy to use - contains o-rings so you're ready to go.
- Confidence in your analysis - certified deactivation.

### Features and Benefits

- ConnectTite liners facilitate maximum transfer of sample to the GC column and inhibit sample degradation by reducing contact with hot metal components inside the inlet.
- A hole in the liner body maintains gas flows in systems equipped with electronic pressure control.
- ConnectTite liners with a hole near the bottom are ideal for analyses where early eluting compounds may be affected by a tailing solvent peak.
- ConnectTite liners with a hole at the top improve analyses of aqueous samples.
- ConnectTite liners with a hole at the top are also ideal for analyses where compounds of interest elute away from the solvent peak.



Color coded orange.

### Recommended Applications

ConnectTite liners are recommended for the following sample or injection modes:

- Trace level analysis.
- Direct injection.
- Active compounds.
- Aqueous samples.

### Product Specifications

ConnectTite available for Agilent, PerkinElmer, Shimadzu 2010, Thermo Scientific, and Bruker/Varian 1075/1077 injectors.

Injector	Length (mm)	OD (mm)	ID (mm)
Agilent	78.5	6.3	4
Bruker/Varian	54	4.6	0.5
Bruker/Varian	54	4.6	0.8
Bruker/Varian	72	6.3	4
PerkinElmer	92	6.2	4
Shimadzu	95	5	2.6
Shimadzu	95	5	3.4
Thermo	105	8	5
Thermo	78.5	6.3	4

For more information about this product visit [www.sge.com](http://www.sge.com) or contact [techsupport@sge.com](mailto:techsupport@sge.com).

## Injection Port | Inlet Liner Connectite

### Spot the Difference in the SGE Lineup!

Part Number	Part Description and Detail
<b>Agilent</b>	
092324	Connectite Agilent Inlet Liners Length 78.5 mm PK5
092325	Connectite Agilent Inlet Liners with Top Hole, Length 78.5 mm PK5
092326	Connectite Agilent Inlet Liners with Bottom Hole, Length 78.5 mm PK5
<b>Bruker/Varian</b>	
09233901	Connectite Bruker/Varian 1075/1077 Inlet Liner Length 72 mm PK1
092339	Connectite Bruker/Varian 1075/1077 Inlet Liners Length 72 mm PK5
09234001	Connectite Bruker/Varian 1075/1077 Inlet Liner with Top Hole, Length 72 mm PK1
092340	Connectite Bruker/Varian 1075/1077 Inlet Liners with Top Hole, Length 72 mm PK5
09234101	Connectite Bruker/Varian 1075/1077 Inlet Liner with Bottom Hole, Length 72 mm PK1
092341	Connectite Bruker/Varian 1075/1077 Inlet Liners with Bottom Hole, Length 72 mm PK5
09203001	Connectite Bruker/Varian 1093/1094 Inlet Liner 0.8 mm ID, Length 54 mm (Rest 0.25 mm) PK1
092030	Connectite Bruker/Varian 1093/1094 Inlet Liners 0.8 mm ID, Length 54 mm (Rest 0.25 mm) PK5
09203401	Connectite Bruker/Varian 1093/1094 Inlet Liner 0.8 mm ID, Length 54 mm (Rest 0.5 mm) PK1
092034	Connectite Bruker/Varian 1093/1094 Inlet Liners 0.8 mm ID, Length 54 mm (Rest 0.5 mm) PK5
<b>PerkinElmer</b>	
092344	Connectite PerkinElmer Inlet Liners Length 92 mm PK5
092345	Connectite PerkinElmer Inlet Liners with Top Hole, Length 92 mm PK5
09234601	Connectite PerkinElmer Inlet Liner with Bottom Hole, Length 92 mm PK1
092346	Connectite PerkinElmer Inlet Liners with Bottom Hole, Length 92 mm PK5
<b>Shimadzu</b>	
09232901	Connectite Shimadzu Inlet Liner Length 95 mm PK1
092329	Connectite Shimadzu Inlet Liners Length 95 mm PK5
09233001	Connectite Shimadzu Inlet Liner with Top Hole, Length 95 mm PK1
092330	Connectite Shimadzu Inlet Liners with Top Hole, Length 95 mm PK5
09233101	Connectite Shimadzu Inlet Liner with Bottom Hole, Length 95 mm PK1
092331	Connectite Shimadzu Inlet Liners with Bottom Hole, Length 95 mm PK5
<b>Thermo Scientific</b>	
09233401	Connectite Thermo Scientific Inlet Liner Length 105 mm PK1
092334	Connectite Thermo Scientific Inlet Liners Length 105 mm PK5
09233501	Connectite Thermo Scientific Inlet Liner with Top Hole, Length 105 mm PK1
092335	Connectite Thermo Scientific Inlet Liners with Top Hole, Length 105 mm PK5
09233601	Connectite Thermo Scientific Inlet Liner with Bottom Hole, Length 105 mm PK1
092336	Connectite Thermo Scientific Inlet Liners with Bottom Hole, Length 105 mm PK5

Note - Bruker/Varian 1077 injectors and Thermo Trace 1300 series are using 78.5 mm "Agilent" Liners

For more information about this product visit [www.sge.com](http://www.sge.com) or contact [techsupport@sge.com](mailto:techsupport@sge.com).

## Injection Port | Inlet Liner Double Taper

### Spot the Difference in the SGE Lineup!

The SGE inlet liner range aims to make it simple for all gas chromatographers to select the correct liner.

Choosing the right inlet liner and injection parameters can increase peak areas and reduce detection limits by up to 300 %.

- Easy to choose - color coded by geometry to simplify your selection.
- Easy to use - contains o-rings so you're ready to go.
- Confidence in your analysis - certified deactivation.

#### Features and Benefits

- Bottom taper minimizes contact with metal parts of the inlet and focuses sample onto the head of the column.
- Top taper aids in minimizing sample flashback.

#### Recommended Applications

Double Taper liners are recommended for the following sample or injection modes:

- Trace level analyses.
- Splitless.
- Low boiling point compounds.
- Active compounds.



Color coded yellow.

#### Product Specifications

Double taper available for Agilent, Thermo Scientific, and Varian/Bruker 1177 & 1078/1079 injectors.

Injector	Length (mm)	OD (mm)	ID (mm)
Agilent	78.5	6.3	4
Thermo	105	8	5
Thermo	78.5	6.3	4
Varian/Bruker	78.5	6.3	4
Varian/Bruker	54	5	3.4

For more information about this product visit [www.sge.com](http://www.sge.com) or contact [techsupport@sge.com](mailto:techsupport@sge.com).

## Injection Port | Inlet Liner Double Taper

Spot the Difference in the SGE Lineup!

Part Number	Part Description and Detail
<b>Agilent</b>	
09201801	Agilent Inlet Liner 4 mm ID Double Taper, Length 78.5 mm PK1
092018	Agilent Inlet Liners 4 mm ID Double Taper, Length 78.5 mm PK5
092230	Agilent Inlet Liners 4 mm ID Double Taper, Length 78.5 mm PK25

*Note - Bruker/Varian 1077 injectors and Thermo Trace 1300 series use 78.5 mm "Agilent" Liners*

For more information about this product visit [www.sge.com](http://www.sge.com) or contact [techsupport@sge.com](mailto:techsupport@sge.com).

## Injection Port | Inlet Liner FocusLiner®

### Spot the Difference in the SGE Lineup!

The SGE inlet liner range aims to make it simple for all gas chromatographers to select the correct liner.

Choosing the right inlet liner and injection parameters can increase peak areas and reduce detection limits by up to 300 %.

- Easy to choose - color coded by geometry to simplify your selection.
- Easy to use - contains o-rings so you're ready to go.
- Confidence in your analysis - certified deactivation.

### Features and Benefits

The SGE FocusLiner® uses a unique design to hold the quartz wool in the correct position.

- Two focus points in the liner ensures quartz wool remains in the optimum location.
- The wiping of the needle by the quartz wool prevents droplet formation ensuring excellent reproducibility.
- The presence of the quartz wool improves vaporization minimizing high molecular weight discrimination.

### Recommended Applications

The FocusLiner is recommended for the following sample or injection modes:

- General purpose.
- Concentrated samples.
- Dirty samples.
- Split/Splitless injection mode.



Color coded blue.

### Product Specifications

FocusLiner available for Agilent, PerkinElmer, Shimadzu, Thermo Scientific, and Bruker/Varian injectors.

Injector	Length (mm)	OD (mm)	ID (mm)
Agilent	78.5	6.3	4
Agilent	78.5	6.3	2.3
Bruker/Varian	78.5	6.3	4
Bruker/Varian	78.5	6.3	2.3
Bruker/Varian	74	6.3	4
Bruker/Varian	72	6.3	4
Bruker/Varian	72	6.3	2.3
Bruker/Varian	54	5	3.4
PerkinElmer	92	6.2	4
PerkinElmer	86.2	4	2
Shimadzu	99	5	3.4
Shimadzu	95	5	3.4
Thermo	105	8	5
Thermo	78.5	6.3	4
Thermo	78.5	6.3	2.3

For more information about this product visit [www.sge.com](http://www.sge.com) or contact [techsupport@sge.com](mailto:techsupport@sge.com).



## Injection Port | Inlet Liner FocusLiner®

Spot the Difference in the SGE Lineup!

Part Number	Part Description and Detail
<b>Agilent</b>	
09200501	Agilent Inlet Liner 2.3 mm ID FocusLiner, Length 78.5 mm PK1
092005	Agilent Inlet Liners 2.3 mm ID FocusLiner, Length 78.5 mm PK5
092008	Agilent Inlet Liners 2.3 mm ID FocusLiner, Length 78.5 mm PK25
09200201	Agilent Inlet Liner 4 mm ID FocusLiner, Length 78.5 mm PK1
092002	Agilent Inlet Liners 4 mm ID FocusLiner, Length 78.5 mm PK5
092219	Agilent Inlet Liners 4 mm ID FocusLiner, Length 78.5 mm PK25
<b>ATAS</b>	
09227201	ATAS Inlet Liner FocusLiner, Length 81 mm PK1
092272	ATAS Inlet Liners FocusLiner, Length 81 mm PK5
<b>Bruker/Varian</b>	
09211301	Bruker/Varian 1075/1077 Inlet Liner 2.3 mm ID FocusLiner, Length 72 mm PK1
09202201	Bruker/Varian 1075/1077 Inlet Liner 4 mm ID FocusLiner, Length 72 mm PK1
09202801	Bruker/Varian 1075/1077 Inlet Liner 4 mm ID FocusLiner (Top-end Rest), Length 72 mm PK1
092022	Bruker/Varian 1075/1077 Inlet Liners 4 mm ID FocusLiner, Length 72 mm PK5
092028	Bruker/Varian 1075/1077 Inlet Liners 4 mm ID FocusLiner (Top-end Rest), Length 72 mm PK5
09202601	Bruker/Varian 1075/1077 Inlet Liner 4 mm ID FocusLiner, Length 74 mm PK1
09203701	Bruker/Varian 1078/1079 Inlet Liner 3.4 mm ID FocusLiner, Length 54 mm PK1
092037	Bruker/Varian 1078/1079 Inlet Liners 3.4 mm ID FocusLiner, Length 54 mm PK5
09203725	Bruker/Varian 1078/1079 Inlet Liners 3.4 mm ID FocusLiner, Length 54 mm PK25
<b>PerkinElmer</b>	
09210101	PerkinElmer Inlet Liner 2 mm ID FocusLiner, Length 86.2 mm PK1
092101	PerkinElmer Inlet Liners 2 mm ID FocusLiner, Length 86.2 mm PK5
09209201	PerkinElmer Inlet Liner 4 mm ID FocusLiner, Length 92 mm PK1
092092	PerkinElmer Inlet Liners 4 mm ID FocusLiner, Length 92 mm PK5
09209225	PerkinElmer Inlet Liners 4 mm ID FocusLiner, Length 92 mm PK25
<b>Shimadzu</b>	
09206201	Shimadzu 2010/17A Inlet Liner 3.4 mm ID FocusLiner, Length 95 mm PK1
092062	Shimadzu 2010/17A Inlet Liners 3.4 mm ID FocusLiner, Length 95 mm PK5
09206225	Shimadzu 2010/17A Inlet Liners 3.4 mm ID FocusLiner, Length 95 mm PK25
09205901	Shimadzu 2010/17A Inlet Liner 3.4 mm ID FocusLiner, Length 95 mm PK1*
092059	Shimadzu 2010/17A Inlet Liners 3.4 mm ID FocusLiner, Length 95 mm PK5*
09205925	Shimadzu 2010/17A Inlet Liners 3.4 mm ID FocusLiner, Length 95 mm PK25*
09206501	Shimadzu 14 Inlet Liner 3.4 mm ID FocusLiner, Length 99 mm PK1
092065	Shimadzu 14 Inlet Liners 3.4 mm ID FocusLiner, Length 99 mm PK5
<b>Thermo Scientific</b>	
09204625	Thermo Scientific Inlet Liners 5 mm ID FocusLiner, Length 105 mm PK25
09204901	Thermo Scientific Inlet Liner (for 50 mm Needle) 5 mm ID FocusLiner, Length 105 mm PK1
092048	Thermo Scientific Inlet Liners (for 50 mm Needle) 5 mm ID FocusLiner, Length 105 mm PK5
092049	Thermo Scientific Inlet Liners (for 50 mm Needle) 5 mm ID FocusLiner (Top-end Rest), Length 105 mm PK5
09204501	Thermo Scientific Inlet Liner (for 70 mm Needle) 5 mm ID FocusLiner, Length 105 mm PK1
09204601	Thermo Scientific Inlet Liner (for 70 mm Needle) 5 mm ID FocusLiner (Top-end Rest), Length 105 mm PK1
092045	Thermo Scientific Inlet Liners (for 70 mm Needle) 5 mm ID FocusLiner, Length 105 mm PK5
092046	Thermo Scientific Inlet Liners (for 70 mm Needle) 5 mm ID FocusLiner (Top-end Rest), Length 105 mm PK5

Note - Bruker/Varian 1077 injectors and Thermo Trace 1300 series use 78.5 mm "Agilent" Liners

\* When using a standard 42 mm needle for autosamplers, the sample will be injected on top of the wool for this liner.

For more information about this product visit [www.sge.com](http://www.sge.com) or contact [techsupport@sge.com](mailto:techsupport@sge.com).

## Injection Port | Inlet Liner PTV/LVI

### Spot the Difference in the SGE Lineup!

The SGE inlet liner range aims to make it simple for all gas chromatographers to select the correct liner.

Choosing the right inlet liner and injection parameters can increase peak areas and reduce detection limits by up to 300 %.

#### Features and Benefits

- PTV and LVI liners generally have sintered glass beads or powder to increase the surface area and trap nonvolatile residue.
- PTV liners use baffles or a wisp of quartz wool to aid in vaporization of samples and retain droplets during low temperature injections.
- Side hole needles are recommended for these techniques to ensure effective distribution of sample within the liner.

#### Recommended Applications

PTV/LVI liners are recommended for the following sample or injection modes:

- Trace level analyses.
- PTV/LVI.
- Large volume Injections.



#### Product Specifications

PTV/LVI liners available for Agilent/Gerstel, PerkinElmer, Shimadzu 2010 injector, Thermo Scientific, and Varian/Bruker 1078/1079 injectors.

Injector	Length (mm)	OD (mm)	ID (mm)
Agilent/Gerstel	71	3	1.8
PerkinElmer	86.2	4	2
Shimadzu	95	3.1	1.5
Thermo	120	2.75	1.75
Thermo	120	2.75	0.78/1.8
Varian/Bruker	54	5	1.8/3.4

For more information about this product visit [www.sge.com](http://www.sge.com) or contact [techsupport@sge.com](mailto:techsupport@sge.com).

## Injection Port | Inlet Liner PTV/LVI

### Spot the Difference in the SGE Lineup!

Part Number	Part Description and Detail
<b>Agilent</b>	
09224601	Agilent Inlet Liner PTV Straight, Length 71 mm PK1
092246	Agilent Inlet Liners PTV Straight, Length 71 mm PK5
09221001	Agilent AC Inlet Liner PTV Untreated, Length 73 mm PK1
092210	Agilent AC Inlet Liners PTV Untreated, Length 73 mm PK5
092211	Agilent AC Inlet Liners PTV Untreated, Length 73 mm PK25
<b>Agilent/Gerstel</b>	
09224301	Agilent Gerstel CIS 4 Inlet Liner LVI, Length 71 mm PK1
092243	Agilent Gerstel CIS 4 Inlet Liners LVI, Length 71 mm PK5
<b>Bruker/Varian</b>	
09224501	Bruker/Varian 1078/1079 Inlet Liner LVI, Length 54 mm PK1
092245	Bruker/Varian 1078/1079 Inlet Liners LVI, Length 54 mm PK5
09224525	Bruker/Varian 1078/1079 Inlet Liners LVI, Length 54 mm PK25
<b>PerkinElmer</b>	
09209701	PerkinElmer Inlet Liner PTV Gooseneck 1 mm ID, Length 88 mm PK1
092097	PerkinElmer Inlet Liners PTV Gooseneck 1 mm ID, Length 88 mm PK5
<b>PerkinElmer PSS</b>	
09224401	PerkinElmer PSS Inlet Liner PTV, Length 86.2 mm PK1
092244	PerkinElmer PSS Inlet Liners PTV, Length 86.2 mm PK5
<b>Shimadzu</b>	
092042501	Shimadzu Inlet Liner PTV 3 Baffle, Length 95 mm PK1
0920425	Shimadzu Inlet Liners PTV 3 Baffle, Length 95 mm PK5
09208801	Shimadzu 17A Inlet Liner PTV Treated, Length 95 mm PK1
09229201	Shimadzu 2010 Inlet Liner LVI Straight Non-Sintered with Wool, Length 95 mm PK1
092292	Shimadzu 2010 Inlet Liners LVI Straight Non-Sintered with Wool, Length 95 mm PK5
<b>Thermo Scientific</b>	
09215501	Thermo Scientific Inlet Liner LVI, Length 120 mm PK1
092155	Thermo Scientific Inlet Liners LVI, Length 120 mm PK5
09215525	Thermo Scientific Inlet Liners LVI, Length 120 mm PK25

Note - Bruker/Varian 1077 injectors use 78.5mm "Agilent" Liners

For more information about this product visit [www.sge.com](http://www.sge.com) or contact [techsupport@sge.com](mailto:techsupport@sge.com).

# Injection Port | Inlet Liner Straight

## Spot the Difference in the SGE Lineup!

The SGE inlet liner range aims to make it simple for all gas chromatographers to select the correct liner.

Choosing the right inlet liner and injection parameters can increase peak areas and reduce detection limits by up to 300 %.

- Easy to choose - color coded by geometry to simplify your selection.
- Easy to use - contains o-rings so you're ready to go.
- Confidence in your analysis - certified deactivation.

### Features and Benefits

- Straight liners facilitate higher split flows.
- Narrow bore straight liners facilitate fast GC work.
- Small injection volumes of less than 0.5  $\mu\text{L}$  are best used.
- Narrow bore straight liners improve focusing of gaseous samples (purge, trap and headspace).

### Recommended Applications

Straight liners are recommended for the following sample or injection modes:

- General purpose.
- Concentrated samples.
- Dirty samples (only if quartz wool is present).
- Gaseous samples.
- Purge and trap.
- Headspace.
- Split/splitless.



Color coded purple.

### Product Specifications

Straight liners available for Agilent, PerkinElmer, Shimadzu 2010, 17A, 2014 and 2025 injectors, Thermo Scientific, and Varian/Bruker 1177 & 1078/1079 injectors.

Injector	Length (mm)	OD (mm)	ID (mm)
Agilent	78.5	6.3	4
Agilent	78.5	6.3	1.2
Agilent	78.5	6.3	2
PerkinElmer	92	6.2	4
PerkinElmer	92	6.2	2
PerkinElmer	86.2	4	2
PerkinElmer	112	6	3
PerkinElmer	100	5	3
Shimadzu	95	5	2.6
Shimadzu	95	5	3.4
Thermo	105	8	3
Thermo	105	8	5
Thermo	78.5	6.3	4
Varian/Bruker	78.5	6.3	4
Varian/Bruker	78.5	6.3	1.2
Varian/Bruker	54	5	0.5

For more information about this product visit [www.sge.com](http://www.sge.com) or contact [techsupport@sge.com](mailto:techsupport@sge.com).

## Injection Port | Inlet Liner Straight

Spot the Difference in the SGE Lineup!

Part Number	Part Description and Detail
<b>Agilent</b>	
09201601	Agilent Inlet Liner 1.2 mm ID Straight, Length 78.5 mm PK1
092016	Agilent Inlet Liners 1.2 mm ID Straight, Length 78.5 mm PK5
092224	Agilent Inlet Liners 1.2 mm ID Straight, Length 78.5 mm PK25
09200401	Agilent Inlet Liner with Quartz Wool 2 mm ID Straight, Length 78.5 mm PK1
092004	Agilent Inlet Liners with Quartz Wool 2 mm ID Straight, Length 78.5 mm PK5
09200701	Agilent Inlet Liner 4 mm ID Straight, Length 78.5 mm PK1
092007	Agilent Inlet Liners 4 mm ID Straight, Length 78.5 mm PK5
092222	Agilent Inlet Liners 4 mm ID Straight, Length 78.5 mm PK25
09200101	Agilent Inlet Liner with Quartz Wool 4 mm ID, Length 78.5 mm PK1
092001	Agilent Inlet Liners with Quartz Wool 4 mm ID, Length 78.5 mm PK5
092220	Agilent Inlet Liners with Quartz Wool 4 mm ID, Length 78.5 mm PK25
09224601	Agilent PTV Inlet Liner, Single Baffle Straight, Length 71 mm PK1
092246	Agilent PTV Inlet Liners, Single Baffle Straight, Length 71 mm PK5
09223401	Agilent Inlet Liner Packed Column, Length 92 mm PK1
092234	Agilent Inlet Liners Packed Column, Length 92 mm PK5
092235	Agilent Inlet Liners Packed Column, Length 92 mm PK25
<b>Bruker/Varian</b>	
09203101	Bruker/Varian 1078/1079 Inlet Liner 0.5 mm ID Straight, Length 54 mm PK1
092031	Bruker/Varian 1078/1079 Inlet Liners 0.5 mm ID Straight, Length 54 mm PK5
092117	Bruker/Varian 1078/1079 Inlet Liners SPME 0.75 mm ID, Length 54 mm PK5
09202701	Bruker/Varian 1093/1094 Inlet Liner 0.5 mm ID, Length 54 mm PK1
092027	Bruker/Varian 1093/1094 Inlet Liners 0.5 mm ID, Length 54 mm PK5
092030	Bruker/Varian 1093/1094 Inlet Liners 0.8 mm ID (rest 0.25mm), Length 54 mm PK5
092034	Bruker/Varian 1093/1094 Inlet Liners 0.8 mm ID (rest 0.50mm), Length 54 mm PK5
09203425	Bruker/Varian 1093/1094 Inlet Liners 0.8 mm ID, Length 54 mm PK25
<b>Dani</b>	
092503	Dani Inlet Liners with Quartz Wool 2 mm ID, Length 70 mm PK5
0925001	Dani Inlet Liner with Quartz Wool 4 mm ID, Length 70 mm PK1
092500	Dani Inlet Liners with Quartz Wool 4 mm ID, Length 70 mm PK5
092501	Dani Inlet Liners 4 mm ID Straight, Length 70 mm PK5
092502	Dani Inlet Liners 8 mm ID Straight, Length 70 mm PK5
<b>PerkinElmer</b>	
092098	PerkinElmer PSS Inlet Liners 2 mm ID, Length 86.2 mm PK5
09210301	PerkinElmer Inlet Liner 2 mm ID Straight, Length 92 mm PK1
092103	PerkinElmer Inlet Liners 2 mm ID Straight, Length 92 mm PK5
09210001	PerkinElmer Inlet Liner 4 mm ID Straight, Length 92 mm PK1
092100	PerkinElmer Inlet Liners 4 mm ID Straight, Length 92 mm PK5
09210025	PerkinElmer Inlet Liners 4 mm ID Straight, Length 92 mm PK25
09223601	PerkinElmer Inlet Liner Packed Column, Length 112 mm PK1
092236	PerkinElmer Inlet Liners Packed Column, Length 112 mm PK5
<b>Shimadzu</b>	
09208401	Shimadzu 9A/16A Inlet Liner 3.4 mm ID, Length 139 mm PK1
092084	Shimadzu 9A/16A Inlet Liners 3.4 mm ID, Length 139 mm PK5
09208901	Shimadzu 2010/17A Inlet Liner 0.75 mm ID, Length 95 mm PK1
092089	Shimadzu 2010/17A Inlet Liners 0.75 mm ID, Length 95 mm PK5
092086101	Shimadzu 2010/17A Inlet Liner 2.6 mm ID, Length 95 mm PK1
0920861	Shimadzu 2010/17A Inlet Liners 2.6 mm ID, Length 95 mm PK5
09206401	Shimadzu 2010/17A Inlet Liner 3.4 mm ID, Length 95 mm PK1
092064	Shimadzu 2010/17A Inlet Liners 3.4 mm ID, Length 95 mm PK5
09229201	Shimadzu 2010/17A Inlet Liner Non-Sintered LVI with Wool Straight, Length 95 mm PK1
<b>Thermo Scientific</b>	
09214801	Thermo Scientific Inlet Liner 0.8 mm ID Straight, Length 105 mm PK1
092148	Thermo Scientific Inlet Liners 0.8 mm ID Straight, Length 105 mm PK5
09214701	Thermo Scientific Inlet Liner 3 mm ID, Length 105 mm PK1
092147	Thermo Scientific Inlet Liners 3 mm ID, Length 105 mm PK5
09215001	Thermo Scientific Inlet Liner 5 mm ID Straight, Length 105 mm PK1
092150	Thermo Scientific Inlet Liners 5 mm ID Straight, Length 105 mm PK5
092142	Thermo Scientific Trace Inlet Liners 2 mm ID, Length 120 mm PK5

Note - Bruker/Varian 1077 injectors and Thermo Trace 1300 series use 78.5 mm "Agilent" Liners

For more information about this product visit [www.sge.com](http://www.sge.com) or contact [techsupport@sge.com](mailto:techsupport@sge.com).

# Injection Port | Inlet Liner Taper/Gooseneck

## Spot the Difference in the SGE Lineup!

The SGE inlet liner range aims to make it simple for all gas chromatographers to select the correct liner.

Choosing the right inlet liner and injection parameters can increase peak areas and reduce detection limits by up to 300 %.

- Easy to choose - color coded by geometry to simplify your selection.
- Easy to use - contains o-rings so you're ready to go.
- Confidence in your analysis - certified deactivation.

### Features and Benefits

- A bottom taper focuses sample onto the head of the column and minimizes sample contact with metal parts of the inlet.
- A taper at the top aids in minimizing sample flashback.
- Remember – the addition of quartz wool to your inlet liner promotes mixing of analytes, aids the vaporization of liquid samples, works as a trap to collect non-volatile residue in the sample (i.e. protects capillary column from 'dirty' samples).

### Recommended Applications

Taper / Gooseneck liners are recommended for the following sample or injection modes:

- Trace level analysis
- Active Samples
- Split/Splitless injection types

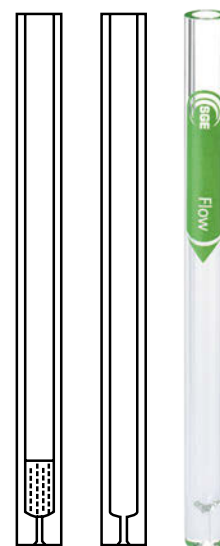

Color coded green.

### Product Specifications

Injector	Length (mm)	OD (mm)	ID (mm)
<b>Bottom Taper available for Agilent, PerkinElmer, Shimadzu, Thermo Scientific, and Varian/Bruker 1177 and 1078/1079 injectors</b>			
Agilent	78.5	6.3	4
Agilent	78.5	6.3	2.3
PerkinElmer	92	6.2	4
Shimadzu	99	5	3.4
Shimadzu	95	5	3.4
Thermo	105	8	5
Thermo	105	8	3
Thermo	78.5	6.3	4
Thermo	78.5	6.3	2.3
Varian/Bruker	78.5	6.3	4
Varian/Bruker	78.5	6.3	2.3
Varian/Bruker	54	5	3.4
<b>Top Taper available for Agilent, PerkinElmer 8000 &amp; Sigma Series, Thermo Scientific, and Varian/Bruker 1177, 1075/1077 &amp; 1078/1079 injectors</b>			
Agilent	78.5	6.3	4
PerkinElmer	100	5	2
Shimadzu	99	5	3.4
Thermo	105	8	5
Thermo	78.5	6.3	4
Varian/Bruker	78.5	6.3	4
Varian/Bruker	72	6.3	4
Varian/Bruker	74	6.3	4
Varian/Bruker	74	6.3	2
Varian/Bruker	54	5	1.8 / 3.4
<b>Gooseneck available for Agilent, Shimadzu, and Varian/Bruker 1177 injectors</b>			
Agilent	78.5	6.3	4
Agilent	78.5	6.3	2.3
Shimadzu	99	5	3.4
Shimadzu	95	5	3.4
Varian/Bruker	78.5	6.3	4
Varian/Bruker	78.5	6.3	2

For more information about this product visit [www.sge.com](http://www.sge.com) or contact [techsupport@sge.com](mailto:techsupport@sge.com).

# Injection Port | Inlet Liner Taper/Gooseneck

## Spot the Difference in the SGE Lineup!

Part Number	Part Description and Detail
<b>Agilent</b>	
09201301	Agilent Inlet Liner Gooseneck 2 mm ID, Length 78.5 mm PK1
092013	Agilent Inlet Liners Gooseneck 2 mm ID, Length 78.5 mm PK5
09201001	Agilent Inlet Liner Gooseneck with Quartz Wool 4 mm ID, Length 78.5 mm PK1
092010	Agilent Inlet Liners Gooseneck with Quartz Wool 4 mm ID, Length 78.5 mm PK5
092223	Agilent Inlet Liners Gooseneck with Quartz Wool 4 mm ID, Length 78.5 mm PK25
09201701	Agilent Inlet Liner Tapered 4 mm ID, Length 78.5 mm PK1
092017	Agilent Inlet Liners Tapered 4 mm ID, Length 78.5 mm PK5
092229	Agilent Inlet Liners Tapered 4 mm ID, Length 78.5 mm PK25
09201901	Agilent Inlet Liner Tapered with Quartz Wool 4 mm ID, Length 78.5 mm PK1
092019	Agilent Inlet Liners Tapered with Quartz Wool 4 mm ID, Length 78.5 mm PK5
092218	Agilent Inlet Liners Tapered with Quartz Wool 4 mm ID, Length 78.5 mm PK25
<b>Bruker/Varian</b>	
09202401	Bruker/Varian 1075/1077 Inlet Liner Restricted 2 mm ID, Length 74 mm PK1
092024	Bruker/Varian 1075/1077 Inlet Liners Restricted 2 mm ID, Length 74 mm PK5
092228	Bruker/Varian 1075/1077 Inlet Liners Restricted 2 mm ID, Length 74 mm PK25
09202101	Bruker/Varian 1075/1077 Inlet Liner Restricted with Quartz Wool 4 mm ID, Length 72 mm PK1
092021	Bruker/Varian 1075/1077 Inlet Liners Restricted with Quartz Wool 4 mm ID, Length 72 mm PK5
09222125	Bruker/Varian 1075/1077 Inlet Liners Restricted with Quartz Wool 4 mm ID, Length 72 mm PK25
09203801	Bruker/Varian 1078/1079 Inlet Liner Tapered 3.4 mm ID, Length 54 mm PK1
092038	Bruker/Varian 1078/1079 Inlet Liners Tapered 3.4 mm ID, Length 54 mm PK5
09203825	Bruker/Varian 1078/1079 Inlet Liners Tapered 3.4 mm ID, Length 54 mm PK25
09203901	Bruker/Varian 1078/1079 Inlet Liner Tapered 2 mm ID, Length 54 mm PK1
092039	Bruker/Varian 1078/1079 Inlet Liners Tapered 2 mm ID, Length 54 mm PK5
<b>Dani</b>	
092504	Dani Inlet Liners Tapered 4 mm ID, Length 70 mm PK5
092505	Dani Inlet Liners Tapered with Quartz Wool 4 mm ID, Length 70 mm PK5
<b>Optic</b>	
09227301	Optic Inlet Liner with Frit 3 mm ID, Length 81 mm PK1
092273	Optic Inlet Liners with Frit 3 mm ID, Length 81 mm PK5
<b>PerkinElmer</b>	
09209701	PerkinElmer Inlet Liner PTV Gooseneck 1 mm ID, Length 88 mm PK1
092097	PerkinElmer Inlet Liners PTV Gooseneck 1 mm ID, Length 88 mm PK5
09209401	PerkinElmer Inlet Liner Tapered 2 mm ID, Length 100 mm PK1 (for 5000 and Sigma Series)
09209101	PerkinElmer Inlet Liner Gooseneck 3 mm ID, Length 100 mm PK1 (for 5000 and Sigma Series)
092091	PerkinElmer Inlet Liners Gooseneck 3 mm ID, Length 100 mm PK5 (for 5000 and Sigma Series)
09209901	PerkinElmer Inlet Liner Tapered 4 mm ID, Length 92 mm PK1
0920990	PerkinElmer Inlet Liners Tapered 4 mm ID, Length 92 mm PK5
<b>Shimadzu</b>	
09208701	Shimadzu 2010/17A Inlet Liner Tapered 2.6 mm ID, Length 95 mm PK1
092087	Shimadzu 2010/17A Inlet Liners Tapered 2.6 mm ID, Length 95 mm PK5
09208501	Shimadzu 2010/17A Inlet Liner Gooseneck 3.4 mm ID, Length 95 mm PK1
092085	Shimadzu 2010/17A Inlet Liners Gooseneck 3.4 mm ID, Length 95 mm PK5
09208525	Shimadzu 2010/17A Inlet Liners Gooseneck 3.4 mm ID, Length 95 mm PK25
09206101	Shimadzu 2010/17A Inlet Liner Gooseneck with Quartz Wool 3.4 mm ID, Length 95 mm PK1
092061	Shimadzu 2010/17A Inlet Liners Gooseneck with Quartz Wool 3.4 mm ID, Length 95 mm PK5
09207101	Shimadzu 2010/17A Inlet Liner Tapered 3.4 mm ID, Length 95 mm PK1
092071	Shimadzu 2010/17A Inlet Liners Tapered 3.4 mm ID, Length 95 mm PK5
09207701	Shimadzu 2010/17A Inlet Liner Gooseneck 3.4 mm ID, Length 95 mm PK1
092077	Shimadzu 2010/17A Inlet Liners Gooseneck 3.4 mm ID, Length 95 mm PK5
092083101	Shimadzu 14 Inlet Liner Tapered 3.4 mm ID, Length 99 mm PK1
0920831	Shimadzu 14 Inlet Liners Tapered 3.4 mm ID, Length 99 mm PK5
092083125	Shimadzu 14 Inlet Liners Tapered 3.4 mm ID, Length 99 mm PK25
09208201	Shimadzu 14 Inlet Liner Mid-Gooseneck 3.4 mm ID, Length 99 mm PK1
092082	Shimadzu 14 Inlet Liners Mid-Gooseneck 3.4 mm ID, Length 99 mm PK5
<b>Thermo Scientific</b>	
09214101	Thermo Scientific Inlet Liner Tapered 3 mm ID, Length 105 mm PK1
09214125	Thermo Scientific Inlet Liners Tapered 3 mm ID, Length 105 mm PK25
09214401	Thermo Scientific Inlet Liner Tapered 5 mm ID, Length 105 mm PK1
092144	Thermo Scientific Inlet Liners Tapered 5 mm ID, Length 105 mm PK5
09214425	Thermo Scientific Inlet Liners Tapered 5 mm ID, Length 105 mm PK25

Note - Bruker/Varian 1077 injectors and Thermo Trace 1300 series use 78.5 mm "Agilent" Liners

For more information about this product visit [www.sge.com](http://www.sge.com) or contact [techsupport@sge.com](mailto:techsupport@sge.com).

## Injection Port | Inlet Liner Taper FocusLiner®

Spot the Difference in the SGE Lineup!

The SGE inlet liner range aims to make it simple for all gas chromatographers to select the correct liner.

Choosing the right inlet liner and injection parameters can increase peak areas and reduce detection limits by up to 300 %.

- Easy to choose - color coded by geometry to simplify your selection.
- Easy to use - contains o-rings so you're ready to go.
- Confidence in your analysis - certified deactivation.

### Features and Benefits

- Bottom taper focuses sample onto the head of the column and minimizes contact with metal parts of the inlet.
- A taper at the top aids in minimizing sample flashback.
- Ensures quartz wool remains in the correct position in the liner.
- Excellent reproducibility results from the wiping of the sample from the syringe needle and the prevention of droplet formation.

### Recommended Applications

The Taper FocusLiner® is recommended for the following sample or injection modes:

- Trace level analysis.
- Splitless.
- Dirty sample.
- Wide boiling point range.

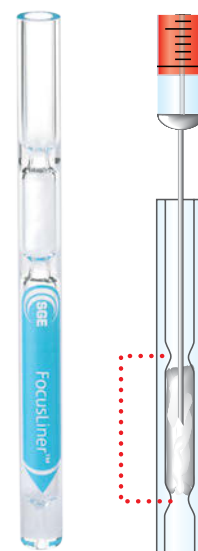

Color coded aqua.

### Product Specifications

Taper FocusLiner available for Agilent, PerkinElmer, Shimadzu, Thermo Scientific, and Varian/Bruker injectors.

Injector	Length (mm)	OD (mm)	ID (mm)
Agilent	78.5	6.3	4
Agilent	78.5	6.3	2.3
PerkinElmer	92	6.2	4
Shimadzu	99	5	3.4
Shimadzu	95	5	3.4
Thermo	105	8	5
Thermo	78.5	6.3	4
Thermo	78.5	6.3	2.3
Varian/Bruker	78.5	6.3	2.3
Varian/Bruker	54	5	3.4
Varian/Bruker	72	6.3	4

For more information about this product visit [www.sge.com](http://www.sge.com) or contact [techsupport@sge.com](mailto:techsupport@sge.com).



## Injection Port | Inlet Liner Taper FocusLiner®

Spot the Difference in the SGE Lineup!

Part Number	Part Description and Detail
<b>Agilent</b>	
09200301	Agilent Inlet Liner 4 mm ID Tapered FocusLiner, Length 78.5 mm PK1
092003	Agilent Inlet Liners 4 mm ID Tapered FocusLiner, Length 78.5 mm PK5
092011	Agilent Inlet Liners 4 mm ID Tapered FocusLiner, Length 78.5 mm PK25
09211101	Agilent Inlet Liner 2.3 mm ID Tapered FocusLiner, Length 78.5 mm PK1
092111	Agilent Inlet Liners 2.3 mm ID Tapered FocusLiner, Length 78.5 mm PK5
092115	Agilent Inlet Liners 2.3 mm ID Tapered FocusLiner, Length 78.5 mm PK25
<b>Bruker/Varian</b>	
09203601	Bruker/Varian 1075/1077 Inlet Liner 3.4 mm ID Tapered FocusLiner, Length 54 mm PK1
092036	Bruker/Varian 1075/1077 Inlet Liners 3.4 mm ID Tapered FocusLiner, Length 54 mm PK5
09202501	Bruker/Varian 1075/1077 Inlet Liner 4 mm ID Tapered FocusLiner, Length 72 mm PK1
<b>Dani</b>	
092506	Dani Inlet Liners 4 mm ID Tapered FocusLiner, Length 70 mm PK5
<b>PerkinElmer</b>	
09209501	PerkinElmer Inlet Liner 4 mm ID Tapered FocusLiner, Length 92 mm PK1
092095	PerkinElmer Inlet Liners 4 mm ID Tapered FocusLiner, Length 92 mm PK5
09209525	PerkinElmer Inlet Liners 4 mm ID Tapered FocusLiner, Length 92 mm PK25
<b>Shimadzu</b>	
09206801	Shimadzu 2010/17A Inlet Liner 3.4 mm ID Tapered FocusLiner, Length 95 mm PK1
092068	Shimadzu 2010/17A Inlet Liners 3.4 mm ID Tapered FocusLiner, Length 95 mm PK5
09206825	Shimadzu 2010/17A Inlet Liners 3.4 mm ID Tapered FocusLiner, Length 95 mm PK25
09205801	Shimadzu 2010/17A Inlet Liner 3.4 mm ID Tapered FocusLiner, Length 95 mm PK1
092058	Shimadzu 2010/17A Inlet Liners 3.4 mm ID Tapered FocusLiner, Length 95 mm PK5
09205825	Shimadzu 2010/17A Inlet Liners 3.4 mm ID Tapered FocusLiner, Length 95 mm PK25
09206601	Shimadzu 14A Inlet Liner 3.4 mm ID Tapered FocusLiner, Length 99 mm PK1
092066	Shimadzu 14A Inlet Liners 3.4 mm ID Tapered FocusLiner, Length 99 mm PK5

Note - Bruker/Varian 1077 injectors and Thermo Trace 1300 series use 78.5 mm "Agilent" Liners

For more information about this product visit [www.sge.com](http://www.sge.com) or contact [techsupport@sge.com](mailto:techsupport@sge.com).

## Injection Port | Signet Septa EC Grade

### Give Your GC the Seal of Approval

Desired septa attributes:

- Reliably seal against the carrier gas pressure in the inlet.
- Capable of being pierced and resealing time after time without pieces of the septa being deposited in the GC inlet system.
- Does not contaminate or bleed material into the chromatographic system.

#### Features and Benefits

- Combines significantly longer injection life, low bleed and low injection port adhesion.
- Blister packed to prevent absorption from the environment.

#### Recommended Applications

High turnover applications.



#### Product Specifications

Sizes available (mm): 6, 7, 8, 9, 10, 11, 11.5, 12.5, 17, plug.

Material	Durability	Resealing	Solvent Resistance	Tear Resistance	Maximum Temperature
High temperature silicone	Excellent	Excellent	Excellent	Excellent	400 °C, 330 °C for 17 mm size

For more information about this product visit [www.sge.com](http://www.sge.com) or contact [techsupport@sge.com](mailto:techsupport@sge.com).

## Injection Port | Signet Septa EC Grade

Give Your GC the Seal of Approval

Part Number	Part Description and Detail
041841	6 mm Diameter Long Life EC Septa PK50
041842	7 mm Diameter Long Life EC Septa PK50
041843	8 mm Diameter Long Life EC Septa PK50
041900	9 mm Diameter Long Life EC Septa PK25
041901	9.5 mm Diameter Long Life EC Septa PK25
041845	10 mm Diameter Long Life EC Septa PK50
041902	11 mm Diameter Long Life EC Septa PK25
041912	11 mm Diameter Long Life EC Septa PK50
041904	11.5 mm Diameter Long Life EC Septa PK25
041906	12.5 mm Diameter Long Life EC Septa PK24
041903	17 mm Diameter Long Life EC Septa PK24
041905	Shimadzu Plug Style Long Life EC Septa PK50

For more information about this product visit [www.sge.com](http://www.sge.com) or contact [techsupport@sge.com](mailto:techsupport@sge.com).

## Injection Port | Signet Septa GP Grade

Give Your GC the Seal of Approval

Desired septa attributes:

- Reliably seal against the carrier gas pressure in the inlet.
- Capable of being pierced and resealing time after time without pieces of the septa being deposited in the GC inlet system.
- Does not contaminate or bleed material into the chromatographic system.



### Features and Benefits

- Combines significantly longer injection life, low bleed and low injection port adhesion.
- Blister packed to prevent absorption from the environment.

### Recommended Applications

Low temperature.

---

### Product Specifications

Sizes available (mm): 5, 6, 7, 8, 9, 9.5, 10, 11, 11.5, 12.5, 15.

Material	Durability	Resealing	Solvent Resistance	Tear Resistance	Maximum Temperature
Silicone	Good	Good	Excellent	Good	200 °C

For more information about this product visit [www.sge.com](http://www.sge.com) or contact [techsupport@sge.com](mailto:techsupport@sge.com).

## Injection Port | Signet Septa GP Grade

Give Your GC the Seal of Approval

Part Number	Part Description and Detail
041820	5 mm Diameter General Purpose GP Septa PK50
041821	6 mm Diameter General Purpose GP Septa PK50
041822	7 mm Diameter General Purpose GP Septa PK50
041823	8 mm Diameter General Purpose GP Septa PK50
041824	9 mm Diameter General Purpose GP Septa PK50
0418240	9.5 mm Diameter General Purpose GP Septa PK50
041825	10 mm Diameter General Purpose GP Septa PK50
041826	11 mm Diameter General Purpose GP Septa PK50
041827	11.5 mm Diameter General Purpose GP Septa PK50
041828	12.5 mm Diameter General Purpose GP Septa PK48
041829	15 mm Diameter General Purpose GP Septa PK48

For more information about this product visit [www.sge.com](http://www.sge.com) or contact [techsupport@sge.com](mailto:techsupport@sge.com).

# Injection Port | Signet Septa HT Grade

## Give Your GC the Seal of Approval

Desired septa attributes:

- Reliably seal against the carrier gas pressure in the inlet.
- Capable of being pierced and resealing time after time without pieces of the septa being deposited in the GC inlet system.
- Does not contaminate or bleed material into the chromatographic system.



### Features and Benefits

- Bleed and temperature optimized combined with outstanding mechanical properties for the highest temperature applications.
- Retains softness and pierceability at high temperatures, and low injection port adhesion.
- Blister packed to prevent absorption from the environment.

### Recommended Applications

Highest temperature applications.

### Product Specifications

Sizes available (mm): 6, 9, 9.5, 11, 11.5, 12.5, 17, plug.

Material	Durability	Resealing	Solvent Resistance	Tear Resistance	Maximum Temperature
BTO silicone	Excellent	Excellent	Excellent	Excellent	400 °C, 330 °C for 17 mm size

For more information about this product visit [www.sge.com](http://www.sge.com) or contact [techsupport@sge.com](mailto:techsupport@sge.com).

## Injection Port | Signet Septa HT Grade

Give Your GC the Seal of Approval

Part Number	Part Description and Detail
0418991	5 mm Diameter Premium High Temperature HT Pre-Drilled Septa PK25
0418999	6 mm Diameter Premium High Temperature HT Pre-Drilled Septa (4 mm Thick) PK50
041896	9 mm Diameter Premium High Temperature HT Septa PK25
041897	9.5 mm Diameter Premium High Temperature HT Septa PK25
041881	9.5 mm Diameter Premium High Temperature HT Septa PK100
041883	11 mm Diameter Premium High Temperature HT Septa PK100
041898	11 mm Diameter Premium High Temperature HT Septa PK25
041899	11.5 mm Diameter Premium High Temperature HT Septa PK25
0418992	12.5 mm Diameter Premium High Temperature HT Septa PK24
0418990	17 mm Diameter Premium High Temperature HT Septa PK24
041895	Shimadzu Plug Style Premium High Temperature HT Septa PK50

For more information about this product visit [www.sge.com](http://www.sge.com) or contact [techsupport@sge.com](mailto:techsupport@sge.com).

## Injection Port | Signet Septa MN Grade

Give Your GC the Seal of Approval

Desired septa attributes:

- Reliably seal against the carrier gas pressure in the inlet.
- Capable of being pierced and resealing time after time without pieces of the septa being deposited in the GC inlet system.
- Does not contaminate or bleed material into the chromatographic system.



### Features and Benefits

- Premium septum for autosamplers with up to 400 injections per septum.
- Comes supplied in a blister pack which prevent absorption from the environment.

### Recommended Applications

Premium septa for autosamplers with up to 400 injections per septum.

---

### Product Specifications

Sizes available (mm): 5, 9, 11, 11.5, 12.5, 17

Material	Durability	Resealing	Solvent Resistance	Tear Resistance	Maximum Temperature
High temperature silicone	Excellent	Excellent	Excellent	Excellent	400 °C, 330 °C for 17 mm size

For more information about this product visit [www.sge.com](http://www.sge.com) or contact [techsupport@sge.com](mailto:techsupport@sge.com).



## Injection Port | Signet Septa MN Grade

Give Your GC the Seal of Approval

Part Number	Part Description and Detail
041850	5 mm Diameter Premium MN Septa PK50
041854	9 mm Diameter Premium MN Pre-Drilled Septa PK50
041856	11 mm Diameter Premium MN Pre-Drilled Septa PK48
0418501	11.5 mm Diameter Premium MN Septa PK48
0418503	12.5 mm Diameter Premium MN Septa PK48
0418505	17 mm Diameter Premium MN Septa PK48

For more information about this product visit [www.sge.com](http://www.sge.com) or contact [techsupport@sge.com](mailto:techsupport@sge.com).

# Injection Port | Kits

## Optimize Your Injection Port

Selecting the right injection port consumables for your instrument makes an important contribution to successful chromatography.

### Features and Benefits

Included in this kit are components designed to improve the performance of your GC.

There are many options for septum material, inlet liner geometry and ferrules for your injection port, this kit provides a selection of these to allow you to optimize performance for your specific application.

### Recommended Applications

- GC

### Product Specifications

#### Kit Inclusions:

- Injection Port Liners; Split/Splitless FocusLiner™, Split/Splitless Taper FocusLiner, Standard ConnectTite™.
- Septa: HT and EC Grade.
- Injection Port Tools.
- Capillary Cutting Tool.
- Liner Removal Forceps.
- USB/thumb drive containing SGE's Liner Selection Tool.
- SilTite® FingerTite Injection Port Starter Kit.
- Injection Port Fittings.
- 0.4 mm Ferrule x 2.
- 0.5 mm Ferrule x 2.
- SilTite FingerTite Nut x 1.
- SilTite FingerTite Installation Tool.

#### For Injection Systems:

- Agilent Systems - 7890, 6890, 5890, 4890, 6850 Injectors.
- Thermo Scientific Systems - TRACE and Focus Injectors.
- PerkinElmer Systems - AutoSystems™ and Clarus 500, 600 Injectors.
- Varian/Bruker Systems - 1177 Injector.
- Shimadzu Systems - SPL-2010 and SPL-2014 Injectors.

For more information about this product visit [www.sge.com](http://www.sge.com) or contact [techsupport@sge.com](mailto:techsupport@sge.com).





## Injection Port | Kits

Optimize Your Injection Port

Part Number	Part Description and Detail
495100	Injection Port Kit Agilent
495110	Injection Port Kit Thermo
495120	Injection Port Kit PerkinElmer
495130	Injection Port Kit Bruker 1177
495140	Injection Port Kit Shimadzu 2010

For more information about this product visit [www.sge.com](http://www.sge.com) or contact [techsupport@sge.com](mailto:techsupport@sge.com).



# Separations



## Separations | GC Column BP1

More than five decades of innovative phase technologies and unique fused silica production capabilities, together provide end-to-end separation solutions for all applications.

### Features and Benefits

- Classic crosslinked dimethyl polysiloxane technology.
- Excellent general purpose GC column.
- Low bleed.
- Non-polar.
- Suitable for all routine analyses.

### Recommended Applications

- Hydrocarbons.
- Aromatics.
- Pesticides.
- Phenol.
- Herbicides.
- Amines.

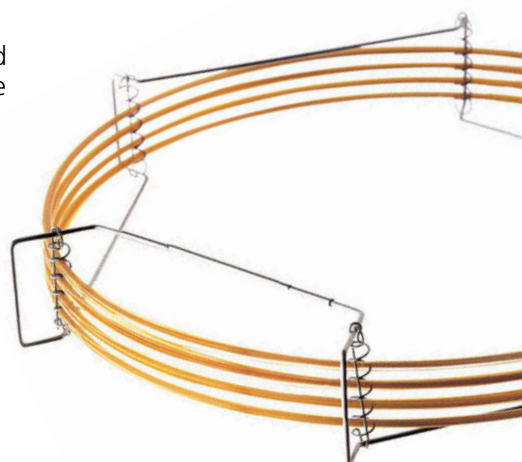

Fuels

Environment

Forensics

### Product Specifications

100 % Dimethyl Polysiloxane. Suitable replacement for: DB-1, DB-Petro, HP-1, HP-1MS, Rtx-1, Ultra-1, SPB-1, SPB-1 Sulfur, Petrocol DH, CP-Sil 5CB, VB-1, ZB-1, VF-1ms.

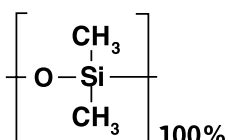

Film Thickness	Operating Temperature
0.1-1.0 $\mu\text{m}$	-60 $^{\circ}\text{C}$ to 340/360 $^{\circ}\text{C}$
1.5-3.0 $\mu\text{m}$	-60 $^{\circ}\text{C}$ to 300/320 $^{\circ}\text{C}$
4.0-5.0 $\mu\text{m}$	-60 $^{\circ}\text{C}$ to 280/300 $^{\circ}\text{C}$

For more information about this product visit [www.sge.com](http://www.sge.com) or contact [techsupport@sge.com](mailto:techsupport@sge.com).

## Separations | GC Column BP1

Part Number	Part Description and Detail
054022	0.1 mm ID x 0.1 µm Film Thickness x 10 m Length BP1 GC Capillary Column
054040	0.22 mm ID x 0.1 µm Film Thickness x 12 m Length BP1 GC Capillary Column
054041	0.22 mm ID x 0.1 µm Film Thickness x 25 m Length BP1 GC Capillary Column
054041	0.22 mm ID x 0.1 µm Film Thickness x 25 m Length BP1 GC Capillary Column
054047	0.22 mm ID x 0.25 µm Film Thickness x 25 m Length BP1 GC Capillary Column
054050	0.22 mm ID x 0.25 µm Film Thickness x 30 m Length BP1 GC Capillary Column
054048	0.22 mm ID x 0.25 µm Film Thickness x 50 m Length BP1 GC Capillary Column
054051	0.22 mm ID x 0.25 µm Film Thickness x 60 m Length BP1 GC Capillary Column
054053	0.22 mm ID x 1 µm Film Thickness x 25 m Length BP1 GC Capillary Column
054054	0.22 mm ID x 1 µm Film Thickness x 50 m Length BP1 GC Capillary Column
054039	0.25 mm ID x 0.1 µm Film Thickness x 15 m Length BP1 GC Capillary Column
054043	0.25 mm ID x 0.25 µm Film Thickness x 15 m Length BP1 GC Capillary Column
054044	0.25 mm ID x 0.25 µm Film Thickness x 30 m Length BP1 GC Capillary Column
054045	0.25 mm ID x 0.25 µm Film Thickness x 60 m Length BP1 GC Capillary Column
054820	0.25 mm ID x 0.5 µm Film Thickness x 30 m Length BP1 GC Capillary Column
054812	0.25 mm ID x 0.5 µm Film Thickness x 60 m Length BP1 GC Capillary Column
054056	0.25 mm ID x 1 µm Film Thickness x 30 m Length BP1 GC Capillary Column
054815	0.25 mm ID x 1 µm Film Thickness x 60 m Length BP1 GC Capillary Column
054061	0.32 mm ID x 0.25 µm Film Thickness x 15 m Length BP1 GC Capillary Column
054059	0.32 mm ID x 0.25 µm Film Thickness x 25 m Length BP1 GC Capillary Column
054062	0.32 mm ID x 0.25 µm Film Thickness x 30 m Length BP1 GC Capillary Column
054064	0.32 mm ID x 0.5 µm Film Thickness x 12 m Length BP1 GC Capillary Column
054065	0.32 mm ID x 0.5 µm Film Thickness x 25 m Length BP1 GC Capillary Column
054068	0.32 mm ID x 0.5 µm Film Thickness x 30 m Length BP1 GC Capillary Column
054066	0.32 mm ID x 0.5 µm Film Thickness x 50 m Length BP1 GC Capillary Column
054069	0.32 mm ID x 0.5 µm Film Thickness x 60 m Length BP1 GC Capillary Column
054070	0.32 mm ID x 1 µm Film Thickness x 12 m Length BP1 GC Capillary Column
054071	0.32 mm ID x 1 µm Film Thickness x 25 m Length BP1 GC Capillary Column
054813	0.32 mm ID x 1 µm Film Thickness x 30 m Length BP1 GC Capillary Column
054072	0.32 mm ID x 1 µm Film Thickness x 50 m Length BP1 GC Capillary Column
054810	0.32 mm ID x 1 µm Film Thickness x 60 m Length BP1 GC Capillary Column
054073	0.32 mm ID x 3 µm Film Thickness x 30 m Length BP1 GC Capillary Column
054082	0.32 mm ID x 5 µm Film Thickness x 50 m Length BP1 GC Capillary Column
054085	0.32 mm ID x 5 µm Film Thickness x 60 m Length BP1 GC Capillary Column
054092	0.53 mm ID x 0.5 µm Film Thickness x 30 m Length BP1 GC Capillary Column
054086	0.53 mm ID x 1 µm Film Thickness x 12 m Length BP1 GC Capillary Column
054087	0.53 mm ID x 1 µm Film Thickness x 25 m Length BP1 GC Capillary Column
054090	0.53 mm ID x 1 µm Film Thickness x 30 m Length BP1 GC Capillary Column
054808	0.53 mm ID x 3 µm Film Thickness x 30 m Length BP1 GC Capillary Column
054809	0.53 mm ID x 3 µm Film Thickness x 60 m Length BP1 GC Capillary Column
054095	0.53 mm ID x 5 µm Film Thickness x 25 m Length BP1 GC Capillary Column
054806	0.53 mm ID x 5 µm Film Thickness x 30 m Length BP1 GC Capillary Column
054096	0.53 mm ID x 5 µm Film Thickness x 50 m Length BP1 GC Capillary Column
054807	0.53 mm ID x 5 µm Film Thickness x 60 m Length BP1 GC Capillary Column

For more information about this product visit [www.sge.com](http://www.sge.com) or contact [techsupport@sge.com](mailto:techsupport@sge.com).

## Separations | GC Column BP1 PONA

More than five decades of innovative phase technologies and unique fused silica production capabilities, together provide end-to-end separation solutions for all applications.

### Features and Benefits

- Designed for the analysis of petroleum products.
- Non-polar phase for PONA analysis.
- Detailed hydrocarbon analysis according to ASTM (DHA-method).
- Crosslinked and washable.
- Very high resolving power columns for complex samples.

### Recommended Applications

- Petroleum hydrocarbons.
- Gasoline range hydrocarbons.
- MTBE.
- Paraffins.
- Olefins.
- Napthalenes.
- Aromatics.

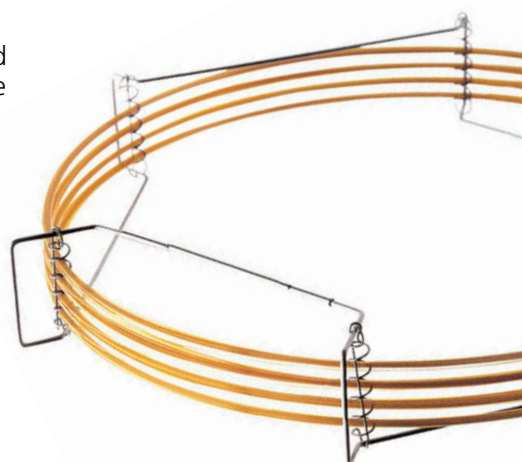

### Product Specifications

100% Dimethyl Polysiloxane. Suitable Replacement for: Petrocol DH, DB-Petro, HP-PONA, AT-Petro, Elite-PONA, ZB-1, 007-1-100-0.5F, Rtx-1PONA, CP Sil PONA.

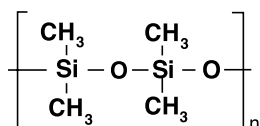

Film Thickness	Operating Temperature
0.5 μm	-60°C to 320/340 °C

For more information about this product visit [www.sge.com](http://www.sge.com) or contact [techsupport@sge.com](mailto:techsupport@sge.com).



## Separations | GC Column BP1 PONA

Part Number	Part Description and Detail
054950	0.15 mm ID x 0.5 µm Film Thickness x 50 m Length BP1-PONA GC Capillary Column
054818	0.25 mm ID x 0.5 µm Film Thickness x 100 m Length BP1-PONA GC Capillary Column

For more information about this product visit [www.sge.com](http://www.sge.com) or contact [techsupport@sge.com](mailto:techsupport@sge.com).

## Separations | GC Column BP10 (1701)

More than five decades of innovative phase technologies and unique fused silica production capabilities, together provide end-to-end separation solutions for all applications.

### Features and Benefits

- Used for organochlorine pesticides analysis.
- Bonded and cross-linked.
- Highly inert.
- Low bleed.
- Able to be solvent rinsed.

### Recommended Applications

- Environmental analysis (EPA methods 608, 8081).
- Pesticides/herbicides.
- Drugs of abuse.
- Pharmaceuticals.

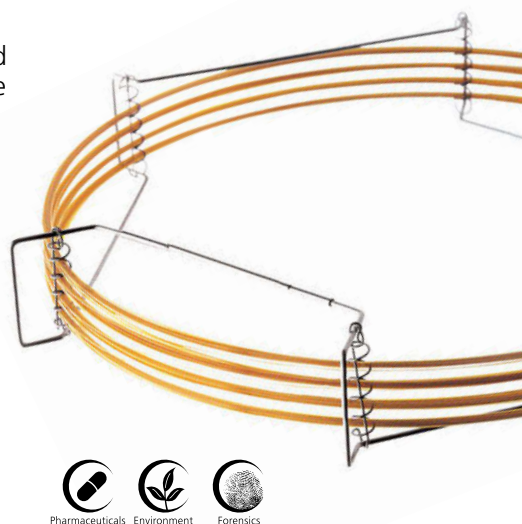

### Product Specifications

14% Cyanopropylphenyl Polysiloxane. Suitable replacement for: DB-1701, Rtx-1701, SPB-7, HP-1701, CP-Sil 19CB, 007-1701, PE-1701, SP-1701.

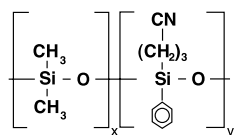

Film Thickness	Operating Temperature
0.25-0.50 $\mu\text{m}$	-20 $^{\circ}\text{C}$ to 280/300 $^{\circ}\text{C}$
1.0 $\mu\text{m}$	-20 $^{\circ}\text{C}$ to 260/280 $^{\circ}\text{C}$

For more information about this product visit [www.sge.com](http://www.sge.com) or contact [techsupport@sge.com](mailto:techsupport@sge.com).

## Separations | GC Column BP10 (1701)

Part Number	Part Description and Detail
054253	0.22 mm ID x 0.25 $\mu$ m Film Thickness x 25 m Length BP10 GC Capillary Column
054256	0.25 mm ID x 0.25 $\mu$ m Film Thickness x 30 m Length BP10 GC Capillary Column
054259	0.32 mm ID x 0.25 $\mu$ m Film Thickness x 30 m Length BP10 GC Capillary Column
054268	0.32 mm ID x 0.5 $\mu$ m Film Thickness x 25 m Length BP10 GC Capillary Column
054270	0.32 mm ID x 1.0 $\mu$ m Film Thickness x 30 m Length BP10 GC Capillary Column
054280	0.53 mm ID x 1.0 $\mu$ m Film Thickness x 25 m Length BP10 GC Capillary Column
054283	0.53 mm ID x 1.0 $\mu$ m Film Thickness x 30 m Length BP10 GC Capillary Column

For more information about this product visit [www.sge.com](http://www.sge.com) or contact [techsupport@sge.com](mailto:techsupport@sge.com).

## Separations | GC Column BP20 (WAX)

More than five decades of innovative phase technologies and unique fused silica production capabilities, together provide end-to-end separation solutions for all applications.

### Features and Benefits

- Industry standard Wax column.
- Bonded and cross-linked.
- Able to be solvent rinsed.

### Recommended Applications

- Alcohol.
- Free acids.
- FAME's.
- Aromatics.
- Solvents.
- Essential oils.

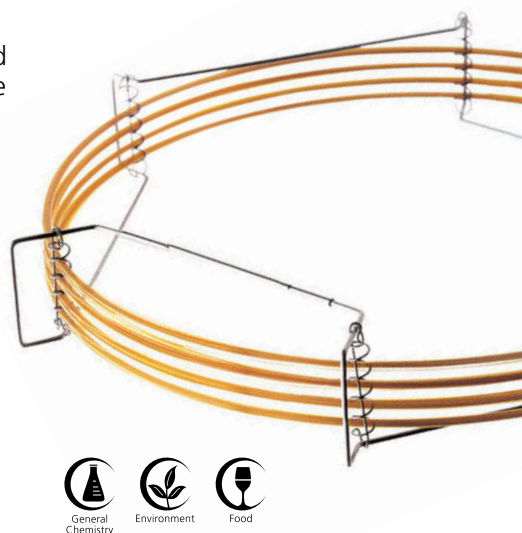

### Product Specifications

Polyethylene Glycol phase. Suitable replacement for: DB-Wax, HP-20M, Supelcowax 10, CB-Wax, Stabilwax, Carbowax, HP-Innowax, Rtx-WAX, PE-WAX, RH-WAX, ZB-WAX, TRWAX.

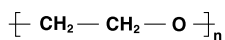

Film Thickness	Operating Temperature
0.1-1.0 $\mu\text{m}$	20 $^{\circ}\text{C}$ to 260/280 $^{\circ}\text{C}$
> 1.0 $\mu\text{m}$	20 $^{\circ}\text{C}$ to 240/260 $^{\circ}\text{C}$

For more information about this product visit [www.sge.com](http://www.sge.com) or contact [techsupport@sge.com](mailto:techsupport@sge.com).

## Separations | GC Column BP20 (WAX)

Part Number	Part Description and Detail
054405	0.1 mm ID x 0.1 µm Film Thickness x 10 m Length BP20 GC Capillary Column
054421	0.22 mm ID x 0.25 µm Film Thickness x 25 m Length BP20 GC Capillary Column
054424	0.22 mm ID x 0.25 µm Film Thickness x 30 m Length BP20 GC Capillary Column
054422	0.22 mm ID x 0.25 µm Film Thickness x 50 m Length BP20 GC Capillary Column
054425	0.22 mm ID x 0.25 µm Film Thickness x 60 m Length BP20 GC Capillary Column
054427	0.25 mm ID x 0.25 µm Film Thickness x 30 m Length BP20 GC Capillary Column
054428	0.25 mm ID x 0.25 µm Film Thickness x 60 m Length BP20 GC Capillary Column
054415	0.25 mm ID x 0.5 µm Film Thickness x 30 m Length BP20 GC Capillary Column
054458	0.25 mm ID x 0.5 µm Film Thickness x 60 m Length BP20 GC Capillary Column
054439	0.25 mm ID x 1.0 µm Film Thickness x 30 m Length BP20 GC Capillary Column
054433	0.32 mm ID x 0.25 µm Film Thickness x 30 m Length BP20 GC Capillary Column
054431	0.32 mm ID x 0.25 µm Film Thickness x 50 m Length BP20 GC Capillary Column
054434	0.32 mm ID x 0.25 µm Film Thickness x 60 m Length BP20 GC Capillary Column
054436	0.32 mm ID x 0.5 µm Film Thickness x 25 m Length BP20 GC Capillary Column
054438	0.32 mm ID x 0.5 µm Film Thickness x 30 m Length BP20 GC Capillary Column
054437	0.32 mm ID x 0.5 µm Film Thickness x 50 m Length BP20 GC Capillary Column
054457	0.32 mm ID x 0.5 µm Film Thickness x 60 m Length BP20 GC Capillary Column
054442	0.32 mm ID x 1.0 µm Film Thickness x 25 m Length BP20 GC Capillary Column
054444	0.32 mm ID x 1.0 µm Film Thickness x 30 m Length BP20 GC Capillary Column
054443	0.32 mm ID x 1.0 µm Film Thickness x 50 m Length BP20 GC Capillary Column
054445	0.32 mm ID x 1.0 µm Film Thickness x 60 m Length BP20 GC Capillary Column
054440	0.53 mm ID x 0.5 µm Film Thickness x 30 m Length BP20 GC Capillary Column
054450	0.53 mm ID x 1.0 µm Film Thickness x 15 m Length BP20 GC Capillary Column
054448	0.53 mm ID x 1.0 µm Film Thickness x 25 m Length BP20 GC Capillary Column
054451	0.53 mm ID x 1.0 µm Film Thickness x 30 m Length BP20 GC Capillary Column
0544515	0.53 mm ID x 1.0 µm Film Thickness x 60 m Length BP20 GC Capillary Column
054456	0.53 mm ID x 2.0 µm Film Thickness x 25 m Length BP20 GC Capillary Column

For more information about this product visit [www.sge.com](http://www.sge.com) or contact [techsupport@sge.com](mailto:techsupport@sge.com).

## Separations | GC Column BP21 (FFAP)

More than five decades of innovative phase technologies and unique fused silica production capabilities, together provide end-to-end separation solutions for all applications.

### Features and Benefits

- Polar phase.
- Ideal for low molecular weight acids.
- Able to be solvent rinsed.
- Bonded and cross-linked.

### Recommended Applications

- Volatile free acids.
- FAMES.
- Alcohols.
- Aldehydes.
- Acrylates.
- Ketones.

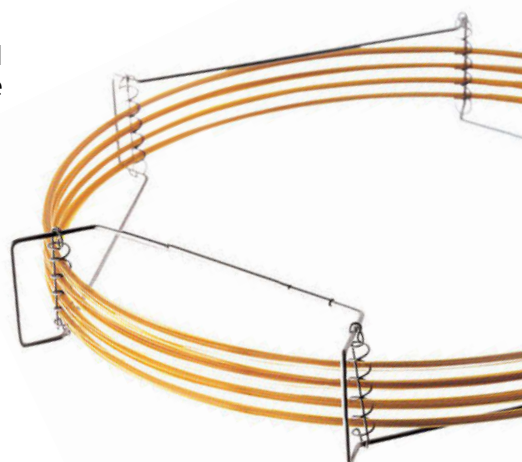

### Product Specifications

Nitroterephthalic acid modified PEG. Suitable Replacement for: DB-FFAP, HP-FFAP, Stabilwax-DA, CPWax-58CB.

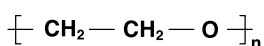

Film Thickness	Operating Temperature
0.25, 0.5, 1 $\mu\text{m}$	35 $^{\circ}\text{C}$ to 240/250 $^{\circ}\text{C}$

For more information about this product visit [www.sge.com](http://www.sge.com) or contact [techsupport@sge.com](mailto:techsupport@sge.com).

## Separations | GC Column BP21 (FFAP)

Part Number	Part Description and Detail
054462	0.22 mm ID x 0.25 µm Film Thickness x 25 m Length BP21 GC Capillary Column
054465	0.25 mm ID x 0.25 µm Film Thickness x 30 m Length BP21 GC Capillary Column
054466	0.25 mm ID x 0.25 µm Film Thickness x 60 m Length BP21 GC Capillary Column
054468	0.32 mm ID x 0.25 µm Film Thickness x 25 m Length BP21 GC Capillary Column
054471	0.32 mm ID x 0.25 µm Film Thickness x 30 m Length BP21 GC Capillary Column
054469	0.32 mm ID x 0.25 µm Film Thickness x 50 m Length BP21 GC Capillary Column
054472	0.32 mm ID x 0.25 µm Film Thickness x 60 m Length BP21 GC Capillary Column
054480	0.32 mm ID x 0.5 µm Film Thickness x 50 m Length BP21 GC Capillary Column
054474	0.53 mm ID x 0.5 µm Film Thickness x 25 m Length BP21 GC Capillary Column
054477	0.53 mm ID x 0.5 µm Film Thickness x 30 m Length BP21 GC Capillary Column
054478	0.53 mm ID x 1.0 µm Film Thickness x 30 m Length BP21 GC Capillary Column

For more information about this product visit [www.sge.com](http://www.sge.com) or contact [techsupport@sge.com](mailto:techsupport@sge.com).

## Separations | GC Column BP5

More than five decades of innovative phase technologies and unique fused silica production capabilities, together provide end-to-end separation solutions for all applications.

### Features and Benefits

- Excellent general purpose GC column.
- Low bleed.

### Recommended Applications

- General purpose.
- Aromatics.
- Pesticides.
- Herbicides.
- Drugs of abuse.
- Hydrocarbons.
- Solvent impurities.
- PCB congeners.
- Aroclor mixes.
- Essential oils.
- Semivolatiles.



### Product Specifications

5% Phenyl / 95% Dimethyl Polysiloxane. Suitable replacement for: DB-5, Rtx-5, HP-5, Ultra-2, PTE-5, SPB-5, MDN-5, CP-Sil 8CB, VB-5, ZB-5, VF-5ms.

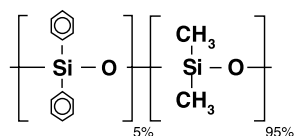

Film Thickness	Operating Temperature
0.25-1.5 $\mu\text{m}$	-60 $^{\circ}\text{C}$ to 320/340 $^{\circ}\text{C}$
> 1.5 $\mu\text{m}$	-60 $^{\circ}\text{C}$ to 280/300 $^{\circ}\text{C}$

For more information about this product visit [www.sge.com](http://www.sge.com) or contact [techsupport@sge.com](mailto:techsupport@sge.com).



## Separations | GC Column BP5

Part Number	Part Description and Detail
054167	0.22 mm ID x 0.25 µm Film Thickness x 12 m Length BP5 GC Capillary Column
054168	0.22 mm ID x 0.25 µm Film Thickness x 25 m Length BP5 GC Capillary Column
054182	0.25 mm ID x 0.25 µm Film Thickness x 15 m Length BP5 GC Capillary Column
054183	0.25 mm ID x 0.25 µm Film Thickness x 30 m Length BP5 GC Capillary Column
054184	0.25 mm ID x 0.25 µm Film Thickness x 60 m Length BP5 GC Capillary Column
054203	0.25 mm ID x 1.0 µm Film Thickness x 30 m Length BP5 GC Capillary Column
054180	0.32 mm ID x 0.25 µm Film Thickness x 25 m Length BP5 GC Capillary Column
054177	0.32 mm ID x 0.25 µm Film Thickness x 30 m Length BP5 GC Capillary Column
054178	0.32 mm ID x 0.25 µm Film Thickness x 60 m Length BP5 GC Capillary Column
054186	0.32 mm ID x 0.5 µm Film Thickness x 25 m Length BP5 GC Capillary Column
054216	0.32 mm ID x 0.5 µm Film Thickness x 30 m Length BP5 GC Capillary Column
054189	0.32 mm ID x 1.0 µm Film Thickness x 30 m Length BP5 GC Capillary Column
054188	0.32 mm ID x 1.0 µm Film Thickness x 60 m Length BP5 GC Capillary Column
054198	0.53 mm ID x 1.0 µm Film Thickness x 25 m Length BP5 GC Capillary Column
054195	0.53 mm ID x 1.0 µm Film Thickness x 30 m Length BP5 GC Capillary Column
054199	0.53 mm ID x 1.5 µm Film Thickness x 15 m Length BP5 GC Capillary Column
054196	0.53 mm ID x 5.0 µm Film Thickness x 30 m Length BP5 GC Capillary Column

For more information about this product visit [www.sge.com](http://www.sge.com) or contact [techsupport@sge.com](mailto:techsupport@sge.com).

## Separations | GC Column BP5MS

More than five decades of innovative phase technologies and unique fused silica production capabilities, together provide end-to-end separation solutions for all applications.

### Features and Benefits

- Perfect for your 5% MS analysis.
- Optimized Silphenylene content for general purpose MS analyses.
- Low bleed.
- Great inertness.

### Recommended Applications

5% MS analyses.

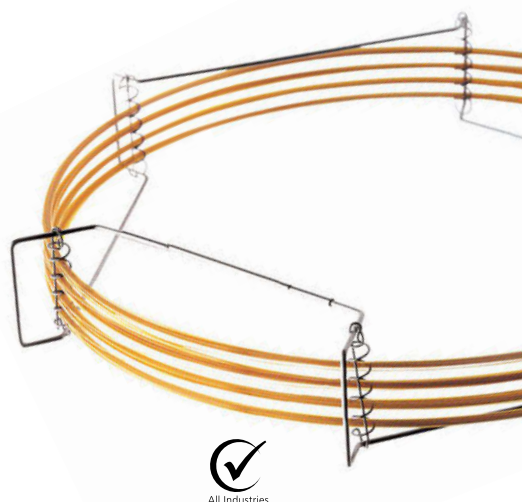

### Product Specifications

5% Phenyl Polysilphenylene-siloxane. Suitable replacement for: DB-5ms, ZB-5ms, Rxi-5Sil MS, VF-5ms, CP-Sil 8 CB.

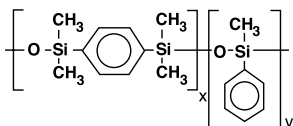

Film Thickness	Operating Temperature
0.1, 0.18, 0.25 $\mu\text{m}$	-40 $^{\circ}\text{C}$ to 330/350 $^{\circ}\text{C}$

For more information about this product visit [www.sge.com](http://www.sge.com) or contact [techsupport@sge.com](mailto:techsupport@sge.com).

## Separations | GC Column BP5MS

Part Number	Part Description and Detail
054301	0.18 mm ID x 0.18 $\mu$ m Film Thickness x 20 m Length BP5MS GC Capillary Column
054312	0.25 mm ID x 0.1 $\mu$ m Film Thickness x 60 m Length BP5MS GC Capillary Column
054308	0.25 mm ID x 0.25 $\mu$ m Film Thickness x 15 m Length BP5MS GC Capillary Column
054310	0.25 mm ID x 0.25 $\mu$ m Film Thickness x 30 m Length BP5MS GC Capillary Column
054320	0.32 mm ID x 0.25 $\mu$ m Film Thickness x 30 m Length BP5MS GC Capillary Column
054321	0.32 mm ID x 0.25 $\mu$ m Film Thickness x 60 m Length BP5MS GC Capillary Column

For more information about this product visit [www.sge.com](http://www.sge.com) or contact [techsupport@sge.com](mailto:techsupport@sge.com).

## Separations | GC Column BP624

More than five decades of innovative phase technologies and unique fused silica production capabilities, together provide end-to-end separation solutions for all applications.

### Features and Benefits

- US EPA 624 optimized column.
- Designed for volatiles analysis.
- Able to be solvent rinsed.
- Bonded and cross-linked.

### Recommended Applications

- EPA method 624, USP G43 methods, SW-846 and 8240/8260 methods.
- Drinking water volatiles.
- Chlorinated hydrocarbons.
- Solvents.

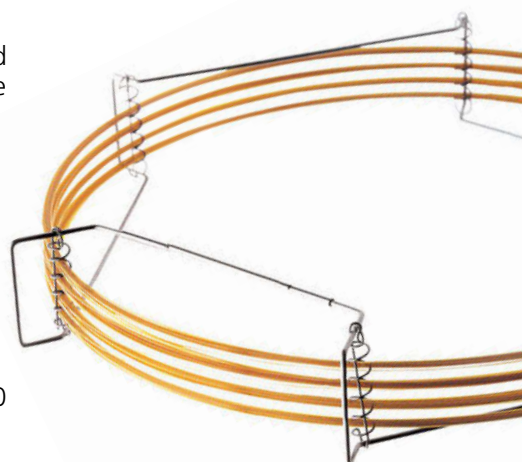

Environment

### Product Specifications

Cyanopropylphenyl Polysiloxane. Suitable replacement for: DB-624, OV-624, AT-624, HP-VOC, CP-Select624CB, 007-624, Rtx-Volatiles, VOCOL, ZB-624.

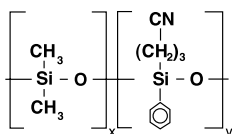

Film Thickness	Operating Temperature
1.2, 1.4, 1.8, 3 μm	0 °C to 230/240 °C

For more information about this product visit [www.sge.com](http://www.sge.com) or contact [techsupport@sge.com](mailto:techsupport@sge.com).

## Separations | GC Column BP624

Part Number	Part Description and Detail
054827	0.22 mm ID x 1.2 $\mu$ m Film Thickness x 30 m Length BP624 GC Capillary Column
054839	0.25 mm ID x 1.4 $\mu$ m Film Thickness x 15 m Length BP624 GC Capillary Column
054840	0.25 mm ID x 1.4 $\mu$ m Film Thickness x 30 m Length BP624 GC Capillary Column
054842	0.25 mm ID x 1.4 $\mu$ m Film Thickness x 60 m Length BP624 GC Capillary Column
054832	0.32 mm ID x 1.8 $\mu$ m Film Thickness x 30 m Length BP624 GC Capillary Column
054841	0.32 mm ID x 1.8 $\mu$ m Film Thickness x 60 m Length BP624 GC Capillary Column
054836	0.53 mm ID x 3.0 $\mu$ m Film Thickness x 30 m Length BP624 GC Capillary Column
054835	0.53 mm ID x 3.0 $\mu$ m Film Thickness x 50 m Length BP624 GC Capillary Column
054838	0.53 mm ID x 3.0 $\mu$ m Film Thickness x 60 m Length BP624 GC Capillary Column

For more information about this product visit [www.sge.com](http://www.sge.com) or contact [techsupport@sge.com](mailto:techsupport@sge.com).

## Separations | GC Column BPX1

More than five decades of innovative phase technologies and unique fused silica production capabilities, together provide end-to-end separation solutions for all applications.

### Features and Benefits

- Non-polar column.
- Dimensionally stabilized phase.
- Low bleed.
- Specifically designed for high temperature hydrocarbon analysis.

### Recommended Applications

ASTM methods D2887 and D6532.

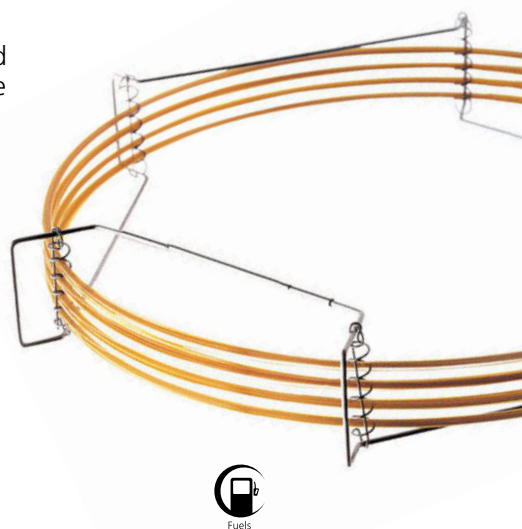

### Product Specifications

100% Dimethyl Polysiloxane. Suitable Replacement for: DB-2887, DB-HT Sim Dis, HP-1, Petrocol 2887, Petrocol EX2887, Rtx-2887.

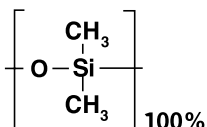

Film Thickness	Operating Temperature
Aluminum Clad 0.1 $\mu\text{m}$	30 $^{\circ}\text{C}$ to 430 $^{\circ}\text{C}$
Polyimide Clad 0.1-0.9 $\mu\text{m}$	30 $^{\circ}\text{C}$ to 400 $^{\circ}\text{C}$
2.65 $\mu\text{m}$	30 $^{\circ}\text{C}$ to 370 $^{\circ}\text{C}$

For more information about this product visit [www.sge.com](http://www.sge.com) or contact [techsupport@sge.com](mailto:techsupport@sge.com).

## Separations | GC Column BPX1

Part Number	Part Description and Detail
054777	0.1 mm ID x 0.1 $\mu$ m Film Thickness x 10 m Length BPX1 GC Capillary Column
054803	0.53 mm ID x 0.1 $\mu$ m Film Thickness x 10 m Length BPX1 GC Capillary Column
054800	0.53 mm ID x 0.1 $\mu$ m Film Thickness x 5 m Length BPX1- Simulated Distillation GC Capillary Column (Aluminium Clad)
054801	0.53 mm ID x 0.9 $\mu$ m Film Thickness x 10 m Length BPX1- Simulated Distillation GC Capillary Column
0548025	0.53 mm ID x 2.65 $\mu$ m Film Thickness x 6 m Length BPX1- Simulated Distillation GC Capillary Column
054802	0.53 mm ID x 2.65 $\mu$ m Film Thickness x 10 m Length BPX1- Simulated Distillation GC Capillary Column

For more information about this product visit [www.sge.com](http://www.sge.com) or contact [techsupport@sge.com](mailto:techsupport@sge.com).

## Separations | GC Column BPX35

More than five decades of innovative phase technologies and unique fused silica production capabilities, together provide end-to-end separation solutions for all applications.

### Features and Benefits

- Mid polarity column. Ideal for confirmational analysis.
- Inert.
- Equivalent to USP phase G42.
- High temperature.
- Very low bleed.
- Pharmaceutical specialist.
- Bonded and cross-linked. Able to be solvent rinsed.

### Recommended Applications

- Environmental analyses.
- Pesticides/herbicides.
- Drugs of abuse.
- Pharmaceuticals.
- Polynuclear aromatic hydrocarbons.
- GC/MS applications.

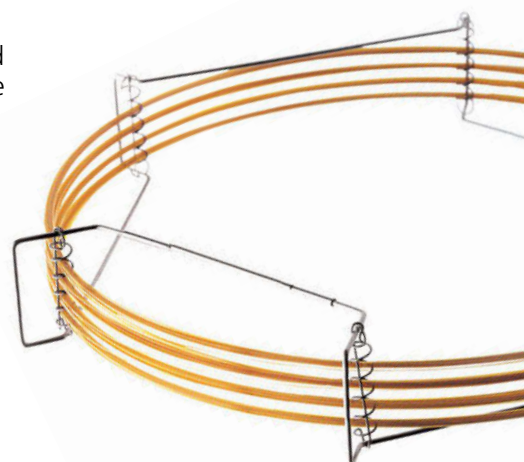

### Product Specifications

35% Phenyl Polysilphenylene-siloxane. Suitable Replacement for: DB-35, DB-35ms, Rtx-35, HP-35, HP-35MS, SPB-35, MDN-35.

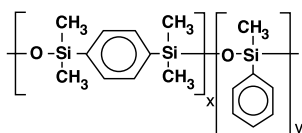

Film Thickness	Operating Temperature
0.1, 0.25, 0.5, 1 μm	10 °C to 330/360 °C

For more information about this product visit [www.sge.com](http://www.sge.com) or contact [techsupport@sge.com](mailto:techsupport@sge.com).



## Separations | GC Column BPX35

Part Number	Part Description and Detail
054699	0.1 mm ID x 0.1 $\mu$ m Film Thickness x 10 m Length BPX35 GC Capillary Column
054711	0.22 mm ID x 0.25 $\mu$ m Film Thickness x 25 m Length BPX35 GC Capillary Column
054701	0.25 mm ID x 0.25 $\mu$ m Film Thickness x 30 m Length BPX35 GC Capillary Column
054702	0.25 mm ID x 0.25 $\mu$ m Film Thickness x 60 m Length BPX35 GC Capillary Column
054724	0.32 mm ID x 0.25 $\mu$ m Film Thickness x 30 m Length BPX35 GC Capillary Column
0547158	0.32 mm ID x 0.5 $\mu$ m Film Thickness x 30 m Length BPX35 GC Capillary Column
054737	0.53 mm ID x 1.0 $\mu$ m Film Thickness x 30 m Length BPX35 GC Capillary Column

For more information about this product visit [www.sge.com](http://www.sge.com) or contact [techsupport@sge.com](mailto:techsupport@sge.com).

## Separations | GC Column BPX5

More than five decades of innovative phase technologies and unique fused silica production capabilities, together provide end-to-end separation solutions for all applications.

### Features and Benefits

- High temperature.
- General purpose GC column (suitable for over 80% routine GC analyses).
- Very low bleed – ideal for trace analysis.
- Non-polar.
- Extremely inert.
- Ideal for GC-MS.

### Recommended Applications

- Ultra trace analyses.
- Pesticides.
- Herbicides.
- Hydrocarbons.
- Solvents.
- Phenols.
- Amines.

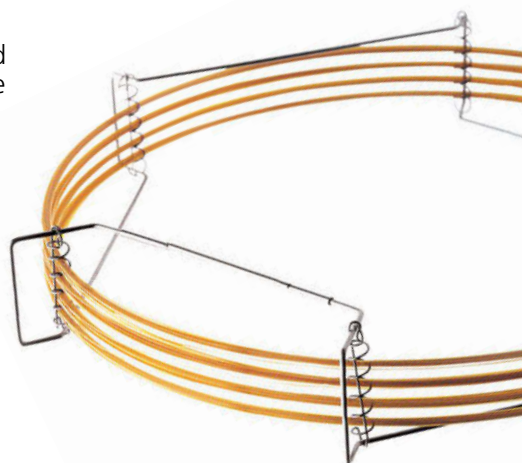

All Industries

### Product Specifications

5% Phenyl / 95% Dimethyl Polysiloxane (equivalent). Suitable replacement for: DB-5, DB-5ms, DB-5.625, XTI-5, Rtx-5ms, Ultra-2, HP-5, HP-5MS, HP5-TA, SPB-5, MDN-5S, CP-Sil8CB, Rxt-Sil 5MS, AT-5ms, VB-5, ZB-5, VF-5ms.

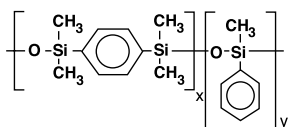

GC Column Dimensions (mm)	Film Thickness	Operating Temperature
0.1, 0.15, 0.18, 0.22, 0.25, 0.32, 0.53	0.25-1.5 $\mu\text{m}$	-40 $^{\circ}\text{C}$ to 360/370 $^{\circ}\text{C}$
	>1.5 $\mu\text{m}$	-40 $^{\circ}\text{C}$ to 350/360 $^{\circ}\text{C}$

For more information about this product visit [www.sge.com](http://www.sge.com) or contact [techsupport@sge.com](mailto:techsupport@sge.com).

## Separations | GC Column BPX5

Part Number	Part Description and Detail
054099	0.1 mm ID x 0.1 µm Film Thickness x 10 m Length BPX5 GC Capillary Column
054110	0.15 mm ID x 0.15 µm Film Thickness x 30 m Length BPX5 GC Capillary Column
054104	0.15 mm ID x 0.25 µm Film Thickness x 25 m Length BPX5 GC Capillary Column
054229	0.18 mm ID x 0.18 µm Film Thickness x 40 m Length BPX5 GC Capillary Column
054112	0.22 mm ID x 0.25 µm Film Thickness x 12 m Length BPX5 GC Capillary Column
054113	0.22 mm ID x 0.25 µm Film Thickness x 25 m Length BPX5 GC Capillary Column
054142	0.22 mm ID x 0.25 µm Film Thickness x 30 m Length BPX5 GC Capillary Column
054114	0.22 mm ID x 0.25 µm Film Thickness x 50 m Length BPX5 GC Capillary Column
0542170	0.25 mm ID x 0.1 µm Film Thickness x 15 m Length BPX5 GC Capillary Column
0541011	0.25 mm ID x 0.1 µm Film Thickness x 30 m Length BPX5 GC Capillary Column
054149	0.25 mm ID x 0.25µm Film Thickness x 7 m Length BPX5 GC Capillary Column (Uncaged)
054100	0.25 mm ID x 0.25 µm Film Thickness x 15 m Length BPX5 GC Capillary Column
054101	0.25 mm ID x 0.25 µm Film Thickness x 30 m Length BPX5 GC Capillary Column
054102	0.25 mm ID x 0.25 µm Film Thickness x 60 m Length BPX5 GC Capillary Column
0541025	0.25 mm ID x 0.5 µm Film Thickness x 30 m Length BPX5 GC Capillary Column
054121	0.25 mm ID x 1.0 µm Film Thickness x 15 m Length BPX5 GC Capillary Column
054122	0.25 mm ID x 1.0 µm Film Thickness x 30 m Length BPX5 GC Capillary Column
054123	0.25 mm ID x 1.0 µm Film Thickness x 60 m Length BPX5 GC Capillary Column
054118	0.32 mm ID x 0.25 µm Film Thickness x 12 m Length BPX5 GC Capillary Column
054144	0.32 mm ID x 0.25 µm Film Thickness x 15 m Length BPX5 GC Capillary Column
054119	0.32 mm ID x 0.25 µm Film Thickness x 25 m Length BPX5 GC Capillary Column
054145	0.32 mm ID x 0.25 µm Film Thickness x 30 m Length BPX5 GC Capillary Column
054146	0.32 mm ID x 0.25 µm Film Thickness x 60 m Length BPX5 GC Capillary Column
054124	0.32 mm ID x 0.5 µm Film Thickness x 12 m Length BPX5 GC Capillary Column
054125	0.32 mm ID x 0.5 µm Film Thickness x 25 m Length BPX5 GC Capillary Column
0541205	0.32 mm ID x 0.5 µm Film Thickness x 30 m Length BPX5 GC Capillary Column
054126	0.32 mm ID x 0.5 µm Film Thickness x 50 m Length BPX5 GC Capillary Column
0541261	0.32 mm ID x 1.0 µm Film Thickness x 6 m Length BPX5 GC Capillary Column
054127	0.32 mm ID x 1.0 µm Film Thickness x 12 m Length BPX5 GC Capillary Column
054153	0.32 mm ID x 1.0 µm Film Thickness x 30 m Length BPX5 GC Capillary Column
054129	0.32 mm ID x 1.0 µm Film Thickness x 50 m Length BPX5 GC Capillary Column
054154	0.32 mm ID x 1.0 µm Film Thickness x 60 m Length BPX5 GC Capillary Column
054133	0.53 mm ID x 0.25 µm Film Thickness x 12 m Length BPX5 GC Capillary Column
054134	0.53 mm ID x 0.25 µm Film Thickness x 25 m Length BPX5 GC Capillary Column
0541345	0.53 mm ID x 0.5 µm Film Thickness x 30 m Length BPX5 GC Capillary Column
054130	0.53 mm ID x 1.0 µm Film Thickness x 12 m Length BPX5 GC Capillary Column
054131	0.53 mm ID x 1.0 µm Film Thickness x 25 m Length BPX5 GC Capillary Column
054148	0.53 mm ID x 1.0 µm Film Thickness x 30 m Length BPX5 GC Capillary Column
0541348	0.53 mm ID x 1.5 µm Film Thickness x 30 m Length BPX5 GC Capillary Column
054139	0.53 mm ID x 3.0 µm Film Thickness x 25 m Length BPX5 GC Capillary Column
054160	0.53 mm ID x 3.0 µm Film Thickness x 30 m Length BPX5 GC Capillary Column

For more information about this product visit [www.sge.com](http://www.sge.com) or contact [techsupport@sge.com](mailto:techsupport@sge.com).

## Separations | GC Column BPX50

More than five decades of innovative phase technologies and unique fused silica production capabilities, together provide end-to-end separation solutions for all applications.

### Features and Benefits

- Ideal for a range of EPA methods and pharmaceutical applications.
- Bonded and cross-linked. Able to be solvent rinsed.

### Recommended Applications

- EPA methods 604, 608, 8060, 8081.
- Triazines/herbicides.
- Drug screening.
- Steroids.
- A variety of pharmaceutical applications GC2D.

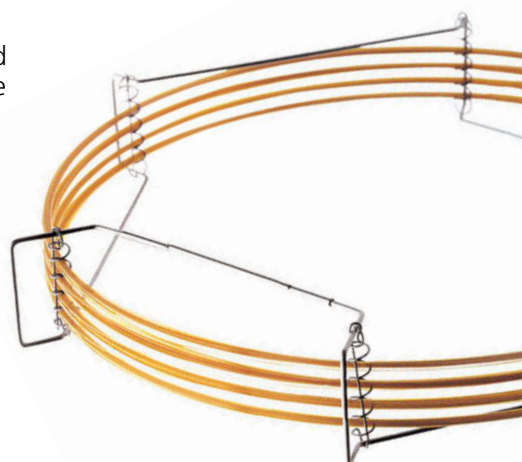

### Product Specifications

50% Phenyl Polysilphenylene-siloxane. Suitable replacement for: OV-17, SP-2250, DB-17, DB-17ms, DB-17ht, Rtx-50, SPB-50, HP-50+, HP-17.

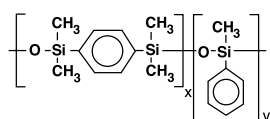

Film Thickness	Operating Temperature
0.1 to 1.0 $\mu\text{m}$	80 $^{\circ}\text{C}$ to 330/350 $^{\circ}\text{C}$

For more information about this product visit [www.sge.com](http://www.sge.com) or contact [techsupport@sge.com](mailto:techsupport@sge.com).

## Separations | GC Column BPX50

Part Number	Part Description and Detail
054740	0.1 mm ID x 0.1 µm Film Thickness x 10 m Length BPX50 GC Capillary Column
054741	0.15 mm ID x 0.15 µm Film Thickness x 30 m Length BPX50 GC Capillary Column
054742	0.18 mm ID x 0.18 µm Film Thickness x 20 m Length BPX50 GC Capillary Column
054750	0.25 mm ID x 0.25 µm Film Thickness x 15 m Length BPX50 GC Capillary Column
054751	0.25 mm ID x 0.25 µm Film Thickness x 30 m Length BPX50 GC Capillary Column
054752	0.25 mm ID x 0.25 µm Film Thickness x 60 m Length BPX50 GC Capillary Column
054761	0.32 mm ID x 0.25 µm Film Thickness x 30 m Length BPX50 GC Capillary Column
054772	0.53 mm ID x 1.0 µm Film Thickness x 30 m Length BPX50 GC Capillary Column

For more information about this product visit [www.sge.com](http://www.sge.com) or contact [techsupport@sge.com](mailto:techsupport@sge.com).

## Separations | GC Column BPX608

More than five decades of innovative phase technologies and unique fused silica production capabilities, together provide end-to-end separation solutions for all applications.

### Features and Benefits

- 35% Phenyl Polysilphenylene-siloxane optimized for ECD.
- Ideal for organochlorine, pesticides and herbicides analysis.

### Recommended Applications

- Environmental analyses.
- EPA 608, pesticides/herbicides.

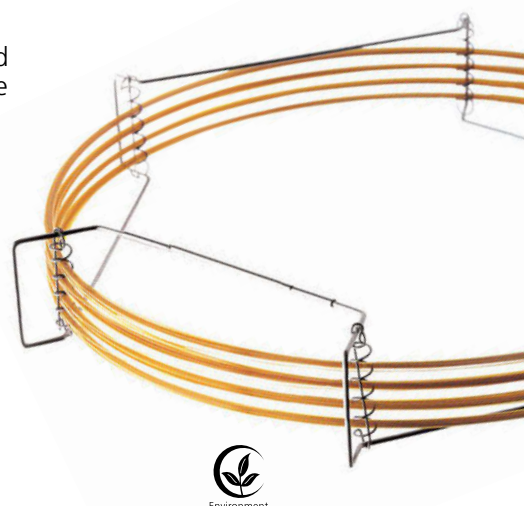

### Product Specifications

35% Phenyl Polysilphenylene-siloxane. Suitable replacement for: DB-608, Rtx-35, SPB-608, HP-35, ZB-35.

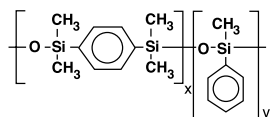

Film Thickness	Operating Temperature
0.4 μm	10 °C to 360/370 °C

For more information about this product visit [www.sge.com](http://www.sge.com) or contact [techsupport@sge.com](mailto:techsupport@sge.com).

## Separations | GC Column BPX608

Part Number	Part Description and Detail
054823	0.32 mm ID x 0.4 µm Film Thickness x 25 m Length BPX608 GC Capillary Column

For more information about this product visit [www.sge.com](http://www.sge.com) or contact [techsupport@sge.com](mailto:techsupport@sge.com).

## Separations | GC Column BPX70

More than five decades of innovative phase technologies and unique fused silica production capabilities, together provide end-to-end separation solutions for all applications.

### Features and Benefits

- Industry standard column for FAME analysis.
- Bonded and cross-linked. Able to be solvent rinsed.
- Long operating life.

### Recommended Applications

- Fatty acid methyl esters (FAMES).
- Carbohydrates.
- Pharmaceuticals.
- GC/MS applications.

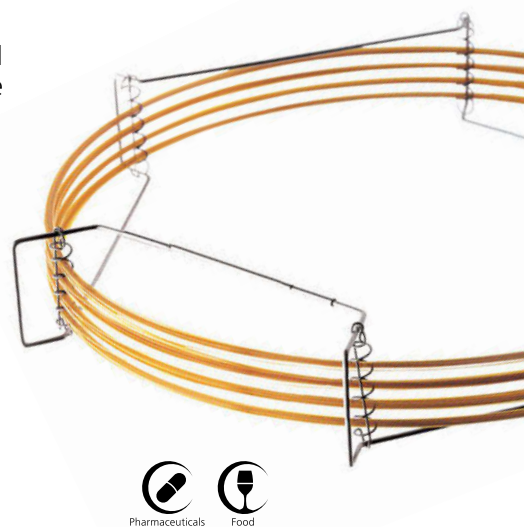

### Product Specifications

70% Cyanopropyl Polysilphenylene-siloxane. Suitable alternative to: DB-23, Rtx-2330, SP-2330, CP-Sil 88, SP2380, HP-23.

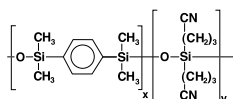

Film Thickness	Operating Temperature
0.2 to 0.5 $\mu\text{m}$	50 $^{\circ}\text{C}$ to 250/260 $^{\circ}\text{C}$

For more information about this product visit [www.sge.com](http://www.sge.com) or contact [techsupport@sge.com](mailto:techsupport@sge.com).



## Separations | GC Column BPX70

Part Number	Part Description and Detail
054600	0.1 mm ID x 0.2 µm Film Thickness x 10 m Length BPX70 GC Capillary Column
054602	0.22 mm ID x 0.25 µm Film Thickness x 25 m Length BPX70 GC Capillary Column
054612	0.22 mm ID x 0.25 µm Film Thickness x 30 m Length BPX70 GC Capillary Column
054603	0.22 mm ID x 0.25 µm Film Thickness x 50 m Length BPX70 GC Capillary Column
054613	0.22 mm ID x 0.25 µm Film Thickness x 60 m Length BPX70 GC Capillary Column
054621	0.25 mm ID x 0.25 µm Film Thickness x 15 m Length BPX70 GC Capillary Column
054622	0.25 mm ID x 0.25 µm Film Thickness x 30 m Length BPX70 GC Capillary Column
054623	0.25 mm ID x 0.25 µm Film Thickness x 60 m Length BPX70 GC Capillary Column
054624	0.25 mm ID x 0.25 µm Film Thickness x 120 m Length BPX70 GC Capillary Column
054606	0.32 mm ID x 0.25 µm Film Thickness x 25 m Length BPX70 GC Capillary Column
054616	0.32 mm ID x 0.25 µm Film Thickness x 30 m Length BPX70 GC Capillary Column
054607	0.32 mm ID x 0.25 µm Film Thickness x 50 m Length BPX70 GC Capillary Column
054617	0.32 mm ID x 0.25 µm Film Thickness x 60 m Length BPX70 GC Capillary Column
054620	0.53 mm ID x 0.5 µm Film Thickness x 30 m Length BPX70 GC Capillary Column

For more information about this product visit [www.sge.com](http://www.sge.com) or contact [techsupport@sge.com](mailto:techsupport@sge.com).

## Separations | GC Column BPX90

More than five decades of innovative phase technologies and unique fused silica production capabilities, together provide end-to-end separation solutions for all applications.

### Features and Benefits

- Unique bonded phase.
- Highly polar.
- Thermally stable.
- Excellent resolution for cis and trans isomers.
- Able to be solvent rinsed.

### Recommended Applications

- Ideal for fast separation of fragrances.
- Aromatics.
- Petrochemical.
- Pesticides.
- PCB's.
- Isomers of Fatty Acid Methyl Esters (FAMES).

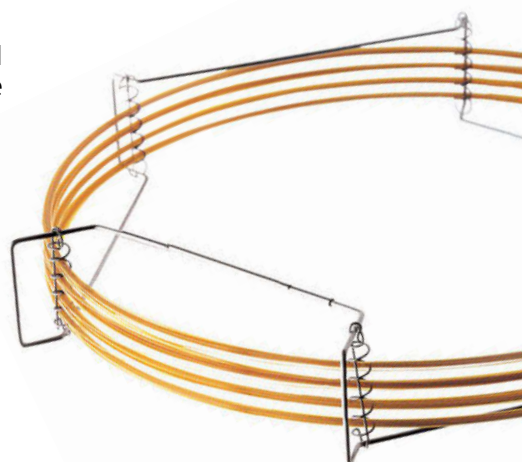

### Product Specifications

90% Cyanopropyl Polysilphenylene-siloxane. Suitable replacement for: unique to SGE.

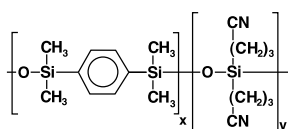

Film Thickness	Operating Temperature
0.25, 0.5 μm	80 °C to 260/280 °C

For more information about this product visit [www.sge.com](http://www.sge.com) or contact [techsupport@sge.com](mailto:techsupport@sge.com).

## Separations | GC Column BPX90

Part Number	Part Description and Detail
054570	0.25 mm ID x 0.25 $\mu$ m Film Thickness x 15 m Length BPX90 GC Capillary Column
054580	0.25 mm ID x 0.25 $\mu$ m Film Thickness x 30 m Length BPX90 GC Capillary Column
054590	0.25 mm ID x 0.25 $\mu$ m Film Thickness x 60 m Length BPX90 GC Capillary Column
054596	0.25 mm ID x 0.25 $\mu$ m Film Thickness x 100 m Length BPX90 GC Capillary Column
054583	0.32 mm ID x 0.5 $\mu$ m Film Thickness x 30 m Length BPX90 GC Capillary Column

For more information about this product visit [www.sge.com](http://www.sge.com) or contact [techsupport@sge.com](mailto:techsupport@sge.com).

## Separations | GC Column BPX-BIOD

More than five decades of innovative phase technologies and unique fused silica production capabilities, together provide end-to-end separation solutions for all applications.

### Features and Benefits

Optimized for specified ASTM and EN Biodiesel methods.

### Recommended Applications

ASTM and EN biodiesel methods (ASTM D6584, EN14110, EN14105, and EN14103).

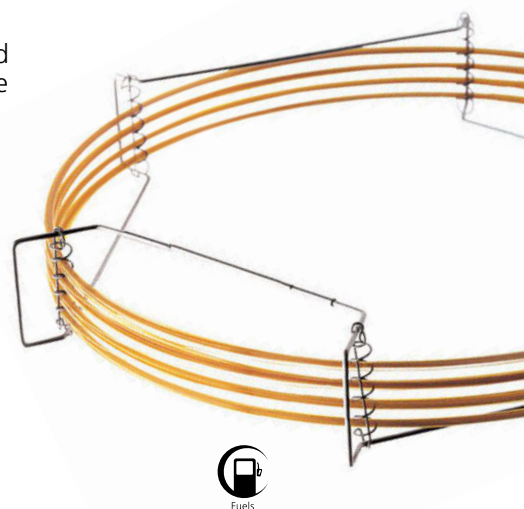

### Product Specifications

Each BPX-BIOD GC column is tested at the maximum operating temperature for the column, and specific tests are undertaken to ensure the column meets inertness specifications and separation performance. This means you can be confident of a reliable separation, column after column. ASTM D6584 / EN 14105, EN 14103, EN 14110.

Method	Description	Column ID	Length (m)	Film Thickness (µm)
ASTM D6584*¥	BPX – BIOD6584	0.32	10	0.1
ASTM D6584*¥	BPX – BIOD6584	0.32	15	0.1
EN14103*	BPX – BIOD20	0.32	30	0.25
EN14105*¥	BPX – BIOD5	0.32	10	0.1
EN14110**	BPX - BIOD Wax	0.32	30	0.25
EN14110**	BPX - BIOD Wax	0.32	30	1

\*Recommended column in method

\*\*Alternative column recommended in method

¥ Includes guard column

For more information about this product visit [www.sge.com](http://www.sge.com) or contact [techsupport@sge.com](mailto:techsupport@sge.com).

## Separations | GC Column BPX-BIOD

Part Number	Part Description and Detail
05411805G53	0.32 mm ID x 0.1 $\mu$ m Film Thickness x 10 m Length BPX-BIOD6584 with Guard Column
05411801SG53	0.32 mm ID x 0.1 $\mu$ m Film Thickness x 10 m Length BPX-BIOD5 with Guard Column
054640	0.32 mm ID x 0.1 $\mu$ m Film Thickness x 12 m Length Biodiesel HT5 GC Capillary Column
0541181SG53	0.32 mm ID x 0.1 $\mu$ m Film Thickness x 15 m Length BPX-BIOD6584 with Guard Column
0544331	0.32 mm ID x 0.25 $\mu$ m Film Thickness x 30 m Length BPX-Biodiesel 20 GC Capillary Column
0544332	0.32 mm ID x 0.25 $\mu$ m Film Thickness x 30 m Length BPX-Biodiesel Wax GC Capillary Column
0544441	0.32 mm ID x 1.0 $\mu$ m Film Thickness x 30 m Length BPX-Biodiesel Wax GC Capillary Column

For more information about this product visit [www.sge.com](http://www.sge.com) or contact [techsupport@sge.com](mailto:techsupport@sge.com).

## Separations | GC Column BPX-DXN

More than five decades of innovative phase technologies and unique fused silica production capabilities, together provide end-to-end separation solutions for all applications.

### Features and Benefits

- High temperature.
- Very low bleed – ideal for trace analysis.
- Non-polar.
- Extremely inert.
- Ideal for GC-MS.

### Recommended Applications

Dioxins and related compounds (POPs, PCBs, PCDFs, PCDDs).



---

### Product Specifications

Suitable replacement for: no equivalents, unique high temperature column.  
Operating temperature: -40 °C to 360/370 °C.

For more information about this product visit [www.sge.com](http://www.sge.com) or contact [techsupport@sge.com](mailto:techsupport@sge.com).

## Separations | GC Column BPX-DXN

Part Number	Part Description and Detail
054235	0.25 mm ID x 0.25 µm Film Thickness x 60 m Length BPX-Dioxin GC Capillary Column

For more information about this product visit [www.sge.com](http://www.sge.com) or contact [techsupport@sge.com](mailto:techsupport@sge.com).

## Separations | GC Column BPX-PCB

More than five decades of innovative phase technologies and unique fused silica production capabilities, together provide end-to-end separation solutions for all applications.

### Features and Benefits

- Preferred column for polychlorinated biphenyl (PCB) compounds.
- Separates PCB's on ortho ring substitution as well as boiling point.
- Ideal for environmental analysis.
- Unique high temperature phase suited for the analysis of persistent organic pollutants (POPs).

### Recommended Applications

- PCB congener analyses.
- Nitro-substituted aromatics.
- Polynuclear aromatic hydrocarbons.
- Pesticides/herbicides.

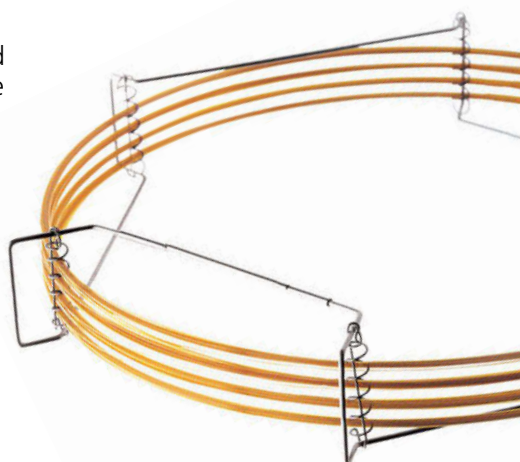

---

### Product Specifications

8% Phenyl Polycarborane-siloxane. Suitable replacement for: no equivalents, unique ultra high temperature column. Operating temperature: -20 °C to 360/370 °C

For more information about this product visit [www.sge.com](http://www.sge.com) or contact [techsupport@sge.com](mailto:techsupport@sge.com).



## Separations | GC Column BPX-PCB

Part Number	Part Description and Detail
054690	0.1 mm ID x 0.1 $\mu$ m Film Thickness x 10 m Length Fast PCB GC Capillary Column
054236	0.25 mm ID x 60 m Length HT8-PCB GC Capillary Column

For more information about this product visit [www.sge.com](http://www.sge.com) or contact [techsupport@sge.com](mailto:techsupport@sge.com).

## Separations | GC Column BPX-VOLATILES

More than five decades of innovative phase technologies and unique fused silica production capabilities, together provide end-to-end separation solutions for all applications.

### Features and Benefits

- Polar phase.
- EPA volatile organics analysis (EPA 624, 502.2, SW-846 8240/8260).
- Able to be solvent rinsed.
- Bonded and cross-linked.

### Recommended Applications

- Environmental analyses.
- Volatile organics.
- Alcohol analyses.
- USP G43.
- EPA 624, 502.2, SW-846 8240/8260.

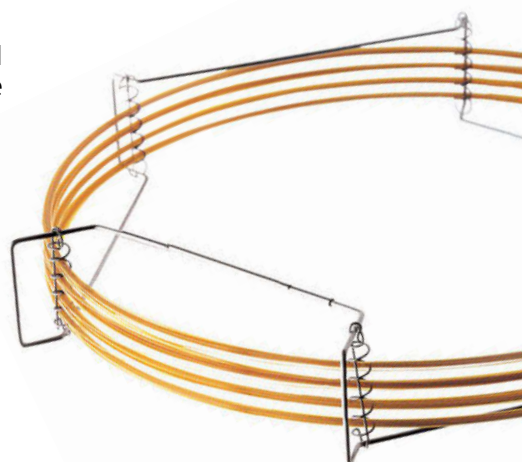

### Product Specifications

Cyanopropyl Polysilphenylene. Suitable replacement for: DB-VRX, HP-624, OPTIMA 624, ELITE-624, 007-624, RTX-VOLATILES, SPB-624, TRV1, CPSIL 13 CB, VOCOL, VB-624, CP-624.

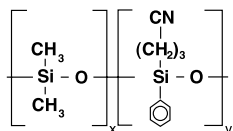

Film Thickness	Operating Temperature
1, 1.4, 1.8, 3 μm	0°C to 290/300 °C

For more information about this product visit [www.sge.com](http://www.sge.com) or contact [techsupport@sge.com](mailto:techsupport@sge.com).

## Separations | GC Column BPX-VOLATILES

Part Number	Part Description and Detail
054980	0.25 mm ID x 1.4 µm Film Thickness x 30 m Length BPX-Volatiles GC Capillary Column
054981	0.25 mm ID x 1.4 µm Film Thickness x 60 m Length BPX-Volatiles GC Capillary Column
054982	0.32 mm ID x 1.8 µm Film Thickness x 30 m Length BPX-Volatiles GC Capillary Column
054983	0.32 mm ID x 1.8 µm Film Thickness x 60 m Length BPX-Volatiles GC Capillary Column
054984	0.53 mm ID x 3.0 µm Film Thickness x 30 m Length BPX-Volatiles GC Capillary Column
054985	0.53 mm ID x 3.0 µm Film Thickness x 60 m Length BPX-Volatiles GC Capillary Column

For more information about this product visit [www.sge.com](http://www.sge.com) or contact [techsupport@sge.com](mailto:techsupport@sge.com).

## Separations | GC Column CYDEX-B™

More than five decades of innovative phase technologies and unique fused silica production capabilities, together provide end-to-end separation solutions for all applications.

### Features and Benefits

Permethylated Beta-Cyclodextrin phase for the separation of chiral compounds.

### Recommended Applications

Separation of enantiomeric compounds found in natural products.

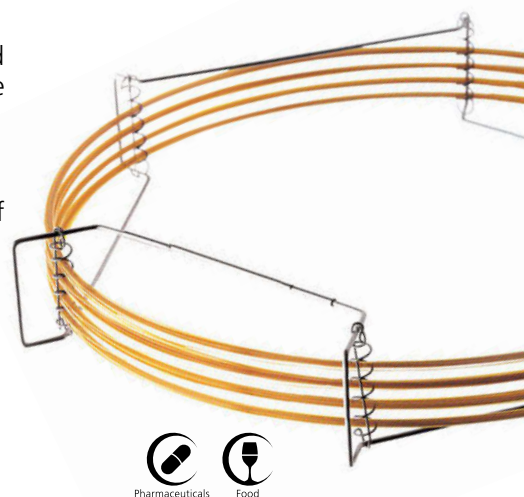

### Product Specifications

Permethylated Beta-Cyclodextrin (Chiral). Suitable replacement for: Cyclodex-B, Rt-BDEXm, LIPODEX C.

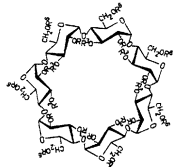

Film Thickness	Operating Temperature
0.25 $\mu\text{m}$	30°C to 220/240 °C

For more information about this product visit [www.sge.com](http://www.sge.com) or contact [techsupport@sge.com](mailto:techsupport@sge.com).

## Separations | GC Column CYDEX-B™

Part Number	Part Description and Detail
054900	0.22 mm ID x 0.25 µm Film Thickness x 25 m Length CYDEX-B GC Capillary Column
054901	0.22 mm ID x 0.25 µm Film Thickness x 50 m Length CYDEX-B GC Capillary Column

For more information about this product visit [www.sge.com](http://www.sge.com) or contact [techsupport@sge.com](mailto:techsupport@sge.com).

## Separations | GC Column HT5

More than five decades of innovative phase technologies and unique fused silica production capabilities, together provide end-to-end separation solutions for all applications.

### Features and Benefits

- Ultra high temperature columns.
- Unique phase – no equivalent phases.
- Ideal for simulated distillation applications (petroleum industry).
- Bonded and cross-linked. Able to be solvent rinsed.

### Recommended Applications

- Simulated distillation.
- General hydrocarbon profiles.
- Pesticides/herbicides.
- GC/MS applications.

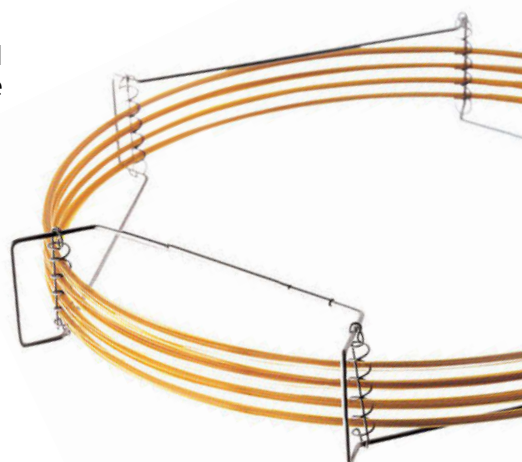

### Product Specifications

5% Phenyl Polycarborane-siloxane. Suitable replacement for: MXT-1 Sim Dist, HT-Sim, DistCB, MXT-500.

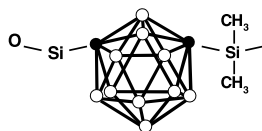

Film Thickness	Operating Temperature
Polyimide Clad 0.1, 0.15, 0.5 $\mu\text{m}$	10 $^{\circ}\text{C}$ to 380/400 $^{\circ}\text{C}$
Aluminum Clad 0.075, 0.1, 0.15 $\mu\text{m}$	10 $^{\circ}\text{C}$ to 460/480 $^{\circ}\text{C}$

For more information about this product visit [www.sge.com](http://www.sge.com) or contact [techsupport@sge.com](mailto:techsupport@sge.com).

## Separations | GC Column HT5

Part Number	Part Description and Detail
054635	0.22 mm ID x 0.1 µm Film Thickness x 12 m Length HT5 GC Capillary Column (Aluminium Clad)
054631	0.22 mm ID x 0.1 µm Film Thickness x 12 m Length HT5 GC Capillary Column
054636	0.22 mm ID x 0.1 µm Film Thickness x 25 m Length HT5 GC Capillary Column (Aluminium Clad)
054632	0.22 mm ID x 0.1 µm Film Thickness x 25 m Length HT5 GC Capillary Column
054633	0.25 mm ID x 0.1 µm Film Thickness x 15 m Length HT5 GC Capillary Column
054634	0.25 mm ID x 0.1 µm Film Thickness x 30 m Length HT5 GC Capillary Column
054651	0.32 mm ID x 0.1 µm Film Thickness x 12 m Length HT5 GC Capillary Column (Aluminium Clad)
054652	0.32 mm ID x 0.1 µm Film Thickness x 25 m Length HT5 GC Capillary Column (Aluminium Clad)
054641	0.32 mm ID x 0.1 µm Film Thickness x 12 m Length HT5 GC Capillary Column
054642	0.32 mm ID x 0.1 µm Film Thickness x 25 m Length HT5 GC Capillary Column
054667	0.32 mm ID x 0.5 µm Film Thickness x 15 m Length HT5 GC Capillary Column
054668	0.32 mm ID x 0.5 µm Film Thickness x 30 m Length HT5 GC Capillary Column
054673	0.53 mm ID x 0.075 µm Film Thickness x 5 m Length HT5 GC Capillary Column (Aluminium Clad)
054661	0.53 mm ID x 0.1 µm Film Thickness x 6 m Length HT5 GC Capillary Column (Aluminium Clad)
054655	0.53 mm ID x 0.1 µm Film Thickness x 6 m Length HT5 GC Capillary Column
054662	0.53 mm ID x 0.15 µm Film Thickness x 12 m Length HT5 GC Capillary Column (Aluminium Clad)
054657	0.53 mm ID x 0.15 µm Film Thickness x 12 m Length HT5 GC Capillary Column
054665	0.53 mm ID x 0.15 µm Film Thickness x 25 m Length HT5 GC Capillary Column (Aluminium Clad)
054658	0.53 mm ID x 0.15 µm Film Thickness x 25 m Length HT5 GC Capillary Column
054670	0.53 mm ID x 0.5 µm Film Thickness x 10 m Length HT5 GC Capillary Column
054672	0.53 mm ID x 0.5 µm Film Thickness x 30 m Length HT5 GC Capillary Column

For more information about this product visit [www.sge.com](http://www.sge.com) or contact [techsupport@sge.com](mailto:techsupport@sge.com).

## Separations | GC Column HT8

More than five decades of innovative phase technologies and unique fused silica production capabilities, together provide end-to-end separation solutions for all applications.

### Features and Benefits

- Preferred column for polychlorinated biphenyl (PCB) compounds.
- Separates PCB's on ortho ring substitution as well as boiling point.

### Recommended Applications

- PCB congener analyses.
- Nitro-substituted aromatics.
- Polynuclear aromatic hydrocarbons.
- Pesticides/herbicides.

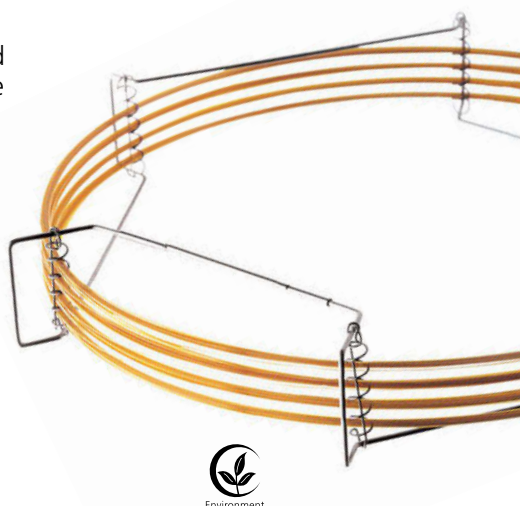

### Product Specifications

8% Phenyl Polycarborane-siloxane. Suitable replacement for: no equivalents, unique ultra high temperature column.

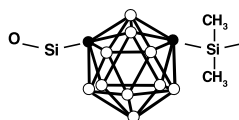

Film Thickness	Operating Temperature
0.25 $\mu\text{m}$	-20 $^{\circ}\text{C}$ to 360/370 $^{\circ}\text{C}$

For more information about this product visit [www.sge.com](http://www.sge.com) or contact [techsupport@sge.com](mailto:techsupport@sge.com).



## Separations | GC Column HT8

Part Number	Part Description and Detail
054675	0.22 mm ID x 0.25 µm Film Thickness x 25 m Length HT8 GC Capillary Column
054676	0.22 mm ID x 0.25 µm Film Thickness x 50 m Length HT8 GC Capillary Column
054677	0.25 mm ID x 0.25 µm Film Thickness x 30 m Length HT8 GC Capillary Column
054683	0.25 mm ID x 0.25 µm Film Thickness x 60 m Length HT8 GC Capillary Column
054680	0.32 mm ID x 0.25 µm Film Thickness x 25 m Length HT8 GC Capillary Column
054682	0.32 mm ID x 0.25 µm Film Thickness x 60 m Length HT8 GC Capillary Column

For more information about this product visit [www.sge.com](http://www.sge.com) or contact [techsupport@sge.com](mailto:techsupport@sge.com).

## Separations | GC Column SolGel-1ms™

More than five decades of innovative phase technologies and unique fused silica production capabilities, together provide end-to-end separation solutions for all applications.

### Features and Benefits

- A robust, inert, high temperature, non-polar phase for use with mass spectrometers.
- Highly inert.
- Less Bleed - Better MS library identification.
- Less bleed - Less ion source maintenance
- Less Bleed - Better sensitivity.
- Can also be used for all non-MS detectors.
- Same selectivity as BP1.

### Recommended Applications

Recommended for highly active compounds.

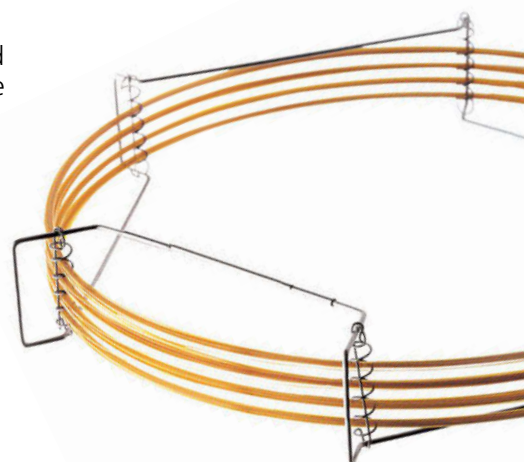

### Product Specifications

100% Dimethyl Polysiloxane in a Sol-Gel matrix. Suitable replacement for: DB-1, DB-Petro, HP-1, HP-1MS, Rtx-1, Ultra-1, SPB-1, SPB-1 Sulfur, Petrocol DH, CP-Sil 5CB, VB-1, ZB-1, VF-1ms.

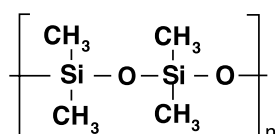

Film Thickness	Operating Temperature
0.25 μm	0 °C to 340/360 °C

For more information about this product visit [www.sge.com](http://www.sge.com) or contact [techsupport@sge.com](mailto:techsupport@sge.com).

## Separations | GC Column SolGel-1ms™

Part Number	Part Description and Detail
054793	0.25 mm ID x 0.25 µm Film Thickness x 60 m Length SolGel-1ms GC Capillary Column
054795	0.25 mm ID x 0.25 µm Film Thickness x 30 m Length SolGel-1ms GC Capillary Column
054798	0.32 mm ID x 0.25 µm Film Thickness x 30 m Length SolGel-1ms GC Capillary Column

For more information about this product visit [www.sge.com](http://www.sge.com) or contact [techsupport@sge.com](mailto:techsupport@sge.com).

## Separations | GC Column SolGel-WAX™

More than five decades of innovative phase technologies and unique fused silica production capabilities, together provide end-to-end separation solutions for all applications.

### Features and Benefits

- Bonded polyethylene glycol.
- Very robust high-temperature column.
- Less susceptible to damage by oxygen than conventional wax phases.
- Polar phase.
- Low bleed and inert.
- Bonded and cross-linked. Able to be solvent rinsed.

### Recommended Applications

Highly active compounds.

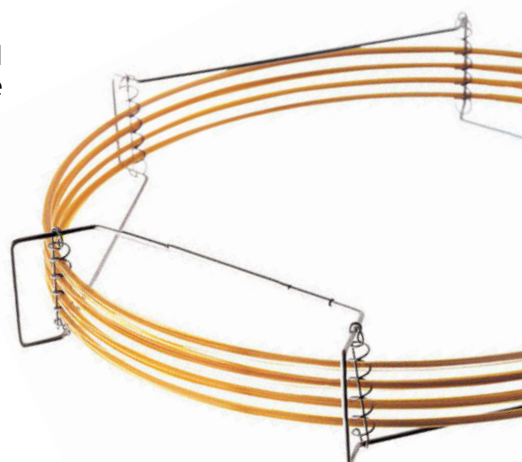

### Product Specifications

Polyethylene Glycol (PEG) in a Sol-Gel matrix. Suitable replacement for: DB-Wax, Rtx-Wax, Stabilwax, HP20M, HP-Wax, HP-INNOWax, Supelcowax-10, AT-Wax, Nukol, CP, Wax 52CB, VB-WAX, ZB-WAX.

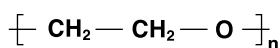

Film Thickness	Operating Temperature
0.1, 0.25, 0.5, 1 $\mu\text{m}$	30 $^{\circ}\text{C}$ to 260/280 $^{\circ}\text{C}$

For more information about this product visit [www.sge.com](http://www.sge.com) or contact [techsupport@sge.com](mailto:techsupport@sge.com).

## Separations | GC Column SolGel-WAX™

Part Number	Part Description and Detail
0547100	0.1 mm ID x 0.1 µm Film Thickness x 10 m Length SolGel-WAX GC Capillary Column
054796	0.25 mm ID x 0.25 µm Film Thickness x 30 m Length SolGel-WAX GC Capillary Column
054791	0.25 mm ID x 0.25 µm Film Thickness x 60 m Length SolGel-WAX GC Capillary Column
054787	0.25 mm ID x 1.0 µm Film Thickness x 30 m Length SolGel-WAX GC Capillary Column
054788	0.32 mm ID x 0.25 µm Film Thickness x 30 m Length SolGel-WAX GC Capillary Column
054789	0.32 mm ID x 0.25 µm Film Thickness x 60 m Length SolGel-WAX GC Capillary Column
054797	0.32 mm ID x 0.5 µm Film Thickness x 30 m Length SolGel-WAX GC Capillary Column
054792	0.32 mm ID x 0.5 µm Film Thickness x 60 m Length SolGel-WAX GC Capillary Column
054786	0.53 mm ID x 0.5 µm Film Thickness x 30 m Length SolGel-WAX GC Capillary Column
054784	0.53 mm ID x 1.0 µm Film Thickness x 15 m Length SolGel-WAX GC Capillary Column
054785	0.53 mm ID x 1.0 µm Film Thickness x 30 m Length SolGel-WAX GC Capillary Column

For more information about this product visit [www.sge.com](http://www.sge.com) or contact [techsupport@sge.com](mailto:techsupport@sge.com).

# Separations | HPLC Capillary Column ProteCol®

Turn Imagination into Results

The ProteCol® capillary HPLC design includes integrated connection tubing with PEEKsil® for the column body and connection capillaries delivering robust design, zero volume connections and uninterrupted flow.

## Features and Benefits

Integrated PEEKsil connection tubing, PEEKsil column body, and zero volume connections allows for use with:

- Small samples.
- Exotic solvents.
- Low concentrations.
- Direct coupling into MS.

## Recommended Applications

- Biotechnology.
- Medical research.
- Proteomics.
- Pharmaceuticals.

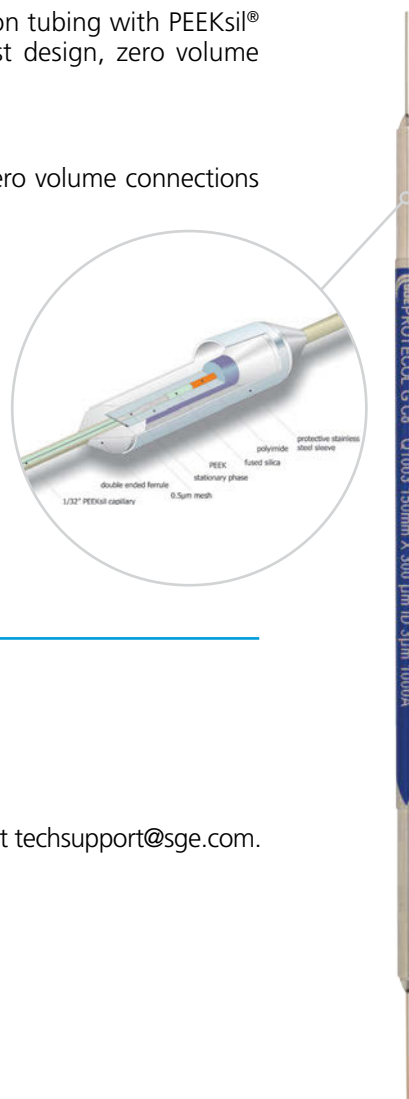

## Product Specifications

150 µm and 300 µm. Available in C18, C8 and C4 phases.

For more information about this product visit [www.sge.com](http://www.sge.com) or contact [techsupport@sge.com](mailto:techsupport@sge.com).









Part Number	Part Description and Detail
2POL-03L30KG	C18P x 3 µm Particle Size x 120 Å Pore Size, 50 mm Length x 300 µm ID, PEEKsil with Guard ProteCol HPLC Capillary Column
2POL-03M30K	C18P x 3 µm Particle Size x 120 Å Pore Size, 100 mm Length x 300 µm ID, PEEKsil ProteCol HPLC Capillary Column
2POL-03M30KG	C18P x 3 µm Particle Size x 120 Å Pore Size, 100 mm Length x 300 µm ID, PEEKsil with Guard ProteCol HPLC Capillary Column
2POL-03N30K	C18P x 3 µm Particle Size x 120 Å Pore Size, 150 mm Length x 300 µm ID, PEEKsil ProteCol HPLC Capillary Column
2POL-03N30KG	C18P x 3 µm Particle Size x 120 Å Pore Size, 150 mm Length x 300 µm ID, PEEKsil with Guard ProteCol HPLC Capillary Column
2POL-05L30K	C18P x 5 µm Particle Size x 120 Å Pore Size, 50 mm Length x 300 µm ID, PEEKsil ProteCol HPLC Capillary Column
2POL-05L30KG	C18P x 5 µm Particle Size x 120 Å Pore Size, 50 mm Length x 300 µm ID, PEEKsil with Guard ProteCol HPLC Capillary Column
2POL-05M30K	C18P x 5 µm Particle Size x 120 Å Pore Size, 100 mm Length x 300 µm ID, PEEKsil ProteCol HPLC Capillary Column
2POL-05M30KG	C18P x 5 µm Particle Size x 120 Å Pore Size, 100 mm Length x 300 µm ID, PEEKsil with Guard ProteCol HPLC Capillary Column
2POL-05N30K	C18P x 5 µm Particle Size x 120 Å Pore Size, 150 mm Length x 300 µm ID, PEEKsil ProteCol HPLC Capillary Column
2POL-05N30KG	C18P x 5 µm Particle Size x 120 Å Pore Size, 150 mm Length x 300 µm ID, PEEKsil with Guard ProteCol HPLC Capillary Column
<b>C18Q</b>	
<b>100 Å Pore Size</b>	
2C183-03L15K	C18Q x 3 µm Particle Size x 100 Å Pore Size, 50 mm Length x 150 µm ID, PEEKsil ProteCol HPLC Capillary Column
2C183-03L15KG	C18Q x 3 µm Particle Size x 100 Å Pore Size, 50 mm Length x 150 µm ID, PEEKsil with Guard ProteCol HPLC Capillary Column
2C183-03L30K	C18Q x 3 µm Particle Size x 100 Å Pore Size, 50 mm Length x 300 µm ID, PEEKsil ProteCol HPLC Capillary Column
2C183-03L30KG	C18Q x 3 µm Particle Size x 100 Å Pore Size, 50 mm Length x 300 µm ID, PEEKsil with Guard ProteCol HPLC Capillary Column
2C183-03M15K	C18Q x 3 µm Particle Size x 100 Å Pore Size, 100 mm Length x 150 µm ID, PEEKsil ProteCol HPLC Capillary Column
2C183-03M15KG	C18Q x 3 µm Particle Size x 100 Å Pore Size, 100 mm Length x 150 µm ID, PEEKsil with Guard ProteCol HPLC Capillary Column
2C183-03M30K	C18Q x 3 µm Particle Size x 100 Å Pore Size, 100 mm Length x 300 µm ID, PEEKsil ProteCol HPLC Capillary Column
2C183-03M30KG	C18Q x 3 µm Particle Size x 100 Å Pore Size, 100 mm Length x 300 µm ID, PEEKsil with Guard ProteCol HPLC Capillary Column
2C183-03N15K	C18Q x 3 µm Particle Size x 100 Å Pore Size, 150 mm Length x 150 µm ID, PEEKsil ProteCol HPLC Capillary Column
2C183-03N15KG	C18Q x 3 µm Particle Size x 100 Å Pore Size, 150 mm Length x 150 µm ID, PEEKsil with Guard ProteCol HPLC Capillary Column
2C183-03N30K	C18Q x 3 µm Particle Size x 100 Å Pore Size, 150 mm Length x 300 µm ID, PEEKsil ProteCol HPLC Capillary Column
2C183-03N30KG	C18Q x 3 µm Particle Size x 100 Å Pore Size, 150 mm Length x 300 µm ID, PEEKsil with Guard ProteCol HPLC Capillary Column
2C183-05L15K	C18Q x 5 µm Particle Size x 100 Å Pore Size, 50 mm Length x 150 µm ID, PEEKsil ProteCol HPLC Capillary Column
2C183-05L15KG	C18Q x 5 µm Particle Size x 100 Å Pore Size, 50 mm Length x 150 µm ID, PEEKsil with Guard ProteCol HPLC Capillary Column
2C183-05L30K	C18Q x 5 µm Particle Size x 100 Å Pore Size, 50 mm Length x 300 µm ID, PEEKsil ProteCol HPLC Capillary Column
2C183-05L30KG	C18Q x 5 µm Particle Size x 100 Å Pore Size, 50 mm Length x 300 µm ID, PEEKsil with Guard ProteCol HPLC Capillary Column
2C183-05M15K	C18Q x 5 µm Particle Size x 100 Å Pore Size, 100 mm Length x 150 µm ID, PEEKsil ProteCol HPLC Capillary Column
2C183-05M15KG	C18Q x 5 µm Particle Size x 100 Å Pore Size, 100 mm Length x 150 µm ID, PEEKsil with Guard ProteCol HPLC Capillary Column
2C183-05M30K	C18Q x 5 µm Particle Size x 100 Å Pore Size, 100 mm Length x 300 µm ID, PEEKsil ProteCol HPLC Capillary Column
2C183-05M30KG	C18Q x 5 µm Particle Size x 100 Å Pore Size, 100 mm Length x 300 µm ID, PEEKsil with Guard ProteCol HPLC Capillary Column
2C183-05N15K	C18Q x 5 µm Particle Size x 100 Å Pore Size, 150 mm Length x 150 µm ID, PEEKsil ProteCol HPLC Capillary Column
2C183-05N15KG	C18Q x 5 µm Particle Size x 100 Å Pore Size, 150 mm Length x 150 µm ID, PEEKsil with Guard ProteCol HPLC Capillary Column
2C183-05N30K	C18Q x 5 µm Particle Size x 100 Å Pore Size, 150 mm Length x 300 µm ID, PEEKsil ProteCol HPLC Capillary Column
2C183-05N30KG	C18Q x 5 µm Particle Size x 100 Å Pore Size, 150 mm Length x 300 µm ID, PEEKsil with Guard ProteCol HPLC Capillary Column

For more information visit [www.sge.com](http://www.sge.com) or contact [techsupport@sge.com](mailto:techsupport@sge.com).



## Separations | HPLC Column ProteCol® C18

Turn Imagination into Results

High quality phases and a variety of hardware options provide a perfect match for all your separation needs.

### Features and Benefits

- A range of C18 phases including options for pore size and pH stability.
- Reduced sample and column preparation time.
- Improved peak shape, reproducibility and sensitivity.
- Reduced carry over.

### Recommended Applications

General purpose reverse phase separations.

### Product Specifications

0.15, 0.3, 1, 2.1, 3, and 4.6 mm ID columns available in 50, 100, 150, 250 mm lengths.

PEEK coated, and PEEKsil®, column hardware available to reduce non-specific interactions when analyzing compounds with metal chelating activity.

Phase	Specifications	Pore Size (Å)	Particle Size (µm)	Pore Volume (ml)	Surface Area	Carbon Load %	USP Code
C18 Q	<ul style="list-style-type: none"> <li>• Ultra pure silica</li> <li>• Fully end capped optimized C18 phases</li> </ul>	100	3, 5	1.0 ± 0.1	400 ± 40	16.8	L1
C18 G	<ul style="list-style-type: none"> <li>• Stable in aqueous conditions</li> <li>• Reduces non-specific analyte interactions</li> <li>• Separates polar compounds</li> <li>• pH stability 1 - 9</li> </ul>	120	2.5, 3, 5, 10	1.0 ± 0.1	300 ± 40	17.1	L1
		200	3, 5	1.0 ± 0.1	200 ± 30	12.6	L1
		300	3, 5	1.0 ± 0.1	100 ± 20	6.9	L1
C18 H	<ul style="list-style-type: none"> <li>• Modified bonded phase making it easier to work from low to high pH using the same column</li> <li>• Novel chemical bonding ensuring stability under extreme alkaline and acidic conditions</li> <li>• pH stability 1 -11</li> </ul>	120	5	1.0 ± 0.1	300 ± 40	20.9	L1
C18 P	<ul style="list-style-type: none"> <li>• Polar embedded C18</li> <li>• 100 % compatible with water</li> <li>• pH stability 1 - 9</li> </ul>	120	3, 5	1.0 ± 0.1	300 ± 40	14.5	L1



For more information about this product visit [www.sge.com](http://www.sge.com) or contact [techsupport@sge.com](mailto:techsupport@sge.com).





















# Separations | HPLC Column ProteCol® C4

## Turn Imagination into Results

High quality phases and a variety of hardware options provide a perfect match for all your separation needs.

### Features and Benefits

High durability and extended acidic and alkaline resistance.

### Recommended Applications

Recommended for compounds too strongly retained on C18 and C8 phases, and protein purification.

### Product Specifications

0.15, 0.3, 1, 2.1, 3, and 4.6 mm ID columns available in 50, 100, 150, 250 mm lengths.

PEEK coated, and PEEKsil®, column hardware available to reduce non-specific interactions when analyzing compounds with metal chelating activity.

Phase	Pore Size (Å)	Particle Size (µm)	Particle Volume	Surface Area	% Carbon Load	pH	USP Code
C4	300	5	0.9	100	3	1-11	L26

For more information about this product visit [www.sge.com](http://www.sge.com) or contact [techsupport@sge.com](mailto:techsupport@sge.com).





Part Number	Part Description and Detail
2C42-05R02P	C4G x 5 µm Particle Size x 300 Å Pore Size, 250 mm Length x 2.1 mm ID, PEEK Coated ProteCol HPLC Column
2C42-05R02PG	C4G x 5 µm Particle Size x 300 Å Pore Size, 250 mm Length x 2.1 mm ID, PEEK Coated with Guard ProteCol HPLC Column
2C42-05L03P	C4G x 5 µm Particle Size x 300 Å Pore Size, 50 mm Length x 3.0 mm ID, PEEK Coated ProteCol HPLC Column
2C42-05L03PG	C4G x 5 µm Particle Size x 300 Å Pore Size, 50 mm Length x 3.0 mm ID, PEEK Coated with Guard ProteCol HPLC Column
2C42-05M03P	C4G x 5 µm Particle Size x 300 Å Pore Size, 100 mm Length x 3.0 mm ID, PEEK Coated ProteCol HPLC Column
2C42-05M03PG	C4G x 5 µm Particle Size x 300 Å Pore Size, 100 mm Length x 3.0 mm ID, PEEK Coated with Guard ProteCol HPLC Column
2C42-05N03P	C4G x 5 µm Particle Size x 300 Å Pore Size, 150 mm Length x 3.0 mm ID, PEEK Coated ProteCol HPLC Column
2C42-05N03PG	C4G x 5 µm Particle Size x 300 Å Pore Size, 150 mm Length x 3.0 mm ID, PEEK Coated with Guard ProteCol HPLC Column
2C42-05R03P	C4G x 5 µm Particle Size x 300 Å Pore Size, 250 mm Length x 3.0 mm ID, PEEK Coated ProteCol HPLC Column
2C42-05R03PG	C4G x 5 µm Particle Size x 300 Å Pore Size, 250 mm Length x 3.0 mm ID, PEEK Coated with Guard ProteCol HPLC Column
2C42-05L46P	C4G x 5 µm Particle Size x 300 Å Pore Size, 50 mm Length x 4.6 mm ID, PEEK Coated ProteCol HPLC Column
2C42-05L46PG	C4G x 5 µm Particle Size x 300 Å Pore Size, 50 mm Length x 4.6 mm ID, PEEK Coated with Guard ProteCol HPLC Column
2C42-05M46P	C4G x 5 µm Particle Size x 300 Å Pore Size, 100 mm Length x 4.6 mm ID, PEEK Coated ProteCol HPLC Column
2C42-05M46PG	C4G x 5 µm Particle Size x 300 Å Pore Size, 100 mm Length x 4.6 mm ID, PEEK Coated with Guard ProteCol HPLC Column
2C42-05N46P	C4G x 5 µm Particle Size x 300 Å Pore Size, 150 mm Length x 4.6 mm ID, PEEK Coated ProteCol HPLC Column
2C42-05N46PG	C4G x 5 µm Particle Size x 300 Å Pore Size, 150 mm Length x 4.6 mm ID, PEEK Coated with Guard ProteCol HPLC Column
2C42-05R46P	C4G x 5 µm Particle Size x 300 Å Pore Size, 250 mm Length x 4.6 mm ID, PEEK Coated ProteCol HPLC Column
2C42-05R46PG	C4G x 5 µm Particle Size x 300 Å Pore Size, 250 mm Length x 4.6 mm ID, PEEK Coated with Guard ProteCol HPLC Column
<b>PEEKsil</b>	
2C42-05G15K	C4G x 5 µm Particle Size x 300 Å Pore Size, 10 mm Length x 150 µm ID, PEEKsil ProteCol HPLC Guard Column PK3
2C42-05G30K	C4G x 5 µm Particle Size x 300 Å Pore Size, 10 mm Length x 300 µm ID, PEEKsil ProteCol HPLC Guard Column PK3
2C42-05T15K	C4G x 5 µm Particle Size x 300 Å Pore Size, 10 mm Length x 150 µm ID, PEEKsil ProteCol HPLC Trap Column
2C42-05T30K	C4G x 5 µm Particle Size x 300 Å Pore Size, 10 mm Length x 300 µm ID, PEEKsil ProteCol HPLC Trap Column

For more information visit [www.sge.com](http://www.sge.com) or contact [techsupport@sge.com](mailto:techsupport@sge.com).



## Separations | HPLC Column ProteCol® C8

Turn Imagination into Results

High quality phases and a variety of hardware options provide a perfect match for all your separation needs.

### Features and Benefits

- Pore sizes to suit your analysis (1000 Å or 120 Å).
- Intermediate polarity C8 phase.
- Continuity of using HPLC for all separation needs simplifies your workflow.
- Facilitates the use of MS.
- Eliminate SDS-PAGE from your workflow.

### Recommended Applications

120 Å recommended for compounds too strongly retained on C18 phases, 1000 Å recommended for proteins.

### Product Specifications

0.15, 0.3, 1, 2.1, 3, and 4.6 mm ID columns available in 50, 100, 150, 250 mm lengths.

PEEK coated, and PEEKsil®, column hardware available to reduce non-specific interactions when analyzing compounds with metal chelating activity.

Phase	Pore Size (Å)	Particle Size (µm)	Pore Volume (ml)	Surface Area	Carbon Load %	USP Code
C8	120	5	1.0 ± 0.1	300 ± 40	11.7	L7
C8	1000	3	0.8 ± 0.1	25 ± 5	0.7	L7

For more information about this product visit [www.sge.com](http://www.sge.com) or contact [techsupport@sge.com](mailto:techsupport@sge.com).











# Separations | HPLC Column ProteCol® Phenyl Hexyl

Turn Imagination into Results

High quality phases and a variety of hardware options provide a perfect match for all your separation needs.

## Features and Benefits

ProteCol® Phenyl-Hexyl uses a hexyl-linked phenyl phase where the hexyl alkyl chain delivers unique selectivity and increased hydrolytic stability when compared to propyl-linked chemistry.

## Recommended Applications

Recommended for compounds that are difficult to separate on standard phenyl phase columns.

## Product Specifications

2.1, 3, and 4.6 mm ID columns available in 50, 100, 150, 250 mm lengths.

Phase	Pore Size (Å)	Particle Size (µm)	Surface Area	% Carbon Load	pH	USP Code
Phenyl Hexyl	120	3, 5	350	10.0	1-10	L11

For more information about this product visit [www.sge.com](http://www.sge.com) or contact [techsupport@sge.com](mailto:techsupport@sge.com).





Part Number	Part Description and Detail
2NH4-05M02P	Phenyl Hexyl x 5 µm Particle Size x 120 Å Pore Size, 100 mm Length x 2.1 mm ID, PEEK Coated ProteCol HPLC Column
2NH4-05M02PG	Phenyl Hexyl x 5 µm Particle Size x 120 Å Pore Size, 100 mm Length x 2.1 mm ID, PEEK Coated with Guard ProteCol HPLC Column
2NH4-05N02P	Phenyl Hexyl x 5 µm Particle Size x 120 Å Pore Size, 150 mm Length x 2.1 mm ID, PEEK Coated ProteCol HPLC Column
2NH4-05N02PG	Phenyl Hexyl x 5 µm Particle Size x 120 Å Pore Size, 150 mm Length x 2.1 mm ID, PEEK Coated with Guard ProteCol HPLC Column
2NH4-05R02P	Phenyl Hexyl x 5 µm Particle Size x 120 Å Pore Size, 250 mm Length x 2.1 mm ID, PEEK Coated ProteCol HPLC Column
2NH4-05R02PG	Phenyl Hexyl x 5 µm Particle Size x 120 Å Pore Size, 250 mm Length x 2.1 mm ID, PEEK Coated with Guard ProteCol HPLC Column
2NH4-03L03P	Phenyl Hexyl x 3 µm Particle Size x 120 Å Pore Size, 50 mm Length x 3.0 mm ID, PEEK Coated ProteCol HPLC Column
2NH4-03L03PG	Phenyl Hexyl x 3 µm Particle Size x 120 Å Pore Size, 50 mm Length x 3.0 mm ID, PEEK Coated with Guard ProteCol HPLC Column
2NH4-03M03P	Phenyl Hexyl x 3 µm Particle Size x 120 Å Pore Size, 100 mm Length x 3.0 mm ID, PEEK Coated ProteCol HPLC Column
2NH4-03M03PG	Phenyl Hexyl x 3 µm Particle Size x 120 Å Pore Size, 100 mm Length x 3.0 mm ID, PEEK Coated with Guard ProteCol HPLC Column
2NH4-03N03P	Phenyl Hexyl x 3 µm Particle Size x 120 Å Pore Size, 150 mm Length x 3.0 mm ID, PEEK Coated ProteCol HPLC Column
2NH4-03N03PG	Phenyl Hexyl x 3 µm Particle Size x 120 Å Pore Size, 150 mm Length x 3.0 mm ID, PEEK Coated with Guard ProteCol HPLC Column
2NH4-05L03P	Phenyl Hexyl x 5 µm Particle Size x 120 Å Pore Size, 50 mm Length x 3.0 mm ID, PEEK Coated ProteCol HPLC Column
2NH4-05L03PG	Phenyl Hexyl x 5 µm Particle Size x 120 Å Pore Size, 50 mm Length x 3.0 mm ID, PEEK Coated with Guard ProteCol HPLC Column
2NH4-05M03P	Phenyl Hexyl x 5 µm Particle Size x 120 Å Pore Size, 100 mm Length x 3.0 mm ID, PEEK Coated ProteCol HPLC Column
2NH4-05M03PG	Phenyl Hexyl x 5 µm Particle Size x 120 Å Pore Size, 100 mm Length x 3.0 mm ID, PEEK Coated with Guard ProteCol HPLC Column
2NH4-05N03P	Phenyl Hexyl x 5 µm Particle Size x 120 Å Pore Size, 150 mm Length x 3.0 mm ID, PEEK Coated ProteCol HPLC Column
2NH4-05N03PG	Phenyl Hexyl x 5 µm Particle Size x 120 Å Pore Size, 150 mm Length x 3.0 mm ID, PEEK Coated with Guard ProteCol HPLC Column
2NH4-05R03P	Phenyl Hexyl x 5 µm Particle Size x 120 Å Pore Size, 250 mm Length x 3.0 mm ID, PEEK Coated ProteCol HPLC Column
2NH4-05R03PG	Phenyl Hexyl x 5 µm Particle Size x 120 Å Pore Size, 250 mm Length x 3.0 mm ID, PEEK Coated with Guard ProteCol HPLC Column
2NH4-03L46P	Phenyl Hexyl x 3 µm Particle Size x 120 Å Pore Size, 50 mm Length x 4.6 mm ID, PEEK Coated ProteCol HPLC Column
2NH4-03L46PG	Phenyl Hexyl x 3 µm Particle Size x 120 Å Pore Size, 50 mm Length x 4.6 mm ID, PEEK Coated with Guard ProteCol HPLC Column
2NH4-03M46P	Phenyl Hexyl x 3 µm Particle Size x 120 Å Pore Size, 100 mm Length x 4.6 mm ID, PEEK Coated ProteCol HPLC Column
2NH4-03M46PG	Phenyl Hexyl x 3 µm Particle Size x 120 Å Pore Size, 100 mm Length x 4.6 mm ID, PEEK Coated with Guard ProteCol HPLC Column
2NH4-03N46P	Phenyl Hexyl x 3 µm Particle Size x 120 Å Pore Size, 150 mm Length x 4.6 mm ID, PEEK Coated ProteCol HPLC Column
2NH4-03N46PG	Phenyl Hexyl x 3 µm Particle Size x 120 Å Pore Size, 150 mm Length x 4.6 mm ID, PEEK Coated with Guard ProteCol HPLC Column
2NH4-05L46P	Phenyl Hexyl x 5 µm Particle Size x 120 Å Pore Size, 50 mm Length x 4.6 mm ID, PEEK Coated ProteCol HPLC Column
2NH4-05L46PG	Phenyl Hexyl x 5 µm Particle Size x 120 Å Pore Size, 50 mm Length x 4.6 mm ID, PEEK Coated with Guard ProteCol HPLC Column
2NH4-05M46P	Phenyl Hexyl x 5 µm Particle Size x 120 Å Pore Size, 100 mm Length x 4.6 mm ID, PEEK Coated ProteCol HPLC Column
2NH4-05M46PG	Phenyl Hexyl x 5 µm Particle Size x 120 Å Pore Size, 100 mm Length x 4.6 mm ID, PEEK Coated with Guard ProteCol HPLC Column
2NH4-05N46P	Phenyl Hexyl x 5 µm Particle Size x 120 Å Pore Size, 150 mm Length x 4.6 mm ID, PEEK Coated ProteCol HPLC Column
2NH4-05N46PG	Phenyl Hexyl x 5 µm Particle Size x 120 Å Pore Size, 150 mm Length x 4.6 mm ID, PEEK Coated with Guard ProteCol HPLC Column
2NH4-05R46P	Phenyl Hexyl x 5 µm Particle Size x 120 Å Pore Size, 250 mm Length x 4.6 mm ID, PEEK Coated ProteCol HPLC Column
2NH4-05R46PG	Phenyl Hexyl x 5 µm Particle Size x 120 Å Pore Size, 250 mm Length x 4.6 mm ID, PEEK Coated with Guard ProteCol HPLC Column

For more information visit [www.sge.com](http://www.sge.com) or contact [techsupport@sge.com](mailto:techsupport@sge.com).



# Separations | HPLC Column ProteCol® Chiral

## Turn Imagination into Results

High quality phases and a variety of hardware options provide a perfect match for all your separation needs.

### Features and Benefits

ProteCol® Chiral columns ensure the isolation and analysis of pure enantiomers.

### Recommended Applications

Enantiomers.

### Product Specifications

ProteCol Chiral CHM is a modified cellulose coated on the high purity, high performance spherical silica particles. The chemical modification includes the chemical bonding of 3-chloro-4 methylphenylcarbamate to cellulose. The use of cellulose modified with chlorinated phenyl groups moiety provides for the separation for many previously unresolved/poorly resolved chiral mixtures.

ProteCol Chiral CHC are polysaccharide coated chiral columns manufactured using a unique production process of coating the proven chiral selector-tris-(3, 5-dimethylphenyl) carbamoyl cellulose on high purity silica gel.

ProteCol Chiral CHA are polysaccharide coated chiral columns manufactured using a unique production process of coating the proven chiral selector-tris-(3, 5-dimethylphenyl) carbamoyl amylose on high purity silica gel.

ProteCol Chiral CH4 is a modified cellulose coated on the high purity, high performance spherical silica particles. The chemical modification includes the chemical bonding of 4-chloro-3 methylphenylcarbamate to cellulose. The use of cellulose modified with chlorinated phenyl groups moiety provides for the separation for many previously unresolved/poorly resolved chiral mixtures.

Available in 5 and 10 µm particle sizes, in 4,6 mm ID 250 mm long column hardware.

PEEK coated column hardware available to reduce non-specific interactions when analyzing compounds with metal chelating activity.

Phase	Sub Phase	Chemical Structure	Particle Size (µm)
Chiral	CHC	3, 5-dimethylphenylcarbamate cellulose	5, 10
Chiral	CHA	3, 5-dimethylphenylcarbamate amylose	5, 10
Chiral	CHM	3-chloro-4-methylphenylcarbamate cellulose	5, 10
Chiral	CH5	5-chloro-2-methylphenylcarbamate amylose	5, 10
Chiral	CH4	4-chloro-3-methylphenylcarbamate cellulose	5, 10



For more information about this product visit [www.sge.com](http://www.sge.com) or contact [techsupport@sge.com](mailto:techsupport@sge.com).

## Separations | HPLC Column ProteCol® Chiral

Turn Imagination into Results

Part Number	Part Description and Detail
<b>Chiral CHA - 1000Å</b>	
2CHA-05R46S	Chiral CHA x 5 µm Particle Size x 1000 Å Pore Size, 250 mm Length x 4.6 mm ID, Stainless Steel ProteCol HPLC Column
2CHA-10R46S	Chiral CHA x 10 µm Particle Size x 1000 Å Pore Size, 250 mm Length x 4.6 mm ID, Stainless Steel ProteCol HPLC Column
<b>Chiral CHC - 1000Å</b>	
2CHC-05R46S	Chiral CHC x 5 µm Particle Size x 1000 Å Pore Size, 250 mm Length x 4.6 mm ID, Stainless Steel ProteCol HPLC Column
2CHC-10R46S	Chiral CHC x 10 µm Particle Size x 1000 Å Pore Size, 250 mm Length x 4.6 mm ID, Stainless Steel ProteCol HPLC Column
<b>Chiral CHM - 1000Å</b>	
2CHM-05R46S	Chiral CHM x 5 µm Particle Size x 1000 Å Pore Size, 250 mm Length x 4.6 mm ID, Stainless Steel ProteCol HPLC Column
2CHM-10R46S	Chiral CHM x 10 µm Particle Size x 1000 Å Pore Size, 250 mm Length x 4.6 mm ID, Stainless Steel ProteCol HPLC Column
<b>Chiral CH5 - 1000Å</b>	
2CH5-05R46S	Chiral CH5 x 5 µm Particle Size x 1000 Å Pore Size, 250 mm Length x 4.6 mm ID, Stainless Steel ProteCol HPLC Column
2CH5-10R46S	Chiral CH5 x 10 µm Particle Size x 1000 Å Pore Size, 250 mm Length x 4.6 mm ID, Stainless Steel ProteCol HPLC Column
<b>Chiral CH4 - 1000Å</b>	
2CH4-05R46S	Chiral CH4 x 5 µm Particle Size x 1000 Å Pore Size, 250 mm Length x 4.6 mm ID, Stainless Steel ProteCol HPLC Column
2CH4-10R46S	Chiral CH4 x 10 µm Particle Size x 1000 Å Pore Size, 250 mm Length x 4.6 mm ID, Stainless Steel ProteCol HPLC Column

For more information about this product visit [www.sge.com](http://www.sge.com) or contact [techsupport@sge.com](mailto:techsupport@sge.com).



## Separations | HPLC Column ProteCol® HILIC

### Turn Imagination into Results

High quality phases and a variety of hardware options provide a perfect match for all your separation needs.

#### Features and Benefits

Range of polar stationary phases enabling the retention and separation of polar analytes using organic mobile phases.

#### Recommended Applications

Polar analyte analysis.

---

#### Product Specifications

ProteCol® HILIC-RP is a combination of a polyhydroxylated polymer coated and bound to silica and ODS groups also bound to silica. This composition provides hydroxyl levels that are well above conventional hydroxyl and diol type stationary phases. HILIC-RP is an excellent choice for samples containing polar and hydrophobic analytes. Available in 3 and 5  $\mu\text{m}$  particles sizes.

ProteCol HILIC-HC (high capacity) is composed of a polyhydroxylated polymer coated and bound to silica. This composition provides hydroxyl levels that are well above conventional hydroxyl and diol type stationary phases. Available in 5  $\mu\text{m}$  particles sizes.

ProteCol HILIC-FL consists of a fluorinated based stationary phase bound to silica. This composition provides for excellent retention/peak shape for polar halogenated, polar amines and polar aromatic compounds. HILIC-FL is an excellent choice for samples containing polar halogenated, polar amines and polar aromatic compounds where superior retention and peak shape are essential. Available in 5  $\mu\text{m}$  particles sizes.

ProteCol HILIC-PI consists of an aromatic amine based stationary phase bound to silica. This composition provides for excellent retention and peak shape for polar amine compounds. HILIC-PI is an excellent choice for samples containing polar amines where superior retention and peak shape are essential. Available in 5  $\mu\text{m}$  particles sizes.

2.1, 3, and 4.6 mm ID columns available in 50, 100, 150, 250 mm lengths. pH stability 1.5 - 10. Maximum temperature 60 °C

PEEK coated column hardware available to reduce non-specific interactions when analyzing compounds with metal chelating activity.

For more information about this product visit [www.sge.com](http://www.sge.com) or contact [techsupport@sge.com](mailto:techsupport@sge.com).











## Separations | HPLC Column ProteCol® PFP

Turn Imagination into Results

High quality phases and a variety of hardware options provide a perfect match for all your separation needs.

### Features and Benefits

PFP is a truly unique phase with properties significantly different from ODS phases. This unique character results from bonded pentafluorophenyl groups imparting pi-pi electron interaction, producing an enhanced retention for many compounds, particularly those that contain polarizable electrons.

### Recommended Applications

Epimers and other mixtures containing polarizable electrons.

### Product Specifications

2.1, 3, and 4.6 mm ID columns available in 50, 100, 150, 250 mm lengths.

PEEK coated column hardware available to reduce non-specific interactions when analyzing compounds with metal chelating activity.

Phase	Pore Size (Å)	Particle Size (µm)	Surface Area	% Carbon Load	pH	USP Code
PFP	120	3, 5	350	10.0	1-10	L43

For more information about this product visit [www.sge.com](http://www.sge.com) or contact [techsupport@sge.com](mailto:techsupport@sge.com).





Part Number	Part Description and Detail
2PFP-03M03P	PFP x 3 µm Particle Size x 120 Å Pore Size, 100 mm Length x 3.0 mm ID, PEEK Coated ProteCol HPLC Column
2PFP-03M03PG	PFP x 3 µm Particle Size x 120 Å Pore Size, 100 mm Length x 3.0 mm ID, PEEK Coated with Guard ProteCol HPLC Column
2PFP-03M46P	PFP x 3 µm Particle Size x 120 Å Pore Size, 100 mm Length x 4.6 mm ID, PEEK Coated ProteCol HPLC Column
2PFP-03M46PG	PFP x 3 µm Particle Size x 120 Å Pore Size, 100 mm Length x 4.6 mm ID, PEEK Coated with Guard ProteCol HPLC Column
2PFP-03N02P	PFP x 3 µm Particle Size x 120 Å Pore Size, 150 mm Length x 2.1 mm ID, PEEK Coated ProteCol HPLC Column
2PFP-03N02PG	PFP x 3 µm Particle Size x 120 Å Pore Size, 150 mm Length x 2.1 mm ID, PEEK Coated with Guard ProteCol HPLC Column
2PFP-03N03P	PFP x 3 µm Particle Size x 120 Å Pore Size, 150 mm Length x 3.0 mm ID, PEEK Coated ProteCol HPLC Column
2PFP-03N03PG	PFP x 3 µm Particle Size x 120 Å Pore Size, 150 mm Length x 3.0 mm ID, PEEK Coated with Guard ProteCol HPLC Column
2PFP-03N46P	PFP x 3 µm Particle Size x 120 Å Pore Size, 150 mm Length x 4.6 mm ID, PEEK Coated ProteCol HPLC Column
2PFP-03N46PG	PFP x 3 µm Particle Size x 120 Å Pore Size, 150 mm Length x 4.6 mm ID, PEEK Coated with Guard ProteCol HPLC Column
2PFP-05L02P	PFP x 5 µm Particle Size x 120 Å Pore Size, 50 mm Length x 2.1 mm ID, PEEK Coated ProteCol HPLC Column
2PFP-05L02PG	PFP x 5 µm Particle Size x 120 Å Pore Size, 50 mm Length x 2.1 mm ID, PEEK Coated with Guard ProteCol HPLC Column
2PFP-05L03P	PFP x 5 µm Particle Size x 120 Å Pore Size, 50 mm Length x 3.0 mm ID, PEEK Coated ProteCol HPLC Column
2PFP-05L03PG	PFP x 5 µm Particle Size x 120 Å Pore Size, 50 mm Length x 3.0 mm ID, PEEK Coated with Guard ProteCol HPLC Column
2PFP-05L46P	PFP x 5 µm Particle Size x 120 Å Pore Size, 50 mm Length x 4.6 mm ID, PEEK Coated ProteCol HPLC Column
2PFP-05L46PG	PFP x 5 µm Particle Size x 120 Å Pore Size, 50 mm Length x 4.6 mm ID, PEEK Coated with Guard ProteCol HPLC Column
2PFP-05M02P	PFP x 5 µm Particle Size x 120 Å Pore Size, 100 mm Length x 2.1 mm ID, PEEK Coated ProteCol HPLC Column
2PFP-05M02PG	PFP x 5 µm Particle Size x 120 Å Pore Size, 100 mm Length x 2.1 mm ID, PEEK Coated with Guard ProteCol HPLC Column
2PFP-05M03P	PFP x 5 µm Particle Size x 120 Å Pore Size, 100 mm Length x 3.0 mm ID, PEEK Coated ProteCol HPLC Column
2PFP-05M03PG	PFP x 5 µm Particle Size x 120 Å Pore Size, 100 mm Length x 3.0 mm ID, PEEK Coated with Guard ProteCol HPLC Column
2PFP-05M46P	PFP x 5 µm Particle Size x 120 Å Pore Size, 100 mm Length x 4.6 mm ID, PEEK Coated ProteCol HPLC Column
2PFP-05M46PG	PFP x 5 µm Particle Size x 120 Å Pore Size, 100 mm Length x 4.6 mm ID, PEEK Coated with Guard ProteCol HPLC Column
2PFP-05N02P	PFP x 5 µm Particle Size x 120 Å Pore Size, 150 mm Length x 2.1 mm ID, PEEK Coated ProteCol HPLC Column
2PFP-05N02PG	PFP x 5 µm Particle Size x 120 Å Pore Size, 150 mm Length x 2.1 mm ID, PEEK Coated with Guard ProteCol HPLC Column
2PFP-05N03P	PFP x 5 µm Particle Size x 120 Å Pore Size, 150 mm Length x 3.0 mm ID, PEEK Coated ProteCol HPLC Column
2PFP-05N03PG	PFP x 5 µm Particle Size x 120 Å Pore Size, 150 mm Length x 3.0 mm ID, PEEK Coated with Guard ProteCol HPLC Column
2PFP-05N46P	PFP x 5 µm Particle Size x 120 Å Pore Size, 150 mm Length x 4.6 mm ID, PEEK Coated ProteCol HPLC Column
2PFP-05N46PG	PFP x 5 µm Particle Size x 120 Å Pore Size, 150 mm Length x 4.6 mm ID, PEEK Coated with Guard ProteCol HPLC Column
2PFP-05R02P	PFP x 5 µm Particle Size x 120 Å Pore Size, 250 mm Length x 2.1 mm ID, PEEK Coated ProteCol HPLC Column
2PFP-05R02PG	PFP x 5 µm Particle Size x 120 Å Pore Size, 250 mm Length x 2.1 mm ID, PEEK Coated with Guard ProteCol HPLC Column
2PFP-05R03P	PFP x 5 µm Particle Size x 120 Å Pore Size, 250 mm Length x 3.0 mm ID, PEEK Coated ProteCol HPLC Column
2PFP-05R03PG	PFP x 5 µm Particle Size x 120 Å Pore Size, 250 mm Length x 3.0 mm ID, PEEK Coated with Guard ProteCol HPLC Column
2PFP-05R46P	PFP x 5 µm Particle Size x 120 Å Pore Size, 250 mm Length x 4.6 mm ID, PEEK Coated ProteCol HPLC Column
2PFP-05R46PG	PFP x 5 µm Particle Size x 120 Å Pore Size, 250 mm Length x 4.6 mm ID, PEEK Coated with Guard ProteCol HPLC Column

For more information visit [www.sge.com](http://www.sge.com) or contact [techsupport@sge.com](mailto:techsupport@sge.com).





# Separations | HPLC Column ProteCol® SCX

## Turn Imagination into Results

High quality phases and a variety of hardware options provide a perfect match for all your separation needs.

### Features and Benefits

- High loading capacity and pressure limit.
- Robust bonding technology.
- High density bonding.
- Bonding aromatic sulfonic acid groups.

### Recommended Applications

Small organic bases.

### Product Specifications

2.1, 3, and 4.6 mm ID columns available in 50, 100, 150, 250 mm lengths.

PEEK coated column hardware available to reduce non-specific interactions when analyzing compounds with metal chelating activity.

Phase	Pore Size (Å)	Particle Size (µm)	Surface Area	pH
SCX	120	3, 5	350	1-10

For more information about this product visit [www.sge.com](http://www.sge.com) or contact [techsupport@sge.com](mailto:techsupport@sge.com).





Part Number	Part Description and Detail
2SCX-03M03P	SCX x 3 µm Particle Size x 120 Å Pore Size, 100 mm Length x 3.0 mm ID, PEEK Coated ProteCol HPLC Column
2SCX-03M03PG	SCX x 3 µm Particle Size x 120 Å Pore Size, 100 mm Length x 3.0 mm ID, PEEK Coated with Guard ProteCol HPLC Column
2SCX-03M46P	SCX x 3 µm Particle Size x 120 Å Pore Size, 100 mm Length x 4.6 mm ID, PEEK Coated ProteCol HPLC Column
2SCX-03M46PG	SCX x 3 µm Particle Size x 120 Å Pore Size, 100 mm Length x 4.6 mm ID, PEEK Coated with Guard ProteCol HPLC Column
2SCX-03N02P	SCX x 3 µm Particle Size x 120 Å Pore Size, 150 mm Length x 2.1 mm ID, PEEK Coated ProteCol HPLC Column
2SCX-03N02PG	SCX x 3 µm Particle Size x 120 Å Pore Size, 150 mm Length x 2.1 mm ID, PEEK Coated with Guard ProteCol HPLC Column
2SCX-03N03P	SCX x 3 µm Particle Size x 120 Å Pore Size, 150 mm Length x 3.0 mm ID, PEEK Coated ProteCol HPLC Column
2SCX-03N03PG	SCX x 3 µm Particle Size x 120 Å Pore Size, 150 mm Length x 3.0 mm ID, PEEK Coated with Guard ProteCol HPLC Column
2SCX-03N46P	SCX x 3 µm Particle Size x 120 Å Pore Size, 150 mm Length x 4.6 mm ID, PEEK Coated ProteCol HPLC Column
2SCX-03N46PG	SCX x 3 µm Particle Size x 120 Å Pore Size, 150 mm Length x 4.6 mm ID, PEEK Coated with Guard ProteCol HPLC Column
2SCX-05L02P	SCX x 5 µm Particle Size x 120 Å Pore Size, 50 mm Length x 2.1 mm ID, PEEK Coated ProteCol HPLC Column
2SCX-05L02PG	SCX x 5 µm Particle Size x 120 Å Pore Size, 50 mm Length x 2.1 mm ID, PEEK Coated with Guard ProteCol HPLC Column
2SCX-05L03P	SCX x 5 µm Particle Size x 120 Å Pore Size, 50 mm Length x 3.0 mm ID, PEEK Coated ProteCol HPLC Column
2SCX-05L03PG	SCX x 5 µm Particle Size x 120 Å Pore Size, 50 mm Length x 3.0 mm ID, PEEK Coated with Guard ProteCol HPLC Column
2SCX-05L46P	SCX x 5 µm Particle Size x 120 Å Pore Size, 50 mm Length x 4.6 mm ID, PEEK Coated ProteCol HPLC Column
2SCX-05L46PG	SCX x 5 µm Particle Size x 120 Å Pore Size, 50 mm Length x 4.6 mm ID, PEEK Coated with Guard ProteCol HPLC Column
2SCX-05M02P	SCX x 5 µm Particle Size x 120 Å Pore Size, 100 mm Length x 2.1 mm ID, PEEK Coated ProteCol HPLC Column
2SCX-05M02PG	SCX x 5 µm Particle Size x 120 Å Pore Size, 100 mm Length x 2.1 mm ID, PEEK Coated with Guard ProteCol HPLC Column
2SCX-05M03P	SCX x 5 µm Particle Size x 120 Å Pore Size, 100 mm Length x 3.0 mm ID, PEEK Coated ProteCol HPLC Column
2SCX-05M03PG	SCX x 5 µm Particle Size x 120 Å Pore Size, 100 mm Length x 3.0 mm ID, PEEK Coated with Guard ProteCol HPLC Column
2SCX-05M46P	SCX x 5 µm Particle Size x 120 Å Pore Size, 100 mm Length x 4.6 mm ID, PEEK Coated ProteCol HPLC Column
2SCX-05M46PG	SCX x 5 µm Particle Size x 120 Å Pore Size, 100 mm Length x 4.6 mm ID, PEEK Coated with Guard ProteCol HPLC Column
2SCX-05N02P	SCX x 5 µm Particle Size x 120 Å Pore Size, 150 mm Length x 2.1 mm ID, PEEK Coated ProteCol HPLC Column
2SCX-05N02PG	SCX x 5 µm Particle Size x 120 Å Pore Size, 150 mm Length x 2.1 mm ID, PEEK Coated with Guard ProteCol HPLC Column
2SCX-05N03P	SCX x 5 µm Particle Size x 120 Å Pore Size, 150 mm Length x 3.0 mm ID, PEEK Coated ProteCol HPLC Column
2SCX-05N03PG	SCX x 5 µm Particle Size x 120 Å Pore Size, 150 mm Length x 3.0 mm ID, PEEK Coated with Guard ProteCol HPLC Column
2SCX-05N46P	SCX x 5 µm Particle Size x 120 Å Pore Size, 150 mm Length x 4.6 mm ID, PEEK Coated ProteCol HPLC Column
2SCX-05N46PG	SCX x 5 µm Particle Size x 120 Å Pore Size, 150 mm Length x 4.6 mm ID, PEEK Coated with Guard ProteCol HPLC Column
2SCX-05R02P	SCX x 5 µm Particle Size x 120 Å Pore Size, 250 mm Length x 2.1 mm ID, PEEK Coated ProteCol HPLC Column
2SCX-05R02PG	SCX x 5 µm Particle Size x 120 Å Pore Size, 250 mm Length x 2.1 mm ID, PEEK Coated with Guard ProteCol HPLC Column
2SCX-05R03P	SCX x 5 µm Particle Size x 120 Å Pore Size, 250 mm Length x 3.0 mm ID, PEEK Coated ProteCol HPLC Column
2SCX-05R03PG	SCX x 5 µm Particle Size x 120 Å Pore Size, 250 mm Length x 3.0 mm ID, PEEK Coated with Guard ProteCol HPLC Column
2SCX-05R46P	SCX x 5 µm Particle Size x 120 Å Pore Size, 250 mm Length x 4.6 mm ID, PEEK Coated ProteCol HPLC Column
2SCX-05R46PG	SCX x 5 µm Particle Size x 120 Å Pore Size, 250 mm Length x 4.6 mm ID, PEEK Coated with Guard ProteCol HPLC Column

For more information visit [www.sge.com](http://www.sge.com) or contact [techsupport@sge.com](mailto:techsupport@sge.com).



## Separations | HPLC Column ProteCol® Ultra

Turn Imagination into Results

Complementing the ProteCol® analytical range. These columns use 1.8 µm particles for UHPLC use.

### Features and Benefits

Specifically designed for UHPLC use, sub 2 micron phases enable use up to 19000 psi.

### Recommended Applications

UHPLC.

---

### Product Specifications

The following phases are available in 2 mm ID columns, with 50, 100, and 150 mm lengths:

- ProteCol Ultra C18.
- ProteCol Ultra C8.
- ProteCol Ultra Amino.
- ProteCol Ultra Cyano.
- ProteCol Ultra HILIC FL.
- ProteCol Ultra HILIC PI.
- ProteCol Ultra PFP.
- ProteCol Ultra Phenyl.
- ProteCol Ultra Phenyl Hexyl.
- ProteCol Ultra Polar.
- ProteCol Ultra SCX.



For more information about this product visit [www.sge.com](http://www.sge.com) or contact [techsupport@sge.com](mailto:techsupport@sge.com).

# Separations | HPLC Column ProteCol® Ultra

## Turn Imagination into Results

Part Number	Part Description and Detail
<b>Ultra Amino</b>	
2UAM-18L02U	Ultra Amino x 1.8 µm Particle Size x 120 Å Pore Size, 50 mm Length x 2.1 mm ID, Ultra High Pressure Hardware ProteCol HPLC Column
2UAM-18M02U	Ultra Amino x 1.8 µm Particle Size x 120 Å Pore Size, 100 mm Length x 2.1 mm ID, Ultra High Pressure Hardware ProteCol HPLC Column
2UAM-18N02U	Ultra Amino x 1.8 µm Particle Size x 120 Å Pore Size, 150 mm Length x 2.1 mm ID, Ultra High Pressure Hardware ProteCol HPLC Column
<b>Ultra C8</b>	
2UC8-18L02U	Ultra C8 x 1.8 µm Particle Size x 120 Å Pore Size, 50 mm Length x 2.1 mm ID, Ultra High Pressure Hardware ProteCol HPLC Column
2UC8-18M02U	Ultra C8 x 1.8 µm Particle Size x 120 Å Pore Size, 100 mm Length x 2.1 mm ID, Ultra High Pressure Hardware ProteCol HPLC Column
2UC8-18N02U	Ultra C8 x 1.8 µm Particle Size x 120 Å Pore Size, 150 mm Length x 2.1 mm ID, Ultra High Pressure Hardware ProteCol HPLC Column
<b>Ultra C18</b>	
2UC18-18L02U	Ultra C18 x 1.8 µm Particle Size x 120 Å Pore Size, 50 mm Length x 2.1 mm ID, Ultra High Pressure Hardware ProteCol HPLC Column
2UC18-18M02U	Ultra C18 x 1.8 µm Particle Size x 120 Å Pore Size, 100 mm Length x 2.1 mm ID, Ultra High Pressure Hardware ProteCol HPLC Column
2UC18-18N02U	Ultra C18 x 1.8 µm Particle Size x 120 Å Pore Size, 150 mm Length x 2.1 mm ID, Ultra High Pressure Hardware ProteCol HPLC Column
<b>Ultra Cyano</b>	
2UCN-18L02U	Ultra Cyano x 1.8 µm Particle Size x 120 Å Pore Size, 50 mm Length x 2.1 mm ID, Ultra High Pressure Hardware ProteCol HPLC Column
2UCN-18M02U	Ultra Cyano x 1.8 µm Particle Size x 120 Å Pore Size, 100 mm Length x 2.1 mm ID, Ultra High Pressure Hardware ProteCol HPLC Column
2UCN-18N02U	Ultra Cyano x 1.8 µm Particle Size x 120 Å Pore Size, 150 mm Length x 2.1 mm ID, Ultra High Pressure Hardware ProteCol HPLC Column
<b>Ultra HILIC FL</b>	
2UHL8-18L02U	Ultra HILIC FL x 1.8 µm Particle Size x 120 Å Pore Size, 50 mm Length x 2.1 mm ID, Ultra High Pressure Hardware ProteCol HPLC Column
2UHL8-18M02U	Ultra HILIC FL x 1.8 µm Particle Size x 120 Å Pore Size, 100 mm Length x 2.1 mm ID, Ultra High Pressure Hardware ProteCol HPLC Column
2UHL8-18N02U	Ultra HILIC FL x 1.8 µm Particle Size x 120 Å Pore Size, 150 mm Length x 2.1 mm ID, Ultra High Pressure Hardware ProteCol HPLC Column
<b>Ultra HILIC PI</b>	
2UHL7-18L02U	Ultra HILIC PI x 1.8 µm Particle Size x 120 Å Pore Size, 50 mm Length x 2.1 mm ID, Ultra High Pressure Hardware ProteCol HPLC Column
2UHL7-18M02U	Ultra HILIC PI x 1.8 µm Particle Size x 120 Å Pore Size, 100 mm Length x 2.1 mm ID, Ultra High Pressure Hardware ProteCol HPLC Column
2UHL7-18N02U	Ultra HILIC PI x 1.8 µm Particle Size x 120 Å Pore Size, 150 mm Length x 2.1 mm ID, Ultra High Pressure Hardware ProteCol HPLC Column
<b>Ultra PFP</b>	
2UPFP-18L02U	Ultra PFP x 1.8 µm Particle Size x 120 Å Pore Size, 50 mm Length x 2.1 mm ID, Ultra High Pressure Hardware ProteCol HPLC Column
2UPFP-18M02U	Ultra PFP x 1.8 µm Particle Size x 120 Å Pore Size, 100 mm Length x 2.1 mm ID, Ultra High Pressure Hardware ProteCol HPLC Column
2UPFP-18N02U	Ultra PFP x 1.8 µm Particle Size x 120 Å Pore Size, 150 mm Length x 2.1 mm ID, Ultra High Pressure Hardware ProteCol HPLC Column
<b>Ultra Phenyl</b>	
2UPH-18L02U	Ultra Phenyl x 1.8 µm Particle Size x 120 Å Pore Size, 50 mm Length x 2.1 mm ID, Ultra High Pressure Hardware ProteCol HPLC Column
2UPH-18M02U	Ultra Phenyl x 1.8 µm Particle Size x 120 Å Pore Size, 100 mm Length x 2.1 mm ID, Ultra High Pressure Hardware ProteCol HPLC Column
2UPH-18N02U	Ultra Phenyl x 1.8 µm Particle Size x 120 Å Pore Size, 150 mm Length x 2.1 mm ID, Ultra High Pressure Hardware ProteCol HPLC Column
<b>Ultra Phenyl Hexyl</b>	
2UNH4-18L02U	Ultra Phenyl Hexyl x 1.8 µm Particle Size x 120 Å Pore Size, 50 mm Length x 2.1 mm ID, Ultra High Pressure Hardware ProteCol HPLC Column
2UNH4-18M02U	Ultra Phenyl Hexyl x 1.8 µm Particle Size x 120 Å Pore Size, 100 mm Length x 2.1 mm ID, Ultra High Pressure Hardware ProteCol HPLC Column
2UNH4-18N02U	Ultra Phenyl Hexyl x 1.8 µm Particle Size x 120 Å Pore Size, 150 mm Length x 2.1 mm ID, Ultra High Pressure Hardware ProteCol HPLC Column
<b>Ultra Polar C18</b>	
2UPOL-18L02U	Ultra Polar C18 x 1.8 µm Particle Size x 120 Å Pore Size, 50 mm Length x 2.1 mm ID, Ultra High Pressure Hardware ProteCol HPLC Column
2UPOL-18M02U	Ultra Polar C19 x 1.8 µm Particle Size x 120 Å Pore Size, 100 mm Length x 2.1 mm ID, Ultra High Pressure Hardware ProteCol HPLC Column
2UPOL-18N02U	Ultra Polar C20 x 1.8 µm Particle Size x 120 Å Pore Size, 150 mm Length x 2.1 mm ID, Ultra High Pressure Hardware ProteCol HPLC Column
<b>Ultra SCX</b>	
2USCX-18L02U	Ultra SCX x 1.8 µm Particle Size x 120 Å Pore Size, 50 mm Length x 2.1 mm ID, Ultra High Pressure Hardware ProteCol HPLC Column
2USCX-18M02U	Ultra SCX x 1.8 µm Particle Size x 120 Å Pore Size, 100 mm Length x 2.1 mm ID, Ultra High Pressure Hardware ProteCol HPLC Column
2USCX-18N02U	Ultra SCX x 1.8 µm Particle Size x 120 Å Pore Size, 150 mm Length x 2.1 mm ID, Ultra High Pressure Hardware ProteCol HPLC Column

For more information about this product visit [www.sge.com](http://www.sge.com) or contact [techsupport@sge.com](mailto:techsupport@sge.com).

# Separations | HPLC Column ProteCol® Cyano

Turn Imagination into Results

High quality phases and a variety of hardware options provide a perfect match for all your separation needs.

## Features and Benefits

Provides chromatographic retention both in normal and reversed phase separation due to its moderate polarity.

## Recommended Applications

Separation of flavonoids, extraction of polar compounds from non-polar samples as well as the analysis of samples containing analytes with a wide range of hydrophobicity.

## Product Specifications

2.1, 3, and 4.6 mm ID columns available in 50, 100, 150, 250 mm lengths.

Phase	Pore Size (Å)	Particle Size (µm)	Surface Area	% Carbon Load	USP Code
Cyano	120	5	300	5	L10

For more information about this product visit [www.sge.com](http://www.sge.com) or contact [techsupport@sge.com](mailto:techsupport@sge.com).



# Separations | HPLC Column ProteCol® Cyano

## Turn Imagination into Results

Part Number	Part Description and Detail
<b>Stainless Steel</b>	
2CN-05L02S	Cyano x 5 µm Particle Size x 120 Å Pore Size, 50 mm Length x 2.1 mm ID, Stainless Steel ProteCol HPLC Column
2CN-05L02SG	Cyano x 5 µm Particle Size x 120 Å Pore Size, 50 mm Length x 2.1 mm ID, Stainless Steel with Guard ProteCol HPLC Column
2CN-05L03S	Cyano x 5 µm Particle Size x 120 Å Pore Size, 50 mm Length x 3.0 mm ID, Stainless Steel ProteCol HPLC Column
2CN-05L03SG	Cyano x 5 µm Particle Size x 120 Å Pore Size, 50 mm Length x 3.0 mm ID, Stainless Steel with Guard ProteCol HPLC Column
2CN-05L46S	Cyano x 5 µm Particle Size x 120 Å Pore Size, 50 mm Length x 4.6 mm ID, Stainless Steel ProteCol HPLC Column
2CN-05L46SG	Cyano x 5 µm Particle Size x 120 Å Pore Size, 50 mm Length x 4.6 mm ID, Stainless Steel with Guard ProteCol HPLC Column
2CN-05M02S	Cyano x 5 µm Particle Size x 120 Å Pore Size, 100 mm Length x 2.1 mm ID, Stainless Steel ProteCol HPLC Column
2CN-05M02SG	Cyano x 5 µm Particle Size x 120 Å Pore Size, 100 mm Length x 2.1 mm ID, Stainless Steel with Guard ProteCol HPLC Column
2CN-05M03S	Cyano x 5 µm Particle Size x 120 Å Pore Size, 100 mm Length x 3.0 mm ID, Stainless Steel ProteCol HPLC Column
2CN-05M03SG	Cyano x 5 µm Particle Size x 120 Å Pore Size, 100 mm Length x 3.0 mm ID, Stainless Steel with Guard ProteCol HPLC Column
2CN-05M46S	Cyano x 5 µm Particle Size x 120 Å Pore Size, 100 mm Length x 4.6 mm ID, Stainless Steel ProteCol HPLC Column
2CN-05M46SG	Cyano x 5 µm Particle Size x 120 Å Pore Size, 100 mm Length x 4.6 mm ID, Stainless Steel with Guard ProteCol HPLC Column
2CN-05N02S	Cyano x 5 µm Particle Size x 120 Å Pore Size, 150 mm Length x 2.1 mm ID, Stainless Steel ProteCol HPLC Column
2CN-05N02SG	Cyano x 5 µm Particle Size x 120 Å Pore Size, 150 mm Length x 2.1 mm ID, Stainless Steel with Guard ProteCol HPLC Column
2CN-05N03S	Cyano x 5 µm Particle Size x 120 Å Pore Size, 150 mm Length x 3.0 mm ID, Stainless Steel ProteCol HPLC Column
2CN-05N03SG	Cyano x 5 µm Particle Size x 120 Å Pore Size, 150 mm Length x 3.0 mm ID, Stainless Steel with Guard ProteCol HPLC Column
2CN-05N46S	Cyano x 5 µm Particle Size x 120 Å Pore Size, 150 mm Length x 4.6 mm ID, Stainless Steel ProteCol HPLC Column
2CN-05N46SG	Cyano x 5 µm Particle Size x 120 Å Pore Size, 150 mm Length x 4.6 mm ID, Stainless Steel with Guard ProteCol HPLC Column
2CN-05R02S	Cyano x 5 µm Particle Size x 120 Å Pore Size, 250 mm Length x 2.1 mm ID, Stainless Steel ProteCol HPLC Column
2CN-05R02SG	Cyano x 5 µm Particle Size x 120 Å Pore Size, 250 mm Length x 2.1 mm ID, Stainless Steel with Guard ProteCol HPLC Column
2CN-05R03S	Cyano x 5 µm Particle Size x 120 Å Pore Size, 250 mm Length x 3.0 mm ID, Stainless Steel ProteCol HPLC Column
2CN-05R03SG	Cyano x 5 µm Particle Size x 120 Å Pore Size, 250 mm Length x 3.0 mm ID, Stainless Steel with Guard ProteCol HPLC Column
2CN-05R46S	Cyano x 5 µm Particle Size x 120 Å Pore Size, 250 mm Length x 4.6 mm ID, Stainless Steel ProteCol HPLC Column
2CN-05R46SG	Cyano x 5 µm Particle Size x 120 Å Pore Size, 250 mm Length x 4.6 mm ID, Stainless Steel with Guard ProteCol HPLC Column
<b>PEEK Coated</b>	
2CN-05L02P	Cyano x 5 µm Particle Size x 120 Å Pore Size, 50 mm Length x 2.1 mm ID, PEEK Coated ProteCol HPLC Column
2CN-05L02PG	Cyano x 5 µm Particle Size x 120 Å Pore Size, 50 mm Length x 2.1 mm ID, PEEK Coated with Guard ProteCol HPLC Column
2CN-05L03P	Cyano x 5 µm Particle Size x 120 Å Pore Size, 50 mm Length x 3.0 mm ID, PEEK Coated ProteCol HPLC Column
2CN-05L03PG	Cyano x 5 µm Particle Size x 120 Å Pore Size, 50 mm Length x 3.0 mm ID, PEEK Coated with Guard ProteCol HPLC Column
2CN-05L46P	Cyano x 5 µm Particle Size x 120 Å Pore Size, 50 mm Length x 4.6 mm ID, PEEK Coated ProteCol HPLC Column
2CN-05L46PG	Cyano x 5 µm Particle Size x 120 Å Pore Size, 50 mm Length x 4.6 mm ID, PEEK Coated with Guard ProteCol HPLC Column
2CN-05M02P	Cyano x 5 µm Particle Size x 120 Å Pore Size, 100 mm Length x 2.1 mm ID, PEEK Coated ProteCol HPLC Column
2CN-05M02PG	Cyano x 5 µm Particle Size x 120 Å Pore Size, 100 mm Length x 2.1 mm ID, PEEK Coated with Guard ProteCol HPLC Column
2CN-05M03P	Cyano x 5 µm Particle Size x 120 Å Pore Size, 100 mm Length x 3.0 mm ID, PEEK Coated ProteCol HPLC Column
2CN-05M03PG	Cyano x 5 µm Particle Size x 120 Å Pore Size, 100 mm Length x 3.0 mm ID, PEEK Coated with Guard ProteCol HPLC Column
2CN-05M46P	Cyano x 5 µm Particle Size x 120 Å Pore Size, 100 mm Length x 4.6 mm ID, PEEK Coated ProteCol HPLC Column
2CN-05M46PG	Cyano x 5 µm Particle Size x 120 Å Pore Size, 100 mm Length x 4.6 mm ID, PEEK Coated with Guard ProteCol HPLC Column
2CN-05N02P	Cyano x 5 µm Particle Size x 120 Å Pore Size, 150 mm Length x 2.1 mm ID, PEEK Coated ProteCol HPLC Column
2CN-05N02PG	Cyano x 5 µm Particle Size x 120 Å Pore Size, 150 mm Length x 2.1 mm ID, PEEK Coated with Guard ProteCol HPLC Column
2CN-05N03P	Cyano x 5 µm Particle Size x 120 Å Pore Size, 150 mm Length x 3.0 mm ID, PEEK Coated ProteCol HPLC Column
2CN-05N03PG	Cyano x 5 µm Particle Size x 120 Å Pore Size, 150 mm Length x 3.0 mm ID, PEEK Coated with Guard ProteCol HPLC Column
2CN-05N46P	Cyano x 5 µm Particle Size x 120 Å Pore Size, 150 mm Length x 4.6 mm ID, PEEK Coated ProteCol HPLC Column
2CN-05N46PG	Cyano x 5 µm Particle Size x 120 Å Pore Size, 150 mm Length x 4.6 mm ID, PEEK Coated with Guard ProteCol HPLC Column
2CN-05R02P	Cyano x 5 µm Particle Size x 120 Å Pore Size, 250 mm Length x 2.1 mm ID, PEEK Coated ProteCol HPLC Column
2CN-05R02PG	Cyano x 5 µm Particle Size x 120 Å Pore Size, 250 mm Length x 2.1 mm ID, PEEK Coated with Guard ProteCol HPLC Column
2CN-05R03P	Cyano x 5 µm Particle Size x 120 Å Pore Size, 250 mm Length x 3.0 mm ID, PEEK Coated ProteCol HPLC Column
2CN-05R03PG	Cyano x 5 µm Particle Size x 120 Å Pore Size, 250 mm Length x 3.0 mm ID, PEEK Coated with Guard ProteCol HPLC Column
2CN-05R46P	Cyano x 5 µm Particle Size x 120 Å Pore Size, 250 mm Length x 4.6 mm ID, PEEK Coated ProteCol HPLC Column
2CN-05R46PG	Cyano x 5 µm Particle Size x 120 Å Pore Size, 250 mm Length x 4.6 mm ID, PEEK Coated with Guard ProteCol HPLC Column

For more information about this product visit [www.sge.com](http://www.sge.com) or contact [techsupport@sge.com](mailto:techsupport@sge.com).

# Separations | HPLC Column ProteCol® Silica

## Turn Imagination into Results

High quality phases and a variety of hardware options provide a perfect match for all your separation needs.

### Features and Benefits

- High durability and extended acidic and alkaline resistance.
- High surface area and mechanical strength.

### Recommended Applications

Separation of very hydrophobic molecules.

### Product Specifications

2.1, 3, and 4.6 mm ID columns available in 50, 100, 150, 250 mm lengths.

Phase	Pore Size (Å)	Particle Size (µm)	Surface Area	% Carbon Load	USP Code
Silica	120	3, 5, 10	300	0	L3

For more information about this product visit [www.sge.com](http://www.sge.com) or contact [techsupport@sge.com](mailto:techsupport@sge.com).







Part Number	Part Description and Detail
2SIL-03M03P	Silica x 3 µm Particle Size x 120 Å Pore Size, 100 mm Length x 3.0 mm ID, PEEK Coated ProteCol HPLC Column
2SIL-03M03PG	Silica x 3 µm Particle Size x 120 Å Pore Size, 100 mm Length x 3.0 mm ID, PEEK Coated with Guard ProteCol HPLC Column
2SIL-03M46P	Silica x 3 µm Particle Size x 120 Å Pore Size, 100 mm Length x 4.6 mm ID, PEEK Coated ProteCol HPLC Column
2SIL-03M46PG	Silica x 3 µm Particle Size x 120 Å Pore Size, 100 mm Length x 4.6 mm ID, PEEK Coated with Guard ProteCol HPLC Column
2SIL-03N02P	Silica x 3 µm Particle Size x 120 Å Pore Size, 150 mm Length x 2.1 mm ID, PEEK Coated ProteCol HPLC Column
2SIL-03N02PG	Silica x 3 µm Particle Size x 120 Å Pore Size, 150 mm Length x 2.1 mm ID, PEEK Coated with Guard ProteCol HPLC Column
2SIL-03N03P	Silica x 3 µm Particle Size x 120 Å Pore Size, 150 mm Length x 3.0 mm ID, PEEK Coated ProteCol HPLC Column
2SIL-03N03PG	Silica x 3 µm Particle Size x 120 Å Pore Size, 150 mm Length x 3.0 mm ID, PEEK Coated with Guard ProteCol HPLC Column
2SIL-03N46P	Silica x 3 µm Particle Size x 120 Å Pore Size, 150 mm Length x 4.6 mm ID, PEEK Coated ProteCol HPLC Column
2SIL-03N46PG	Silica x 3 µm Particle Size x 120 Å Pore Size, 150 mm Length x 4.6 mm ID, PEEK Coated with Guard ProteCol HPLC Column
2SIL-05L02P	Silica x 5 µm Particle Size x 120 Å Pore Size, 50 mm Length x 2.1 mm ID, PEEK Coated ProteCol HPLC Column
2SIL-05L02PG	Silica x 5 µm Particle Size x 120 Å Pore Size, 50 mm Length x 2.1 mm ID, PEEK Coated with Guard ProteCol HPLC Column
2SIL-05L03P	Silica x 5 µm Particle Size x 120 Å Pore Size, 50 mm Length x 3.0 mm ID, PEEK Coated ProteCol HPLC Column
2SIL-05L03PG	Silica x 5 µm Particle Size x 120 Å Pore Size, 50 mm Length x 3.0 mm ID, PEEK Coated with Guard ProteCol HPLC Column
2SIL-05L46P	Silica x 5 µm Particle Size x 120 Å Pore Size, 50 mm Length x 4.6 mm ID, PEEK Coated ProteCol HPLC Column
2SIL-05L46PG	Silica x 5 µm Particle Size x 120 Å Pore Size, 50 mm Length x 4.6 mm ID, PEEK Coated with Guard ProteCol HPLC Column
2SIL-05M02P	Silica x 5 µm Particle Size x 120 Å Pore Size, 100 mm Length x 2.1 mm ID, PEEK Coated ProteCol HPLC Column
2SIL-05M02PG	Silica x 5 µm Particle Size x 120 Å Pore Size, 100 mm Length x 2.1 mm ID, PEEK Coated with Guard ProteCol HPLC Column
2SIL-05M03P	Silica x 5 µm Particle Size x 120 Å Pore Size, 100 mm Length x 3.0 mm ID, PEEK Coated ProteCol HPLC Column
2SIL-05M03PG	Silica x 5 µm Particle Size x 120 Å Pore Size, 100 mm Length x 3.0 mm ID, PEEK Coated with Guard ProteCol HPLC Column
2SIL-05M46P	Silica x 5 µm Particle Size x 120 Å Pore Size, 100 mm Length x 4.6 mm ID, PEEK Coated ProteCol HPLC Column
2SIL-05M46PG	Silica x 5 µm Particle Size x 120 Å Pore Size, 100 mm Length x 4.6 mm ID, PEEK Coated with Guard ProteCol HPLC Column
2SIL-05N02P	Silica x 5 µm Particle Size x 120 Å Pore Size, 150 mm Length x 2.1 mm ID, PEEK Coated ProteCol HPLC Column
2SIL-05N02PG	Silica x 5 µm Particle Size x 120 Å Pore Size, 150 mm Length x 2.1 mm ID, PEEK Coated with Guard ProteCol HPLC Column
2SIL-05N03P	Silica x 5 µm Particle Size x 120 Å Pore Size, 150 mm Length x 3.0 mm ID, PEEK Coated ProteCol HPLC Column
2SIL-05N03PG	Silica x 5 µm Particle Size x 120 Å Pore Size, 150 mm Length x 3.0 mm ID, PEEK Coated with Guard ProteCol HPLC Column
2SIL-05N46P	Silica x 5 µm Particle Size x 120 Å Pore Size, 150 mm Length x 4.6 mm ID, PEEK Coated ProteCol HPLC Column
2SIL-05N46PG	Silica x 5 µm Particle Size x 120 Å Pore Size, 150 mm Length x 4.6 mm ID, PEEK Coated with Guard ProteCol HPLC Column
2SIL-05R02P	Silica x 5 µm Particle Size x 120 Å Pore Size, 250 mm Length x 2.1 mm ID, PEEK Coated ProteCol HPLC Column
2SIL-05R02PG	Silica x 5 µm Particle Size x 120 Å Pore Size, 250 mm Length x 2.1 mm ID, PEEK Coated with Guard ProteCol HPLC Column
2SIL-05R03P	Silica x 5 µm Particle Size x 120 Å Pore Size, 250 mm Length x 3.0 mm ID, PEEK Coated ProteCol HPLC Column
2SIL-05R03PG	Silica x 5 µm Particle Size x 120 Å Pore Size, 250 mm Length x 3.0 mm ID, PEEK Coated with Guard ProteCol HPLC Column
2SIL-05R46P	Silica x 5 µm Particle Size x 120 Å Pore Size, 250 mm Length x 4.6 mm ID, PEEK Coated ProteCol HPLC Column
2SIL-05R46PG	Silica x 5 µm Particle Size x 120 Å Pore Size, 250 mm Length x 4.6 mm ID, PEEK Coated with Guard ProteCol HPLC Column

For more information visit [www.sge.com](http://www.sge.com) or contact [techsupport@sge.com](mailto:techsupport@sge.com).



# Separations | HPLC Column ProteCol® Amino

## Turn Imagination into Results

High quality phases and a variety of hardware options provide a perfect match for all your separation needs.

### Features and Benefits

Allows basic compound separation in normal phase and carbohydrate analysis.

### Recommended Applications

Reverse phase carbohydrate analysis and normal phase basic compound separations.

---

### Product Specifications

2.1, 3, and 4.6 mm ID columns available in 50, 100, 150, 250 mm lengths.

Phase	Pore Size (Å)	Particle Size (µm)	Surface Area	% Carbon Load	USP Code
Amino	120	5	350	4.0	L8

For more information about this product visit [www.sge.com](http://www.sge.com) or contact [techsupport@sge.com](mailto:techsupport@sge.com).



# Separations | HPLC Column ProteCol® Amino

## Turn Imagination into Results

Part Number	Part Description and Detail
<b>Stainless Steel</b>	
2AM-05L02S	Amino x 5 µm Particle Size x 120Å Pore Size, 50 mm Length x 2.1 mm ID, Stainless Steel ProteCol HPLC Column
2AM-05L02SG	Amino x 5 µm Particle Size x 120Å Pore Size, 50 mm Length x 2.1 mm ID, Stainless Steel with Guard ProteCol HPLC Column
2AM-05L03S	Amino x 5 µm Particle Size x 120Å Pore Size, 50 mm Length x 3.0 mm ID, Stainless Steel ProteCol HPLC Column
2AM-05L03SG	Amino x 5 µm Particle Size x 120Å Pore Size, 50 mm Length x 3.0 mm ID, Stainless Steel with Guard ProteCol HPLC Column
2AM-05L46S	Amino x 5 µm Particle Size x 120Å Pore Size, 50 mm Length x 4.6 mm ID, Stainless Steel ProteCol HPLC Column
2AM-05L46SG	Amino x 5 µm Particle Size x 120Å Pore Size, 50 mm Length x 4.6 mm ID, Stainless Steel with Guard ProteCol HPLC Column
2AM-05M02S	Amino x 5 µm Particle Size x 120Å Pore Size, 100 mm Length x 2.1 mm ID, Stainless Steel ProteCol HPLC Column
2AM-05M02SG	Amino x 5 µm Particle Size x 120Å Pore Size, 100 mm Length x 2.1 mm ID, Stainless Steel with Guard ProteCol HPLC Column
2AM-05M03S	Amino x 5 µm Particle Size x 120Å Pore Size, 100 mm Length x 3.0 mm ID, Stainless Steel ProteCol HPLC Column
2AM-05M03SG	Amino x 5 µm Particle Size x 120Å Pore Size, 100 mm Length x 3.0 mm ID, Stainless Steel with Guard ProteCol HPLC Column
2AM-05M46S	Amino x 5 µm Particle Size x 120Å Pore Size, 100 mm Length x 4.6 mm ID, Stainless Steel ProteCol HPLC Column
2AM-05M46SG	Amino x 5 µm Particle Size x 120Å Pore Size, 100 mm Length x 4.6 mm ID, Stainless Steel with Guard ProteCol HPLC Column
2AM-05N02S	Amino x 5 µm Particle Size x 120Å Pore Size, 150 mm Length x 2.1 mm ID, Stainless Steel ProteCol HPLC Column
2AM-05N02SG	Amino x 5 µm Particle Size x 120Å Pore Size, 150 mm Length x 2.1 mm ID, Stainless Steel with Guard ProteCol HPLC Column
2AM-05N03S	Amino x 5 µm Particle Size x 120Å Pore Size, 150 mm Length x 3.0 mm ID, Stainless Steel ProteCol HPLC Column
2AM-05N03SG	Amino x 5 µm Particle Size x 120Å Pore Size, 150 mm Length x 3.0 mm ID, Stainless Steel with Guard ProteCol HPLC Column
2AM-05N46S	Amino x 5 µm Particle Size x 120Å Pore Size, 150 mm Length x 4.6 mm ID, Stainless Steel ProteCol HPLC Column
2AM-05N46SG	Amino x 5 µm Particle Size x 120Å Pore Size, 150 mm Length x 4.6 mm ID, Stainless Steel with Guard ProteCol HPLC Column
2AM-05R02S	Amino x 5 µm Particle Size x 120Å Pore Size, 250 mm Length x 2.1 mm ID, Stainless Steel ProteCol HPLC Column
2AM-05R02SG	Amino x 5 µm Particle Size x 120Å Pore Size, 250 mm Length x 2.1 mm ID, Stainless Steel with Guard ProteCol HPLC Column
2AM-05R03S	Amino x 5 µm Particle Size x 120Å Pore Size, 250 mm Length x 3.0 mm ID, Stainless Steel ProteCol HPLC Column
2AM-05R03SG	Amino x 5 µm Particle Size x 120Å Pore Size, 250 mm Length x 3.0 mm ID, Stainless Steel with Guard ProteCol HPLC Column
2AM-05R46S	Amino x 5 µm Particle Size x 120Å Pore Size, 250 mm Length x 4.6 mm ID, Stainless Steel ProteCol HPLC Column
2AM-05R46SG	Amino x 5 µm Particle Size x 120Å Pore Size, 250 mm Length x 4.6 mm ID, Stainless Steel with Guard ProteCol HPLC Column
<b>PEEK Coated</b>	
2AM-05L02P	Amino x 5 µm Particle Size x 120Å Pore Size, 50 mm Length x 2.1 mm ID, PEEK-Coated ProteCol HPLC Column
2AM-05L02PG	Amino x 5 µm Particle Size x 120Å Pore Size, 50 mm Length x 2.1 mm ID, PEEK-Coated with Guard ProteCol HPLC Column
2AM-05L03P	Amino x 5 µm Particle Size x 120Å Pore Size, 50 mm Length x 3.0 mm ID, PEEK-Coated ProteCol HPLC Column
2AM-05L03PG	Amino x 5 µm Particle Size x 120Å Pore Size, 50 mm Length x 3.0 mm ID, PEEK-Coated with Guard ProteCol HPLC Column
2AM-05L46P	Amino x 5 µm Particle Size x 120Å Pore Size, 50 mm Length x 4.6 mm ID, PEEK-Coated ProteCol HPLC Column
2AM-05L46PG	Amino x 5 µm Particle Size x 120Å Pore Size, 50 mm Length x 4.6 mm ID, PEEK-Coated with Guard ProteCol HPLC Column
2AM-05M02P	Amino x 5 µm Particle Size x 120Å Pore Size, 100 mm Length x 2.1 mm ID, PEEK-Coated ProteCol HPLC Column
2AM-05M02PG	Amino x 5 µm Particle Size x 120Å Pore Size, 100 mm Length x 2.1 mm ID, PEEK-Coated with Guard ProteCol HPLC Column
2AM-05M03P	Amino x 5 µm Particle Size x 120Å Pore Size, 100 mm Length x 3.0 mm ID, PEEK-Coated ProteCol HPLC Column
2AM-05M03PG	Amino x 5 µm Particle Size x 120Å Pore Size, 100 mm Length x 3.0 mm ID, PEEK-Coated with Guard ProteCol HPLC Column
2AM-05M46P	Amino x 5 µm Particle Size x 120Å Pore Size, 100 mm Length x 4.6 mm ID, PEEK-Coated ProteCol HPLC Column
2AM-05M46PG	Amino x 5 µm Particle Size x 120Å Pore Size, 100 mm Length x 4.6 mm ID, PEEK-Coated with Guard ProteCol HPLC Column
2AM-05N02P	Amino x 5 µm Particle Size x 120Å Pore Size, 150 mm Length x 2.1 mm ID, PEEK-Coated ProteCol HPLC Column
2AM-05N02PG	Amino x 5 µm Particle Size x 120Å Pore Size, 150 mm Length x 2.1 mm ID, PEEK-Coated with Guard ProteCol HPLC Column
2AM-05N03P	Amino x 5 µm Particle Size x 120Å Pore Size, 150 mm Length x 3.0 mm ID, PEEK-Coated ProteCol HPLC Column
2AM-05N03PG	Amino x 5 µm Particle Size x 120Å Pore Size, 150 mm Length x 3.0 mm ID, PEEK-Coated with Guard ProteCol HPLC Column
2AM-05N46P	Amino x 5 µm Particle Size x 120Å Pore Size, 150 mm Length x 4.6 mm ID, PEEK-Coated ProteCol HPLC Column
2AM-05N46PG	Amino x 5 µm Particle Size x 120Å Pore Size, 150 mm Length x 4.6 mm ID, PEEK-Coated with Guard ProteCol HPLC Column
2AM-05R02P	Amino x 5 µm Particle Size x 120Å Pore Size, 250 mm Length x 2.1 mm ID, PEEK-Coated ProteCol HPLC Column
2AM-05R02PG	Amino x 5 µm Particle Size x 120Å Pore Size, 250 mm Length x 2.1 mm ID, PEEK-Coated with Guard ProteCol HPLC Column
2AM-05R03P	Amino x 5 µm Particle Size x 120Å Pore Size, 250 mm Length x 3.0 mm ID, PEEK-Coated ProteCol HPLC Column
2AM-05R03PG	Amino x 5 µm Particle Size x 120Å Pore Size, 250 mm Length x 3.0 mm ID, PEEK-Coated with Guard ProteCol HPLC Column
2AM-05R46P	Amino x 5 µm Particle Size x 120Å Pore Size, 250 mm Length x 4.6 mm ID, PEEK-Coated ProteCol HPLC Column
2AM-05R46PG	Amino x 5 µm Particle Size x 120Å Pore Size, 250 mm Length x 4.6 mm ID, PEEK-Coated with Guard ProteCol HPLC Column

For more information about this product visit [www.sge.com](http://www.sge.com) or contact [techsupport@sge.com](mailto:techsupport@sge.com).

## Separations | HPLC Guard Column ProteCol®

Turn Imagination into Results

ProteCol® guard columns are recommended to protect the analytical column, and ensure it performs consistently.

### Features and Benefits

The unique design of SGE's guard column couples directly to the analytical column. The guard column is designed to fit into the back of a PEEK fingertight fitting (provided with the guard column). No further unions are required.

### Recommended Applications

We recommend the use of ProteCol Guard columns to protect the analytical column, and ensure it performs consistently.



---

### Product Specifications

Available in C18, C8, C4, Phenyl Hexyl, Silica, Amino, Cyano, HILIC, Chiral, SCX and PFP phases.

For more information about this product visit [www.sge.com](http://www.sge.com) or contact [techsupport@sge.com](mailto:techsupport@sge.com).

# Separations | HPLC Guard Column ProteCol®

Turn Imagination into Results

Part Number	Part Description and Detail
<b>Stainless Steel</b>	
<b>Amino</b>	
2AM-05G04S	Amino x 5 µm Particle Size x 120 Å Pore Size, 10 mm Length x 4.0 mm ID, Stainless Steel ProteCol HPLC Guard Column PK3
2AM-05G02S	Amino x 5 µm Particle Size x 120 Å Pore Size, 10 mm Length x 2.1 mm ID, Stainless Steel ProteCol HPLC Guard Column PK3
<b>C4G</b>	
2C42-05G01S	C4G x 5 µm Particle Size x 300 Å Pore Size, 10 mm Length x 1.0 mm ID, Stainless Steel ProteCol HPLC Guard Column PK3
2C42-05G10S	C4G x 5 µm Particle Size x 300 Å Pore Size, 10 mm Length x 10 mm ID, Stainless Steel ProteCol HPLC Guard Column PK3
2C42-05G02S	C4G x 5 µm Particle Size x 300 Å Pore Size, 10 mm Length x 2.1 mm ID, Stainless Steel ProteCol HPLC Guard Column PK3
2C42-05G04S	C4G x 5 µm Particle Size x 300 Å Pore Size, 10 mm Length x 4.0 mm ID, Stainless Steel ProteCol HPLC Guard Column PK3
<b>C8H</b>	
2C83-03G01S	C8H x 3 µm Particle Size x 120 Å Pore Size, 10 mm Length x 1.0 mm ID, Stainless Steel ProteCol HPLC Guard Column PK3
2C83-05G01S	C8H x 5 µm Particle Size x 120 Å Pore Size, 10 mm Length x 1.0 mm ID, Stainless Steel ProteCol HPLC Guard Column PK3
2C83-05G10S	C8H x 5 µm Particle Size x 120 Å Pore Size, 10 mm Length x 10 mm ID, Stainless Steel ProteCol HPLC Guard Column PK3
2C83-03G02S	C8H x 3 µm Particle Size x 120 Å Pore Size, 10 mm Length x 2.1 mm ID, Stainless Steel ProteCol HPLC Guard Column PK3
2C83-05G02S	C8H x 5 µm Particle Size x 120 Å Pore Size, 10 mm Length x 2.1 mm ID, Stainless Steel ProteCol HPLC Guard Column PK3
2C83-03G04S	C8H x 3 µm Particle Size x 120 Å Pore Size, 10 mm Length x 4.0 mm ID, Stainless Steel ProteCol HPLC Guard Column PK3
2C83-05G04S	C8H x 5 µm Particle Size x 120 Å Pore Size, 10 mm Length x 4.0 mm ID, Stainless Steel ProteCol HPLC Guard Column PK3
2C82-03G01S	C8H x 3 µm Particle Size x 1000 Å Pore Size, 10 mm Length x 1.0 mm ID, Stainless Steel ProteCol HPLC Guard Column PK3
2C82-03G02S	C8H x 3 µm Particle Size x 1000 Å Pore Size, 10 mm Length x 2.1 mm ID, Stainless Steel ProteCol HPLC Guard Column PK3
2C82-03G04S	C8H x 3 µm Particle Size x 1000 Å Pore Size, 10 mm Length x 4.0 mm ID, Stainless Steel ProteCol HPLC Guard Column PK3
<b>C18G</b>	
2C185-25G01S	C18G x 2.5 µm Particle Size x 120 Å Pore Size, 10 mm Length x 1.0 mm ID, Stainless Steel ProteCol HPLC Guard Column PK3
2C185-03G01S	C18G x 3 µm Particle Size x 120 Å Pore Size, 10 mm Length x 1.0 mm ID, Stainless Steel ProteCol HPLC Guard Column PK3
2C185-05G01S	C18G x 5 µm Particle Size x 120 Å Pore Size, 10 mm Length x 1.0 mm ID, Stainless Steel ProteCol HPLC Guard Column PK3
2C185-05G10S	C18G x 5 µm Particle Size x 120 Å Pore Size, 10 mm Length x 10 mm ID, Stainless Steel ProteCol HPLC Guard Column PK3
2C185-10G10S	C18G x 10 µm Particle Size x 120 Å Pore Size, 10 mm Length x 10 mm ID, Stainless Steel ProteCol HPLC Guard Column PK3
2C185-25G02S	C18G x 2.5 µm Particle Size x 120 Å Pore Size, 10 mm Length x 2.1 mm ID, Stainless Steel ProteCol HPLC Guard Column PK3
2C185-03G02S	C18G x 3 µm Particle Size x 120 Å Pore Size, 10 mm Length x 2.1 mm ID, Stainless Steel ProteCol HPLC Guard Column PK3
2C185-05G02S	C18G x 5 µm Particle Size x 120 Å Pore Size, 10 mm Length x 2.1 mm ID, Stainless Steel ProteCol HPLC Guard Column PK3
2C185-25G04S	C18G x 2.5 µm Particle Size x 120 Å Pore Size, 10 mm Length x 4.0 mm ID, Stainless Steel ProteCol HPLC Guard Column PK3
2C185-03G04S	C18G x 3 µm Particle Size x 120 Å Pore Size, 10 mm Length x 4.0 mm ID, Stainless Steel ProteCol HPLC Guard Column PK3
2C185-05G04S	C18G x 5 µm Particle Size x 120 Å Pore Size, 10 mm Length x 4.0 mm ID, Stainless Steel ProteCol HPLC Guard Column PK3
2C181-03G01S	C18G x 3 µm Particle Size x 200 Å Pore Size, 10 mm Length x 1.0 mm ID, Stainless Steel ProteCol HPLC Guard Column PK3
2C181-03G02S	C18G x 3 µm Particle Size x 200 Å Pore Size, 10 mm Length x 2.1 mm ID, Stainless Steel ProteCol HPLC Guard Column PK3
2C181-03G04S	C18G x 3 µm Particle Size x 200 Å Pore Size, 10 mm Length x 4.0 mm ID, Stainless Steel ProteCol HPLC Guard Column PK3
2C184-03G01S	C18G x 3 µm Particle Size x 300 Å Pore Size, 10 mm Length x 1.0 mm ID, Stainless Steel ProteCol HPLC Guard Column PK3
2C184-05G01S	C18G x 5 µm Particle Size x 300 Å Pore Size, 10 mm Length x 1.0 mm ID, Stainless Steel ProteCol HPLC Guard Column PK3
2C184-05G10S	C18G x 5 µm Particle Size x 300 Å Pore Size, 10 mm Length x 10 mm ID, Stainless Steel ProteCol HPLC Guard Column PK3
2C184-03G02S	C18G x 3 µm Particle Size x 300 Å Pore Size, 10 mm Length x 2.1 mm ID, Stainless Steel ProteCol HPLC Guard Column PK3
2C184-05G02S	C18G x 5 µm Particle Size x 300 Å Pore Size, 10 mm Length x 2.1 mm ID, Stainless Steel ProteCol HPLC Guard Column PK3
2C184-03G04S	C18G x 3 µm Particle Size x 300 Å Pore Size, 10 mm Length x 4.0 mm ID, Stainless Steel ProteCol HPLC Guard Column PK3
2C184-05G04S	C18G x 5 µm Particle Size x 300 Å Pore Size, 10 mm Length x 4.0 mm ID, Stainless Steel ProteCol HPLC Guard Column PK3
<b>C18H</b>	
2C182-03G01S	C18H x 3 µm Particle Size x 120 Å Pore Size, 10 mm Length x 1.0 mm ID, Stainless Steel ProteCol HPLC Guard Column PK3
2C182-03G02S	C18H x 3 µm Particle Size x 120 Å Pore Size, 10 mm Length x 2.1 mm ID, Stainless Steel ProteCol HPLC Guard Column PK3
2C182-03G04S	C18H x 3 µm Particle Size x 120 Å Pore Size, 10 mm Length x 4.0 mm ID, Stainless Steel ProteCol HPLC Guard Column PK3
2C182-05G01S	C18H x 5 µm Particle Size x 120 Å Pore Size, 10 mm Length x 1.0 mm ID, Stainless Steel ProteCol HPLC Guard Column PK3
2C182-05G02S	C18H x 5 µm Particle Size x 120 Å Pore Size, 10 mm Length x 2.1 mm ID, Stainless Steel ProteCol HPLC Guard Column PK3
2C182-05G04S	C18H x 5 µm Particle Size x 120 Å Pore Size, 10 mm Length x 4.0 mm ID, Stainless Steel ProteCol HPLC Guard Column PK3
2C182-05G10S	C18H x 5 µm Particle Size x 120 Å Pore Size, 10 mm Length x 10 mm ID, Stainless Steel ProteCol HPLC Guard Column PK3

Part Number	Part Description and Detail
<b>C18P</b>	
2POL-03G01S	C18P x 3 µm Particle Size x 120 Å Pore Size, 10 mm Length x 1.0 mm ID, Stainless Steel ProteCol HPLC Guard Column PK3
2POL-05G01S	C18P x 5 µm Particle Size x 120 Å Pore Size, 10 mm Length x 1.0 mm ID, Stainless Steel ProteCol HPLC Guard Column PK3
2POL-05G10S	C18P x 5 µm Particle Size x 120 Å Pore Size, 10 mm Length x 10 mm ID, Stainless Steel ProteCol HPLC Guard Column PK3
2POL-03G02S	C18P x 3 µm Particle Size x 120 Å Pore Size, 10 mm Length x 2.1 mm ID, Stainless Steel ProteCol HPLC Guard Column PK3
2POL-05G02S	C18P x 5 µm Particle Size x 120 Å Pore Size, 10 mm Length x 2.1 mm ID, Stainless Steel ProteCol HPLC Guard Column PK3
2POL-03G04S	C18P x 3 µm Particle Size x 120 Å Pore Size, 10 mm Length x 4.0 mm ID, Stainless Steel ProteCol HPLC Guard Column PK3
2POL-05G04S	C18P x 5 µm Particle Size x 120 Å Pore Size, 10 mm Length x 4.0 mm ID, Stainless Steel ProteCol HPLC Guard Column PK3
<b>C18Q</b>	
2C183-03G01S	C18Q x 3 µm Particle Size x 100 Å Pore Size, 10 mm Length x 1.0 mm ID, Stainless Steel ProteCol HPLC Guard Column PK3
2C183-03G02S	C18Q x 3 µm Particle Size x 100 Å Pore Size, 10 mm Length x 2.1 mm ID, Stainless Steel ProteCol HPLC Guard Column PK3
2C183-03G04S	C18Q x 3 µm Particle Size x 100 Å Pore Size, 10 mm Length x 4.0 mm ID, Stainless Steel ProteCol HPLC Guard Column PK3
2C183-05G01S	C18Q x 5 µm Particle Size x 100 Å Pore Size, 10 mm Length x 1.0 mm ID, Stainless Steel ProteCol HPLC Guard Column PK3
2C183-05G02S	C18Q x 5 µm Particle Size x 100 Å Pore Size, 10 mm Length x 2.1 mm ID, Stainless Steel ProteCol HPLC Guard Column PK3
2C183-05G04S	C18Q x 5 µm Particle Size x 100 Å Pore Size, 10 mm Length x 4.0 mm ID, Stainless Steel ProteCol HPLC Guard Column PK3
2C183-05G10S	C18Q x 5 µm Particle Size x 100 Å Pore Size, 10 mm Length x 10 mm ID, Stainless Steel ProteCol HPLC Guard Column PK3
<b>Cyano</b>	
2CN-05G04S	Cyano x 5 µm Particle Size x 120 Å Pore Size, 10 mm Length x 4.0 mm ID, Stainless Steel ProteCol HPLC Guard Column PK3
2CN-05G02S	Cyano x 5 µm Particle Size x 120 Å Pore Size, 10 mm Length x 2.1 mm ID, Stainless Steel ProteCol HPLC Guard Column PK3
<b>Silica</b>	
2SIL-05G04S	Silica x 5 µm Particle Size x 120 Å Pore Size, 10 mm Length x 4.0 mm ID, Stainless Steel ProteCol HPLC Guard Column PK3
2SIL-05G02S	Silica x 5 µm Particle Size x 120 Å Pore Size, 10 mm Length x 2.1 mm ID, Stainless Steel ProteCol HPLC Guard Column PK3
2SIL-03G04S	Silica x 3 µm Particle Size x 120 Å Pore Size, 10 mm Length x 4.0 mm ID, Stainless Steel ProteCol HPLC Guard Column PK3
2SIL-03G02S	Silica x 3 µm Particle Size x 120 Å Pore Size, 10 mm Length x 4.0 mm ID, Stainless Steel ProteCol HPLC Guard Column PK3
<b>PEEKsil</b>	
<b>C4G</b>	
2C42-05G15K	C4G x 5 µm Particle Size x 300 Å Pore Size, 10 mm Length x 150 µm ID, PEEKsil ProteCol HPLC Guard Column PK3
2C42-05G30K	C4G x 5 µm Particle Size x 300 Å Pore Size, 10 mm Length x 300 µm ID, PEEKsil ProteCol HPLC Guard Column PK3
<b>C8H</b>	
2C83-03G30K	C8H x 3 µm Particle Size x 120 Å Pore Size, 10 mm Length x 300 µm ID, PEEKsil ProteCol HPLC Guard Column PK3
2C83-05G30K	C8H x 5 µm Particle Size x 120 Å Pore Size, 10 mm Length x 300 µm ID, PEEKsil ProteCol HPLC Guard Column PK3
2C83-03G15K	C8H x 3 µm Particle Size x 120 Å Pore Size, 10 mm Length x 150 µm ID, PEEKsil ProteCol HPLC Guard Column PK3
2C83-05G15K	C8H x 5 µm Particle Size x 120 Å Pore Size, 10 mm Length x 150 µm ID, PEEKsil ProteCol HPLC Guard Column PK3
2C82-03G15K	C8H x 3 µm Particle Size x 1000 Å Pore Size, 10 mm Length x 150 µm ID, PEEKsil ProteCol HPLC Guard Column PK3
2C82-03G30K	C8H x 3 µm Particle Size x 1000 Å Pore Size, 10 mm Length x 300 µm ID, PEEKsil ProteCol HPLC Guard Column PK3
<b>C18G</b>	
2C185-25G15K	C18G x 2.5 µm Particle Size x 120 Å Pore Size, 10 mm Length x 150 µm ID, PEEKsil ProteCol HPLC Guard Column PK3
2C185-25G30K	C18G x 2.5 µm Particle Size x 120 Å Pore Size, 10 mm Length x 300 µm ID, PEEKsil ProteCol HPLC Guard Column PK3
2C185-03G15K	C18G x 3 µm Particle Size x 120 Å Pore Size, 10 mm Length x 150 µm ID, PEEKsil ProteCol HPLC Guard Column PK3
2C185-03G30K	C18G x 3 µm Particle Size x 120 Å Pore Size, 10 mm Length x 300 µm ID, PEEKsil ProteCol HPLC Guard Column PK3
2C185-05G15K	C18G x 5 µm Particle Size x 120 Å Pore Size, 10 mm Length x 150 µm ID, PEEKsil ProteCol HPLC Guard Column PK3
2C185-05G30K	C18G x 5 µm Particle Size x 120 Å Pore Size, 10 mm Length x 300 µm ID, PEEKsil ProteCol HPLC Guard Column PK3
2C181-03G15K	C18G x 3 µm Particle Size x 200 Å Pore Size, 10 mm Length x 150 µm ID, PEEKsil ProteCol HPLC Guard Column PK3
2C181-03G30K	C18G x 3 µm Particle Size x 200 Å Pore Size, 10 mm Length x 300 µm ID, PEEKsil ProteCol HPLC Guard Column PK3
2C184-03G15K	C18G x 3 µm Particle Size x 300 Å Pore Size, 10 mm Length x 150 µm ID, PEEKsil ProteCol HPLC Guard Column PK3
2C184-05G15K	C18G x 5 µm Particle Size x 300 Å Pore Size, 10 mm Length x 150 µm ID, PEEKsil ProteCol HPLC Guard Column PK3
2C184-03G30K	C18G x 3 µm Particle Size x 300 Å Pore Size, 10 mm Length x 300 µm ID, PEEKsil ProteCol HPLC Guard Column PK3
2C184-05G30K	C18G x 5 µm Particle Size x 300 Å Pore Size, 10 mm Length x 300 µm ID, PEEKsil ProteCol HPLC Guard Column PK3
<b>C18H</b>	
2C182-03G15K	C18H x 3 µm Particle Size x 120 Å Pore Size, 10 mm Length x 150 µm ID, PEEKsil ProteCol HPLC Guard Column PK3
2C182-03G30K	C18H x 3 µm Particle Size x 120 Å Pore Size, 10 mm Length x 300 µm ID, PEEKsil ProteCol HPLC Guard Column PK3
2C182-05G15K	C18H x 5 µm Particle Size x 120 Å Pore Size, 10 mm Length x 150 µm ID, PEEKsil ProteCol HPLC Guard Column PK3
2C182-05G30K	C18H x 5 µm Particle Size x 120 Å Pore Size, 10 mm Length x 300 µm ID, PEEKsil ProteCol HPLC Guard Column PK3
<b>C18P</b>	
2POL-03G15K	C18P x 3 µm Particle Size x 120 Å Pore Size, 10 mm Length x 150 µm ID, PEEKsil ProteCol HPLC Guard Column PK3
2POL-05G15K	C18P x 5 µm Particle Size x 120 Å Pore Size, 10 mm Length x 150 µm ID, PEEKsil ProteCol HPLC Guard Column PK3
2POL-03G30K	C18P x 3 µm Particle Size x 120 Å Pore Size, 10 mm Length x 300 µm ID, PEEKsil ProteCol HPLC Guard Column PK3
2POL-05G30K	C18P x 5 µm Particle Size x 120 Å Pore Size, 10 mm Length x 300 µm ID, PEEKsil ProteCol HPLC Guard Column PK3
<b>C18Q</b>	
2C183-03G15K	C18Q x 3 µm Particle Size x 100 Å Pore Size, 10 mm Length x 150 µm ID, PEEKsil ProteCol HPLC Guard Column PK3
2C183-03G30K	C18Q x 3 µm Particle Size x 100 Å Pore Size, 10 mm Length x 300 µm ID, PEEKsil ProteCol HPLC Guard Column PK3
2C183-05G15K	C18Q x 5 µm Particle Size x 100 Å Pore Size, 10 mm Length x 150 µm ID, PEEKsil ProteCol HPLC Guard Column PK3
2C183-05G30K	C18Q x 5 µm Particle Size x 100 Å Pore Size, 10 mm Length x 300 µm ID, PEEKsil ProteCol HPLC Guard Column PK3

For more information about this product visit [www.sge.com](http://www.sge.com) or contact [techsupport@sge.com](mailto:techsupport@sge.com).

## Separations | eVol® MEPS® BINs

Every One an Expert

eVol® XR digital analytical syringe is the coupling of two precision devices: a digitally controlled electronic drive and an XCHANGE® enabled analytical syringe.

eVol® XR syringes are easily and quickly changed allowing them to be dedicated to individual liquids or methods to prevent possible cross-contamination of reagents.

MEPS® is Micro Extraction by Packed Sorbent, the miniaturization of conventional SPE packed bed devices from milliliter bed volumes to microliter volumes. The MEPS approach to sample preparation is suitable for reversed phases, normal phases, mixed mode or ion exchange chemistries.

The MEPS Barrel Insert and Needle (BIN) assembly contains the stationary phase, and is built into the syringe needle.

### Features and Benefits

eVol® MEPS BINs are compatible for use with eVol Syringes.

The eVol® XR custom programming function enables MEPS (micro SPE) to be semi-automated, reducing errors, and improving reproducibility.

### Recommended Applications

SPE method development, and/or proofing before transition to fully automated platforms. Processing small sample batches, or urgent samples.

### Product Specifications

MEPS BINs are available for use with eVol, with C2, C8, C18, Amino-Propyl Silane phases, for LC and GC applications.

MEPS BINs can be used with 50 µL, 100 µL and 500 µL eVol MEPS syringes.

For more information about this product refer to product data sheets PD-1013-G Syringes | eVol XR Kits, PD-1014-G Syringes | eVol XR, PD-1030-G Syringes | MEPS, PD-1013-G, visit [www.sge.com](http://www.sge.com) or contact [techsupport@sge.com](mailto:techsupport@sge.com).

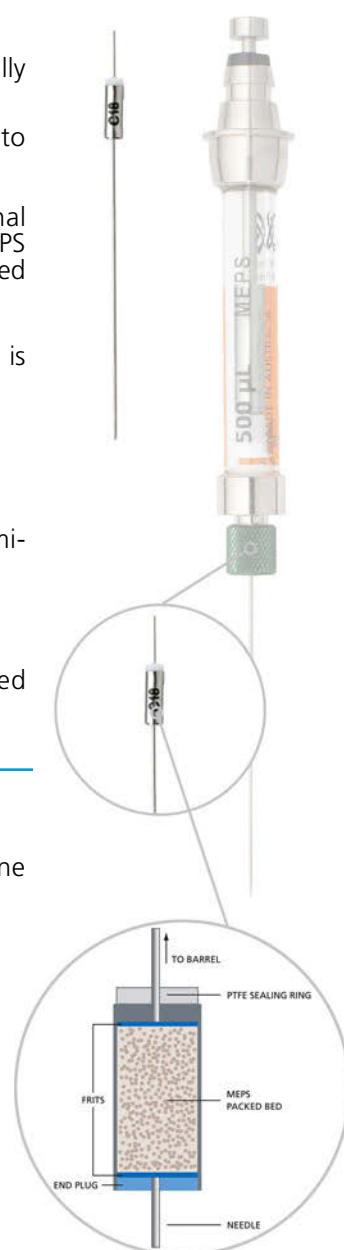



## Separations | eVol<sup>®</sup> MEPS<sup>®</sup> BINs

Every One an Expert

Part Number	Part Description and Detail
<b>MEPS Barrel Insert and Needle (BIN) for GC Applications</b>	
2900711	C18 MEPS BIN for eVol MEPS Syringes, 0.63 mm OD Cone Tipped Needle PK5
2900712	C8 MEPS BIN for eVol MEPS Syringes, 0.63 mm OD Cone Tipped Needle PK5
2900713	APS MEPS BIN for eVol MEPS Syringes, 0.63 mm OD Cone Tipped Needle PK5
2900715	HDVB MEPS BIN for eVol MEPS Syringes, 0.63 mm OD Cone Tipped Needle PK5
2900716	SDVB MEPS BIN for eVol MEPS Syringes, 0.63 mm OD Cone Tipped Needle PK5
2900717	C2 MEPS BIN for eVol MEPS Syringes, 0.63 mm OD Cone Tipped Needle PK5
<b>MEPS Barrel Insert and Needle (BIN) for LC Applications</b>	
2900701	C18 MEPS BIN for eVol MEPS Syringes, 0.72 mm OD LC Tipped Needle PK5
2900702	C8 MEPS BIN for eVol MEPS Syringes, 0.72 mm OD LC Tipped Needle PK5
2900703	APS MEPS BIN for eVol MEPS Syringes, 0.72 mm OD LC Tipped Needle PK5
2900705	HVDB MEPS BIN for eVol MEPS Syringes, 0.72 mm OD LC Tipped Needle PK5
2900706	SDVB MEPS BIN for eVol MEPS Syringes, 0.72 mm OD LC Tipped Needle PK5
2900707	C2 MEPS BIN for eVol MEPS Syringes, 0.72 mm OD LC Tipped Needle PK5

For more information visit [www.sge.com](http://www.sge.com) or contact [techsupport@sge.com](mailto:techsupport@sge.com).

## Separations | MEPS® BINs

### Extraction to Injection in a Single Process

MEPS® is Micro Extraction by Packed Sorbent, the miniaturization of conventional SPE packed bed devices from milliliter bed volumes to microliter volumes. The MEPS approach to sample preparation is suitable for reversed phases, normal phases, mixed mode or ion exchange chemistries.

The MEPS Barrel Insert and Needle (BIN) assembly contains the stationary phase, and is built into the syringe needle. Using MEPS requires both a suitable syringe and a MEPS BIN.

With MEPS, the sample processing, extraction and injection steps are performed using the same syringe.

#### Features and Benefits

- MEPS BINs are compatible for use with MEPS syringes.
- Save hours in sample preparation.
- Semi or fully automate to improve workflow and increase productivity.
- Reduce solvent usage and sample volume.
- Reuseable as the packing material is washed between samples.
- Works with samples as small as 10 µL.

#### Recommended Applications

SPE method development, and/or proofing before transition to fully automated platforms. Processing small sample batches, or urgent samples.

#### Product Specifications

MEPS BINs are available with C2, C8, C18, Silica, and C8+SCX phases, for both LC and GC applications. SCX and SAX phases are also available for LC applications.

MEPS syringes are available separately.

For more information about this product refer to product data sheet PD-1030-G Syringes | MEPS, visit [www.sge.com](http://www.sge.com) or contact [techsupport@sge.com](mailto:techsupport@sge.com).

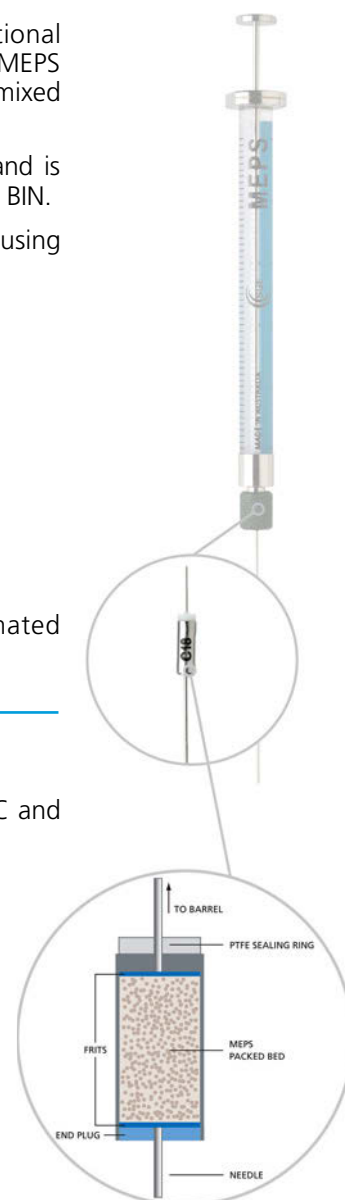

## Separations | MEPS® BINs

### Extraction to Injection in a Single Process

Part Number	Part Description and Detail
<b>MEPS Barrel Insert and Needle (BIN) for GC Applications</b>	
<b>MEPS BINs for CTC &amp; Thermo Systems</b>	
2900101	C18 GC MEPS BIN for CTC & Thermo, 0.63 mm OD Cone Tipped Needle PK5
2900102	Silica GC MEPS BIN for CTC & Thermo, 0.63 mm OD Cone Tipped Needle PK5
2900103	C8 + SCX GC MEPS BIN for CTC & Thermo, 0.63 mm OD Cone Tipped Needle PK5
2900104	C2 GC MEPS BIN for CTC & Thermo, 0.63 mm OD Cone Tipped Needle PK5
2900105	GC MEPS BIN Development Kit (1x each C18, C8, C2, Si, C8+SCX) for CTC & Thermo, 0.63 mm OD Cone Tipped Needle PK5
2900106	C8 GC MEPS BIN for CTC & Thermo, 0.63 mm OD Cone Tipped Needle PK5
<b>MEPS BINs for CTC Systems using 250 µL Syringes</b>	
2900301	C18 GC MEPS BIN for CTC 250 µL Syringes, 0.63 mm OD Cone Tipped Needle PK5
2900302	C18 GC MEPS BIN for CTC 250 µL Syringes, 0.63 mm OD Cone Tipped Needle PK5
2900303	C8 + SCX GC MEPS BIN for CTC 250 µL Syringes, 0.63 mm OD Cone Tipped Needle PK5
2900304	C2 GC MEPS BIN for CTC 250 µL Syringes, 0.63 mm OD Cone Tipped Needle PK5
2900305	GC MEPS BIN Development Kit (1x each C18, C8, C2, Si, C8+SCX) for CTC 250 µL Syringes, 0.63 mm OD Cone Tipped Needle PK5
2900306	C8 GC MEPS BIN for CTC 250 µL Syringes, 0.63 mm OD Cone Tipped Needle PK5
<b>MEPS BINs for Agilent &amp; Shimadzu Systems</b>	
2900601	C18 GC MEPS BIN for Agilent & Shimadzu, 0.63 mm OD Cone Tipped Needle PK5
2900602	Silica GC MEPS BIN for Agilent & Shimadzu, 0.63 mm OD Cone Tipped Needle PK5
2900603	C8 + SCX GC MEPS BIN for Agilent & Shimadzu, 0.63 mm OD Cone Tipped Needle PK5
2900604	C2 GC MEPS BIN for Agilent & Shimadzu, 0.63 mm OD Cone Tipped Needle PK5
2900605	GC MEPS BIN Development Kit (1x each C18, C8, C2, Si, C8+SCX) for Agilent & Shimadzu, 0.63 mm OD Cone Tipped Needle PK5
2900606	C8 GC MEPS BIN for Agilent & Shimadzu, 0.63 mm OD Cone Tipped Needle PK5
2900607	HLB GC MEPS BIN for Agilent & Shimadzu, 0.63 mm OD Cone Tipped Needle PK5
<b>MEPS Barrel Insert and Needle (BIN) for LC Applications</b>	
<b>MEPS BINs for CTC &amp; Thermo Systems</b>	
2900401	C18 LC MEPS BIN for CTC & Thermo, 0.72 mm OD LC Tipped Needle PK5
2900402	Silica LC MEPS BIN for CTC & Thermo, 0.72 mm OD LC Tipped Needle PK5
2900403	C8 + SCX LC MEPS BIN for CTC & Thermo, 0.72 mm OD LC Tipped Needle PK5
2900404	C2 LC MEPS BIN for CTC & Thermo, 0.72 mm OD LC Tipped Needle PK5
2900405	LC MEPS BIN Development Kit (1x each C18, C8, C2, Si, C8+SCX) for CTC & Thermo, 0.72 mm OD LC Tipped Needle PK5
2900406	C8 LC MEPS BIN for CTC & Thermo, 0.72 mm OD LC Tipped Needle PK5
2900408	SCX LC MEPS BIN for CTC & Thermo, 0.72 mm OD LC Tipped Needle PK5
2900409	SAX LC MEPS BIN for CTC & Thermo, 0.72 mm OD LC Tipped Needle PK5
<b>MEPS BINs for CTC Systems using 250 µL Syringes</b>	
2900501	C18 LC MEPS BIN for CTC 250 µL Syringes, 0.72 mm OD LC Tipped Needle PK5
2900502	Silica LC MEPS BIN for CTC 250 µL Syringes, 0.72 mm OD LC Tipped Needle PK5
2900503	C8 + SCX LC MEPS BIN for CTC 250 µL Syringes, 0.72 mm OD LC Tipped Needle PK5
2900504	C2 LC MEPS BIN for CTC 250 µL Syringes, 0.72 mm OD LC Tipped Needle PK5
2900505	LC MEPS BIN Development Kit (1x each C18, C8, C2, Si, C8+SCX) for CTC 250 µL Syringes, 0.72 mm OD LC Tipped Needle PK5
2900506	C8 LC MEPS BIN for CTC 250 µL Syringes, 0.72 mm OD LC Tipped Needle PK5
2900508	SCX LC MEPS BIN for CTC 250 µL Syringes, 0.72 mm OD LC Tipped Needle PK5
2900509	SAX LC MEPS BIN for CTC 250 µL Syringes, 0.72 mm OD LC Tipped Needle PK5

For more information about this product visit [www.sge.com](http://www.sge.com) or contact [techsupport@sge.com](mailto:techsupport@sge.com).



# Connections

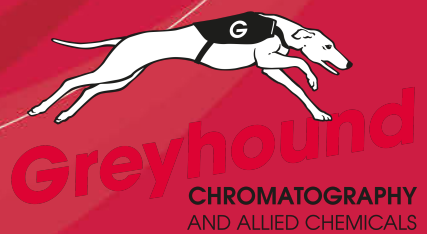

## Connections | GC Ferrules Graphite

Your chromatography analysis does not end with the selection of the GC column. The combination of components selected for your instrument also make an important contribution to successful separations.

The SGE range of GC Connections improves your chromatography. Poorly defined or selected connections can lead to an increase in dead volume, leaks from cycled temperatures and mismatched tubing sizes.



### Features and Benefits









- Easy to use.
- Forms a reliable seal.
- Reusable.
- Soft material, forms a soft grip to the capillary column.
- Low emissions.

### Recommended Applications

Column to injector and column to FID connections. Porous to oxygen, therefore unsuitable for connecting columns to mass spectrometers.

### Product Specifications

- Variety of hole sizes available for 1/16", 1/8", and 1/4" fittings.
- 450 °C temperature limit.
- Variety of profiles available:

	Straight (hole ID matches the nominal size of the fitting)
	Sealing Ring
	Reducing Ferrule (hole ID smaller than the nominal size of fittings)
	Reducing Ferrule - Short
	2-Hole Ferrule
	3-Hole Ferrule
	No-Hole Ferrule - Blank
	No-Hole Ferrule - Short and Blank

For more information about this product visit [www.sge.com](http://www.sge.com) or contact [techsupport@sge.com](mailto:techsupport@sge.com).

## Connections | GC Ferrules Graphite

Part Number	Part Description and Detail
0726001	Graphite Sealing Ring with 5 mm Hole for Shimadzu 14, 15A & 16 (Spl-14 Injector) Liners & 5 mm OD Packed Columns, PK10
072601	Graphite Short Ferrule with 1/4 " Hole for 1/4 " Fittings, Bruker/Varian 1075 & 1077 Injection Port Liners, Unions, & 1/4 " OD Packed Columns, PK10
072602	Graphite Short Ferrule with 1/8 " Hole for 1/8 " Fittings, Unions, & 1/8 " OD Packed Columns, PK10
072603	Graphite Short Ferrule with 1/16 " Hole for 1/16 " Fittings, Unions, PK10
072604	Graphite Short Reducing Ferrule with 6 mm Hole for 1/4 " Fittings, PK10
072605	Graphite Short Ferrule with 5 mm Hole for 5 mm Fittings, PK10
072606	Graphite Short Reducing Ferrule with 1.2 mm Hole for 1/16 " Fittings, PK10
072607	Graphite Short Reducing Ferrule with 1 mm Hole for 1/16 " Fittings, PK10
072608	Graphite Short Reducing Ferrule with 0.8 mm Hole for 1/16 " Fittings, PK10
0726080	Graphite Ferrule with 0.5 mm Hole for GC14A, GC17A, GC2010 and GC2014 Detector / Injectors (Not for MS Interfaces or QP2010 Injector), PK10
0726082	Graphite Ferrule with 0.8 mm Hole for GC14A, GC17A, GC2010 and GC2014 Detector / Injectors (Not for MS Interfaces or QP2010 Injector), PK10
072609	Graphite Short Reducing Ferrule with 1.2 mm Hole for 1/8 " Fittings, PK10
072610	Graphite Short Reducing Ferrule with 0.5 mm Hole for 1/16 " Fittings, PK10
072613	Graphite Short Ferrule with 1/2 " Hole for 1/2 " Fittings, PK10
072614	Graphite Ferrule with 0.8 mm Hole for Carlo Erba Detector / Injectors (Not for GC/MS, Not Suitable for 8000 Series and Trace/Focus GC), PK10
072615	Graphite Short Ferrule with 3/8 " Hole for 3/8 " Fittings, PK10
0726151	Graphite Short Reducing Ferrule with 1/8 " Hole for 1/4 " Fittings, PK10
072617	Graphite Short Reducing Ferrule with 5/16 " Hole for 1/4 " Fittings, PK10
072619	Graphite Ferrule with 0.5 mm Hole for Carlo Erba Detector / Injectors (Not for GC/MS, Not Suitable for 8000 Series and Trace/Focus GC), PK10
072621	Graphite Ferrule with 1/4 " Hole for 1/4 " OD Packed Columns, PK10
0726212	Graphite Reducing Ferrule with 6 mm Hole for 1/4 " Fittings, PK10
0726217	Graphite Sealing Ring for Varian 1078 & 1079 Injectors, PK10
072622	Graphite Ferrule with 1/8 " Hole for 1/8 " OD Packed Columns, PK10
072623	Graphite Ferrule with 1/16 " Hole for 1/16 " Fittings, PK10
072624	Graphite Ferrules with 0.5 mm Hole for Use with 1/8 " Nuts on PerkinElmer Injectors & Detectors, PK10
072625	Graphite Ferrule with 1.0 mm Hole for 1/16 " Fittings, PK10
072626	Graphite Ferrule with 0.8 mm Hole for 1/16 " Fittings, PK10
072627	Graphite Ferrule with 0.5 mm Hole for 1/16 " Fittings, PK10
0726270	Graphite Ferrule with 0.8 mm Hole for 1/8 " Fittings, PK10
072628	Graphite Ferrule with 1.2 mm Hole for 1/8 " Fittings, PK10
0726280	Graphite Ferrules with 1.0 mm Hole for Use with 1/8 " Nuts on PerkinElmer Injectors & Detectors, PK10
0726281	Graphite Ferrule with 1/8 " Hole for 1/4 " Fittings, PK10
0726282	Graphite Ferrule with 1/16 " Hole for 1/4 " Fittings, PK10
0726283	Graphite Ferrule with 1/16 " Hole for 1/8 " Fittings, PK10
0726288	Replacement Ferrule for Obsolete SGE Varian Flame Jet, PK10
072629	Replacement Mini Union Graphite Ferrules with 0.8 mm Hole, PK10
072630	Replacement Mini Union Graphite Ferrules with 0.5 mm Hole, PK10
072635	Graphite Short Reducing Ferrule with 0.5 mm Hole for Detector / Injectors (Not for MSD Interface Connections) , PK10
072636	Graphite Short Reducing Ferrule with 0.8 mm Hole for Detector / Injectors (Not for MSD Interface Connections) , PK10

For more information about this product visit [www.sge.com](http://www.sge.com) or contact [techsupport@sge.com](mailto:techsupport@sge.com).

## Connections | GC Ferrules Graphite Vespel®

Your chromatography analysis does not end with the selection of the GC column. The combination of components selected for your instrument also make an important contribution to successful separations.

The SGE range of GC Connections improves your chromatography. Poorly defined or selected connections can lead to an increase in dead volume, leaks from cycled temperatures and mismatched tubing sizes.



### Features and Benefits









- A composite of graphite and Vespel®.
- Mechanically robust, hard material, long lifetime.
- Forms a strong grip with capillary column.

### Recommended Applications

MS interfaces.

### Product Specifications

- Variety of hole sizes available for 1/16 " , 1/8 " , and 1/4 " fittings.
- 350 °C temperature limit.
- Variety of profiles available:

	Straight (hole ID matches the nominal size of the fitting)
	Sealing Ring
	Reducing Ferrule (hole ID smaller than the nominal size of fittings)
	Reducing Ferrule - Short
	2-Hole Ferrule
	3-Hole Ferrule
	No-Hole Ferrule - Blank
	No-Hole Ferrule - Short and Blank

For more information about this product visit [www.sge.com](http://www.sge.com) or contact [techsupport@sge.com](mailto:techsupport@sge.com).

Vespel is a registered trademark of DuPont™



## Connections | GC Ferrules Graphite Vespel®

Part Number	Part Description and Detail
072671	15% Graphite/85% Vespel Ferrule with 0.8 mm Hole for 1/8 " Fitting, PK10
072673	15% Graphite/85% Vespel Ferrule with 1/8 " Hole for 1/16 " Fitting, PK10
072674	15% Graphite/85% Vespel Ferrule with 2 x 0.8 mm Holes for 1/8 " Fitting, PK10
072694	15% Graphite/85% Vespel Mini Union Ferrule with No Hole, PK10
072695	15% Graphite/85% Vespel Mini Union Ferrule with 0.3 mm Hole, PK10
072696	15% Graphite/85% Vespel Mini Union Ferrule with 0.4 mm Hole, PK10
072697	15% Graphite/85% Vespel Mini Union Ferrule with 0.5 mm Hole, PK10
072698	15% Graphite/85% Vespel Mini Union Ferrule with 0.8 mm Hole, PK10
073105	15% Graphite/85% Vespel Short Ferrule with No Hole, for Agilent Injectors, PK10
073107	15% Graphite/85% Vespel Short Ferrule with 0.3 mm Hole, for Agilent Injectors, PK10
073109	15% Graphite/85% Vespel Short Ferrule with 0.4 mm Hole, for Agilent Injectors, PK10
073111	15% Graphite/85% Vespel Short Ferrule with 0.5 mm Hole, for Agilent Injectors, PK10
073113	15% Graphite/85% Vespel Short Ferrule with 0.8 mm Hole, for Agilent Injectors, PK10
0726547	15% Graphite/85% Vespel Ferrule with 0.8 mm Hole, for Shimadzu QP5000-II & QP5050 Standard MS Interface, PK10
0726548	15% Graphite/85% Vespel Ferrule with 0.7 mm Hole for Carlo Erba Instruments, Not Suitable for 8000 Series and Trace/Focus GC, PK10
0726549	15% Graphite/85% Vespel Ferrule with 0.4 mm Hole for Carlo Erba Instruments, Not Suitable for 8000 Series and Trace/Focus GC, PK10
0726557	15% Graphite/85% Vespel Ferrule with 0.5 mm Hole for Carlo Erba Instruments, Not Suitable for 8000 Series and Trace/Focus GC, PK10
0726560	15% Graphite/85% Vespel Ferrule with 0.3 mm Hole, for Shimadzu QP5000-II & QP5050 Standard MS Interface, PK10
0726561	15% Graphite/85% Vespel Ferrule with 0.4 mm Hole, for Shimadzu QP5000-II & QP5050 Standard MS Interface, PK10
0726562	15% Graphite/85% Vespel Ferrule with 0.5 mm Hole, for Shimadzu QP5000-II & QP5050 Standard MS Interface, PK10
0726563	15% Graphite/85% Vespel Ferrule with 0.4 mm Hole, for Shimadzu QP5000-I Standard MS Interface, PK10
0726564	15% Graphite/85% Vespel Ferrule with 0.5 mm Hole, for Shimadzu QP5000-I Standard MS Interface, PK10
0726591	15% Graphite/85% Vespel Vg/Micromass Ferrule with 0.3/0.4 mm Hole for 1/16 " Fitting, PK10
0726632	15% Graphite/85% Vespel Ferrule with 0.2 mm Hole for 1/16 " Fitting, PK10
0726640	15% Graphite/85% Vespel Ferrule with 1 x 0.5 mm Hole & 1 x 0.3 mm Hole for 1/16 " Fitting, PK10
0726641	15% Graphite/85% Vespel Ferrule with 1 x 0.4 mm Hole & 1 x 0.3 mm Hole for 1/16 " Fitting, PK10
0726642	15% Graphite/85% Vespel Ferrule with 1 x 0.5 mm Hole & 1 x 0.4 mm Hole for 1/16 " Fitting, PK10
0726650	15% Graphite/85% Vespel Ferrule with 3 x 0.3 mm Holes for 1/16 " Fitting, PK10
0726660	15% Graphite/85% Vespel Ferrule with 0.5 mm Hole for 1/4 " Fitting, PK10
0726673	15% Graphite/85% Vespel Ferrule with 6 mm Hole for 1/4 " Fitting, PK10
0726700	15% Graphite/85% Vespel Ferrule with 2.4 mm Hole for 1/8 " Fitting, PK10
0726701	15% Graphite/85% Vespel Ferrule with 1/16 " Hole for 1/8 " Fitting, PK10
0726702	15% Graphite/85% Vespel Ferrule with 0.5 mm Hole for 1/8 " Fitting, PK10
0726703	15% Graphite/85% Vespel Ferrule with 0.4 mm Hole for 1/8 " Fitting, PK10
0726288	Replacement Ferrule for Obsolete SGE Varian Flame Jet, PK10
072629	Replacement Mini Union Graphite Ferrules with 0.8 mm Hole, PK10
072630	Replacement Mini Union Graphite Ferrules with 0.5 mm Hole, PK10
072635	Graphite Short Reducing Ferrule with 0.5 mm Hole for Detector /Injectors (Not for MSD Interface Connections), PK10
072636	Graphite Short Reducing Ferrule with 0.8 mm Hole for Detector /Injectors (Not for MSD Interface Connections), PK10

For more information about this product visit [www.sge.com](http://www.sge.com) or contact [techsupport@sge.com](mailto:techsupport@sge.com).

## Connections | GC Ferrules SilTite®

SilTite® metal ferrules have been developed specifically to overcome the problems associated with the use of 100% graphite and composite ferrules. SilTite ferrules form a strong and permanent airtight seal around the capillary column and have a temperature limit well above the temperature capacity of the injector, MS interface or GC oven. The metal SilTite ferrule together with the metal nut have the same coefficient of thermal expansion. The ferrule and nut expand and contract at the same rate eliminating any chance of annoying leaks. The nut does not need to be re-tightened after initial temperature cycles.



### Features and Benefits

- Strong seal on capillary columns - reduced air background.
- No contamination - cleaner spectra.
- Leak free - nut does not need re-tightening after initial temperature cycles.

### Recommended Applications

MS interfaces.

### Product Specifications

Kits available for Agilent, PerkinElmer, Shimadzu, Thermo Scientific, and Varian/Bruker GC-MS systems.

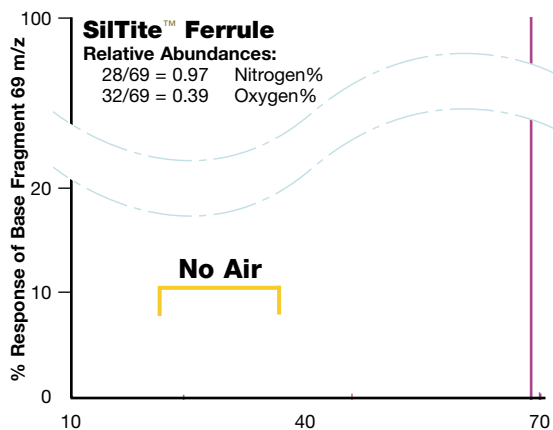

For more information about this product visit [www.sge.com](http://www.sge.com) or contact [techsupport@sge.com](mailto:techsupport@sge.com).

## Connections | GC Ferrules SilTite®

Part Number	Part Description and Detail
073301	SilTite Metal - Initial Installation 0.32 mm ID Columns (10 Ferrules, 2 Nuts)
073302	SilTite Metal - Initial Installation 0.45-0.53 mm ID Columns (10 Ferrules, 2 Nuts)
073231	SilTite Metal Nuts, PK5
<b>For Use on Shimadzu QP5000/5050 Standard MS Interface</b>	
073204	SilTite Metal - Initial Installation for 0.10-0.25 mm ID Columns (10 Ferrules, 2 Nuts)
073205	SilTite Metal - Initial Installation 0.32 mm ID Columns (10 Ferrules, 2 Nuts)
073233	SilTite Metal Nuts - QP5000/5050 Standard MS Interface, PK5
<b>For Use on Shimadzu GC14A, GC17A, GC2010 and GC2014 Detector / Injectors, &amp; QP5000/5050 Standard MS Interface (Not for MS Interfaces or QP2010 Injector)</b>	
073227	SilTite Ferrules for Use with 0.10-0.25 mm ID Columns, PK10
073228	SilTite Ferrules for Use with 0.32 mm ID Columns, PK10
073229	SilTite Ferrules for Use with 0.45-0.53 mm ID Columns, PK10
073350	SilTite Metal - Initial Installation for 0.10-0.25 mm ID Columns (10 Ferrules, 2 Nuts)
073351	SilTite Metal - Initial Installation 0.32 mm ID Columns (10 Ferrules, 2 Nuts)
073352	SilTite Metal - Initial Installation 0.45-0.53 mm ID Columns (10 Ferrules, 2 Nuts)
073232	SilTite Metal Nuts - Slotted, PK5
<b>For Use on Thermo GC/MS Interface Connections</b>	
073330	SilTite Ferrules for Use with 0.10-0.25 mm ID Columns, PK10
073331	SilTite Ferrules for Use with 0.32 mm ID Columns, PK10
073332	SilTite Ferrules for Use with 0.45-0.53 mm ID Columns, PK10
073333	SilTite Ferrules for Use with 1/32 " Columns, PK10
073450	SilTite Metal - Initial Installation for 0.10-0.25 mm ID Columns (10 Ferrules, 2 Nuts)
073451	SilTite Metal - Initial Installation 0.32 mm ID Columns (10 Ferrules, 2 Nuts)
073452	SilTite Metal - Initial Installation 0.45-0.53 mm ID Columns (10 Ferrules, 2 Nuts)
<b>For Use on PerkinElmer MS Interface, Shimadzu QP5000/5050 Wide Bore MS Interface, QP2010 Injector and QP2010 Standard MS Interface, Agilent MS Interface</b>	
073219	SilTite Ferrules for Use with 1/32 " Columns, PK10
073220	SilTite Ferrules for Use with 0.10-0.25 mm ID Columns, PK10
073221	SilTite Ferrules for Use with 0.32 mm ID Columns, PK10
073222	SilTite Ferrules for Use with 0.45-0.53 mm ID Columns, PK10
073223	SilTite Ferrules 1/16 ", PK10
073200	SilTite Metal - Initial Installation for 0.10-0.25 mm ID Columns (10 Ferrules, 2 Nuts)
073201	SilTite Metal - Initial Installation 0.32 mm ID Columns (10 Ferrules, 2 Nuts)
073202	SilTite Metal - Initial Installation 0.45-0.53 mm ID Columns (10 Ferrules, 2 Nuts)
073203	SilTite Metal - Initial Installation 1/16 " (10 Ferrules, 2 Nuts)
073224	SilTite Metal Nuts 10/32 " 0.8 mm ID PK5
073225	SilTite Metal Nuts 10/32 " 1/16 " ID PK5

For more information about this product visit [www.sge.com](http://www.sge.com) or contact [techsupport@sge.com](mailto:techsupport@sge.com).

## Connections | GC Ferrules SilTite® FingerTite

The Smart Alternative. One Nut, One Ferrule, All Systems.

SilTite® FingerTite is a GC ferrule system that has been designed to be installed only with the force of you fingers, delivering an easy, leak and maintenance free seal.

### Features and Benefits

- Simplified installation process saves time.
- Leak free - no column creep.
- Cannot overtighten - no broken columns.
- Chemically inert - no contamination.
- Metal ferrule - no temperature limit.

### Recommended Applications

MS, high throughput laboratories.



---

### Product Specifications

Kits available for Agilent, PerkinElmer, Shimadzu, Thermo Scientific, and Varian/Bruker GC-MS systems.

Ferrules available with 0.4, 0.5, and 0.7 mm hole sizes. Blanking ferrules, replacement female nuts, and replacement Agilent base seals also available.

For more information about this product visit [www.sge.com](http://www.sge.com) or contact [techsupport@sge.com](mailto:techsupport@sge.com).

## Connections | GC Ferrules SilTite® FingerTite

The Smart Alternative. One Nut, One Ferrule, All Systems.

Part Number	Part Description and Detail
073630	SilTite FingerTite Ferrule 0.4 mm Hole
073631	SilTite FingerTite Ferrule 0.5 mm Hole
073632	SilTite FingerTite Ferrule 0.7 mm Hole
073633	SilTite FingerTite Blanking Ferrule
073636	SilTite FingerTite Female Nut
073625	SilTite FingerTite Generic Starter Kit
0736100	SilTite FingerTite Starter Kit (5 x Female Nuts, 10 x 0.4 mm Hole Ferrules, 1 x Measuring Tool)
0736105	SilTite FingerTite Starter Kit (5 x Female Nuts, 10 x 0.5 mm Hole Ferrules, 1 x Measuring Tool)
<b>Agilent</b>	
07361153	SilTite FingerTite Agilent Capillary / FID Starter Kit for Use with 0.53 mm ID Columns
07361154	SilTite FingerTite Agilent Capillary Injector Starter Kit for Use with 0.53 mm ID Columns (10 x 0.7 mm Ferrules)
073611	SilTite FingerTite Agilent Capillary / FID Starter Kit
073610	SilTite FingerTite Agilent INJ / FID Starter Kit
073612	SilTite FingerTite Agilent INJ / MS Starter Kit
07361053	SilTite FingerTite Agilent INJ / FID Starter Kit for Use with 0.53 mm ID Columns
07361054	SilTite FingerTite Agilent Injector Starter Kit for Use with 0.53 mm ID Columns (10 x 0.7 mm Ferrules)
0736101	SilTite FingerTite Agilent Capillary Adaptor
0736103	SilTite FingerTite Agilent FID Adaptor (Includes 2 Graphite Vespel FID Ferrules)
0736104	SilTite FingerTite Agilent Injector Adaptor (Includes 2 Base Seals) Also Suits Thermo 1300 Injector
0736102	SilTite FingerTite Agilent MS Adaptor
073640	SilTite FingerTite Agilent MS Adaptor
07364053	SilTite FingerTite Agilent INJ Base Seal for Use with 0.53 mm ID Columns
<b>ATAS</b>	
073650	SilTite FingerTite ATAS OPTIC INJ Adaptor
073651	SilTite FingerTite ATAS OPTIC INJ Starter Kit
<b>Bruker/Varian</b>	
073618	SilTite FingerTite Bruker/Varian INJ / FID Starter Kit
07361853	SilTite FingerTite Bruker/Varian INJ / FID Starter Kit for Use with 0.53 mm ID Columns
073617	SilTite FingerTite Bruker/Varian INJ / MS Starter Kit for Saturn / 1200 GC-MS Systems
073619	SilTite FingerTite Bruker/Varian INJ / MS Starter Kit (Not for 220, 1200, 2000, or 4000 MS Systems)
07361854	SilTite FingerTite Bruker/Varian Injector Starter Kit for Use with 0.53 mm ID Columns (10 x 0.7 mm Ferrules)
<b>Shimadzu</b>	
073628	SilTite FingerTite Shimadzu 17A INJ / FID Starter Kit
07362853	SilTite FingerTite Shimadzu 17A INJ / FID Starter Kit for Use with 0.53 mm ID Columns
07362854	SilTite FingerTite Shimadzu 17A Injector Starter Kit for Use with 0.53 mm ID Columns (10 x 0.7 mm Ferrules)
073629	SilTite FingerTite Shimadzu 17A INJ / MS Starter Kit
073620	SilTite FingerTite Shimadzu 2010 INJ / FID Starter Kit
07362053	SilTite FingerTite Shimadzu 2010 INJ / FID Starter Kit for Use with 0.53 mm ID Columns
073621	SilTite FingerTite Shimadzu 2010 INJ / MS Starter Kit
07362054	SilTite FingerTite Shimadzu 2010 Injector Starter Kit for Use with 0.53 mm ID Columns (10 x 0.7 mm Ferrules)
<b>Thermo</b>	
073616	SilTite FingerTite Thermo INJ (Not for 1300 Injector) / DSQ/DSQII Starter Kit
073614	SilTite FingerTite Thermo INJ (Not for 1300 Injector) / FID Starter Kit
07361453	SilTite FingerTite Thermo INJ (Not for 1300 Injector) / FID Starter Kit for Use with 0.53 mm ID Columns
073615	SilTite FingerTite Thermo INJ (Not for 1300 Injector) / ISQ Starter Kit
07361454	SilTite FingerTite Thermo Injector (Not for 1300 Injector) Starter Kit for Use with 0.53 mm ID Columns
<b>PerkinElmer</b>	
073622	SilTite FingerTite PerkinElmer INJ / FID Starter Kit
073623	SilTite FingerTite PerkinElmer INJ / MS Starter Kit
07362253	SilTite FingerTite PerkinElmer INJ / FID Starter Kit for Use with 0.53 mm ID Columns
07362254	SilTite FingerTite PerkinElmer Injector Starter Kit for Use with 0.53 mm ID Columns (10 x 0.7 mm Ferrules)

## Connections | SilTite® $\mu$ -Unions

### Making Joining Matter

Your chromatography analysis does not end with the selection of the GC column. The combination of components selected for your instrument also make an important contribution to successful separations.

The SGE range of GC Connections improves your chromatography. Poorly defined or selected connections can lead to an increase in dead volume, leaks from cycled temperatures and mismatched tubing sizes.

SilTite®  $\mu$ -Unions are specifically designed and precision engineered for use in capillary GC.



### Features and Benefits

- Inert - Enabled by SGE's expertise in surface chemistry, features chemically deactivated stainless steel ferrules alleviating active sites.
- Zero dead volume - Giving you optimized peak shapes.
- Robust - Stable for both extreme temperature and pressure cycling.
- FingerTite technology - Ensures it's easy to install and leak free.
- SilTite ferrules - No more leaks and no need to re-tighten after installation.
- Only 9 mm in total length and a mass of <0.5 g - Low thermal mass.

### Recommended Applications

- Fitting a pre-column.
- GC x GC connections.

### Product Specifications

Packs contain 2 unions, 5 double taper ferrules, and the necessary tools

Column 1 ID (mm)	Column 2 ID (mm)
0.1 - 0.25	0.1 - 0.25
0.1 - 0.25	0.32
0.1 - 0.25	0.53
0.32	0.32
0.32	0.53
0.53	0.53

### Replacement Parts

#### Replacement SilTite $\mu$ -Union Ferrules

Column 1 ID (mm)	Column 2 ID (mm)	Pack Size
0.1 - 0.25	0.1 - 0.25	10
0.1 - 0.25	0.32	10
0.1 - 0.25	0.53	10
0.32	0.32	10
0.32	0.53	10
0.53	0.53	10

#### Replacement SilTite $\mu$ -Union Only (no ferrules)

Column 1 ID (mm)	Column 2 ID (mm)	Pack Size
0.1 - 0.32	0.1 - 0.32	5
0.1 - 0.32	0.1 - 0.53	5
0.53	0.53	5

For more information about this product visit [www.sge.com](http://www.sge.com) or contact [techsupport@sge.com](mailto:techsupport@sge.com).

## Connections | GC SilTite® $\mu$ -Unions

### Making Joining Matter

Part Number	Part Description and Detail
073560	SilTite $\mu$ -Union for Joining 0.1 - 0.25 mm & 0.1 - 0.25 mm Columns/Fused Silica
073561	SilTite $\mu$ -Union for Joining 0.1 - 0.25 mm & 0.32 mm Columns/Fused Silica
073562	SilTite $\mu$ -Union for Joining 0.1 - 0.25 mm & 0.53 mm Columns/Fused Silica
073563	SilTite $\mu$ -Union for Joining 0.32 mm & 0.32 mm Columns/Fused Silica
073564	SilTite $\mu$ -Union for Joining 0.32 mm & 0.53 mm Columns/Fused Silica
073565	SilTite $\mu$ -Union for Joining 0.53 mm & 0.53 mm Columns/Fused Silica
<b>Replacement Parts</b>	
073566	Replacement SilTite $\mu$ -Union Ferrules for Joining 0.1 - 0.25 mm & 0.1 - 0.25 mm Columns/Fused Silica, PK10
073567	Replacement SilTite $\mu$ -Union Ferrules for Joining 0.1 - 0.25 mm & 0.32 mm Columns/Fused Silica, PK10
073568	Replacement SilTite $\mu$ -Union Ferrules for Joining 0.1 - 0.25 mm & 0.53 mm Columns/Fused Silica, PK10
073572	Replacement SilTite $\mu$ -Union Only (No Ferrules) for Joining 0.1 - 0.32 mm & 0.1 - 0.32 mm Columns/Fused Silica, PK5
073573	Replacement SilTite $\mu$ -Union Only (No Ferrules) for Joining 0.1 - 0.32 mm & 0.53 mm Columns/Fused Silica, PK5
073569	Replacement SilTite $\mu$ -Union Ferrules for Joining 0.32 mm & 0.32 mm Columns/Fused Silica, PK10
073570	Replacement SilTite $\mu$ -Union Ferrules for Joining 0.32 mm & 0.53 mm Columns/Fused Silica, PK10
073571	Replacement SilTite $\mu$ -Union Ferrules for Joining 0.53 mm & 0.53 mm Columns/Fused Silica, PK10
073574	Replacement SilTite $\mu$ -Union Only (No Ferrules) for Joining 0.53 mm & 0.53 mm Columns/Fused Silica, PK5

For more information about this product visit [www.sge.com](http://www.sge.com) or contact [techsupport@sge.com](mailto:techsupport@sge.com).

## Connections | GC Nuts for SGE Fittings

The design of the nuts and fittings are unique in that the fitting is flat faced and the point of the ferrule is towards the nut. This makes the system more robust since the angled portion of the fitting cannot be damaged. For more information, please refer to the Connections | GC Unions Product Data Sheet PD-1081-G.

### Features and Benefits

SGE nuts are made in a variety of:

- Materials - stainless steel, nickel plated brass and brass.
- Lengths - standard (uses short ferrules) and extended (uses standard length ferrules).
- Tubing size - 1/16", 1/8" and 1/4" and mini-union.
- Hole sizes - regular or 1.2 mm for capillary columns.
- Configurations to compliment the SGE ferrule product range - regular, SilTite® range.



**Standard  
Stainless Steel Nut**  
*Uses reducing ferrule -  
short or graphite ring*



**Extended  
Stainless Steel Nut**

### Product Specifications

Description	Use with Tubing OD Sizes
GC Nut Standard Stainless Steel, uses short ferrules	1/8"
GC Nut Standard Stainless Steel, uses short ferrules	1/16"
GC Nut Extended Stainless Steel, uses standard length ferrules	1/16"
GC Nut Extended Stainless Steel, uses standard length ferrules	up to 1.2 mm
GC Nut Extended Brass, uses standard length ferrules	up to 1.2 mm
Stainless Steel Male Nut	1/16"
SilTite FingerTite Female Nut	Fused silica tubing
Nut Mini-nut for mini-unions from SGE	up to 0.68 mm

For more information about this product visit [www.sge.com](http://www.sge.com) or contact [techsupport@sge.com](mailto:techsupport@sge.com).



## Connections | GC Nuts for SGE Fittings

Part Number	Part Description and Detail
<b>Stainless Steel</b>	
103403	1/16 " Hole Stainless Steel, PK5
103408	1/16 " Hole (Extended) Stainless Steel, PK5
1034030	1/16 " Hole Male Stainless Steel Nuts, PK5
103405	1/16 " Fittings x 1.2 mm Hole (Extended) Stainless Steel, PK5
103402	1/8 " Hole Stainless Steel, PK5
1034050	1/8 " Hole (Extended) Stainless Steel, PK5
103407	1/4 " Hole (Extended) Stainless Steel, PK5
103400	1.2 mm Hole Mini Union Stainless Steel Nut, PK5
<b>Brass (Nickel Plated)</b>	
1034085	1/16 " x 1.2 mm Hole (Extended Mini) Brass (Nickel Plated), PK2
103406	1/16 " x 1.2 mm Hole (Extended) Brass (Nickel Plated), PK5
103404	1/16 " Hole Brass (Nickel Plated), PK5
<b>SilTite Metal Nuts</b>	
073224	SilTite Metal Nuts, Female Thread 10-32 ID Hole, PK5
073226	SilTite Metal Nuts for Agilent Split / Splitless Injectors, PK5
073225	SilTite Metal Nuts 10/32 " Female Thread 1/16 " ID Hole, PK5
073232	SilTite Metal Nuts - Slotted Female Thread M5 For Use on Shimadzu GC14A, GC17A, GC2010 and GC2014 Detector / Injectors, (Not For MS Interfaces or QP2010 Injector), PK5
073233	SilTite Metal Nuts - Shimadzu QP5000/5050 Standard MS Interface, PK5
073230	SilTite Metal Nuts For Thermo GC/MS Interface Connections, PK5
073231	SilTite Metal Nuts with 1/4-28 Female Thread For Varian/Bruker GC/MS Interface Connections, PK5
<b>SilTite FingerTite</b>	
073636	SilTite FingerTite Female Nut, PK5

For more information about this product visit [www.sge.com](http://www.sge.com) or contact [techsupport@sge.com](mailto:techsupport@sge.com).







## Connections | GC Unions

### Making Joining Matter

SGE Unions are available in two material types: stainless steel and Glass Lined Tubing (GLT™ lined unions).

- Stainless steel unions come in a variety of tube sizes and configurations for example: straight through, reducing, tees, crosses and bulkheads.
- GLT unions are inert and mainly used for connecting fused silica tubing of various internal diameters.

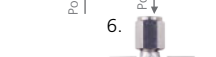
All SGE unions are supplied with the appropriate nuts, ferrules and/or sealing rings.

Union Types	1. Straight Through Unions. 2. Bulkhead Unions.	3. Reducing Unions. 4. Reducing Bulkhead Unions.	5. Union Tees. 6. Union Cross.	7. Glass Lined Mini Unions.	8. SilTite® Mini Unions.
Images	<p>1. </p> <p>2. </p>	<p>3. </p> <p>4. </p>	<p>5. </p> <p>6. </p>	<p>7. </p>	<p>8. </p>
Material Characteristics	<ul style="list-style-type: none"> <li>• Available in Stainless steel or Glass lined (GLT) Stainless steel.</li> </ul>	<ul style="list-style-type: none"> <li>• Stainless steel.</li> </ul>	<ul style="list-style-type: none"> <li>• Stainless steel.</li> </ul>	<ul style="list-style-type: none"> <li>• Glass Lined (GLT) Stainless Steel.</li> </ul>	<ul style="list-style-type: none"> <li>• Glass Lined (GLT) Stainless Steel.</li> <li>• SilTite® Mini Union utilize the SilTite technology – coupling SilTite ferrules with SilTite nuts.</li> </ul>
Connections Suitable	<ul style="list-style-type: none"> <li>• Connecting tubing of the same diameter.</li> <li>• Glass lined tubing (GLT) and plastic tubing.</li> </ul>	<ul style="list-style-type: none"> <li>• For connecting tubing of different diameters.</li> <li>• Suitable for glass lined tubing (GLT), metal and plastic tubing.</li> </ul>	<ul style="list-style-type: none"> <li>• Union tees have the ability to have different size legs for different size tubing.</li> </ul>	<ul style="list-style-type: none"> <li>• Connecting fused silica and capillary tubing.</li> <li>• Tubing of different sizes can also be connected. However, mini union ferrules for the tubing that is different than the normal usage need to be purchased separately.</li> </ul>	<ul style="list-style-type: none"> <li>• Recommended as the best option for attaching fused silica tubing in the laboratory.</li> <li>• Please note that standard Mini Union nuts cannot be used with SilTite ferrules.</li> </ul>
Features, Benefits and Applications	<ul style="list-style-type: none"> <li>• Low dead volume.</li> <li>• Non-swaging, easy to remove fittings that will not deform tubing.</li> <li>• High temperature operations - ferrules are the temperature limiting component.</li> </ul>	<ul style="list-style-type: none"> <li>• Non-swaging, easy to remove fittings that will not deform tubing.</li> <li>• No back ferrule required.</li> <li>• Gives greater flexibility with regards to micro-control valves.</li> <li>• Suitable for glass lined (GLT), metal and plastic tubing.</li> </ul>	<ul style="list-style-type: none"> <li>• Allows splitting of the flow between two or more outlets.</li> <li>• Suitable for glass lined (GLT), metal and plastic tubing.</li> <li>• Non-swaging, easy to remove fittings that will not deform tubing.</li> <li>• No back ferrule required.</li> <li>• The male/female tees can be stacked in order to make a manifold of 1/16" tubing which can be used for drying samples or splitting sample stream to multiple outlets.</li> </ul>	<ul style="list-style-type: none"> <li>• Inert due to glass lining.</li> <li>• Smaller in size than standard 1/16" unions, less of a heat sink and do not put extra weight on fused silica tubing connections.</li> <li>• Fused silica connections due to the reduced weight and thermal mass.</li> </ul>	<ul style="list-style-type: none"> <li>• Allows for tubing to be connected without concern of leakage from temperature cycling or fear of getting pieces of the ferrule stuck inside the tubing.</li> </ul>
Sizes available	<ul style="list-style-type: none"> <li>• 1/16" to 1/4".</li> </ul>	<ul style="list-style-type: none"> <li>• 1/16" to 1/8", 1/16" to 1/4".</li> </ul>	<ul style="list-style-type: none"> <li>• SGE produces four different Tee configurations:               <ol style="list-style-type: none"> <li>1) all 1/16"</li> <li>2) 1 leg 1/8" and two legs 1/16"</li> <li>3) 1 leg 1/4" and two legs 1/16"</li> </ol>               The union cross is a four port union all set up to connect 1/16" tubing.             </li> </ul>	<ul style="list-style-type: none"> <li>• 0.4 mm ID (for use with tubing &lt;0.25 mm ID).</li> <li>• 0.5 mm ID (for use with tubing 0.32 mm ID).</li> <li>• 0.8 mm ID (for use with tubing 0.45 and 0.53 mm ID).</li> </ul>	<ul style="list-style-type: none"> <li>• 0.4 mm ID (for use with tubing &lt; 0.25 mm ID).</li> <li>• 0.5 mm ID (for use with tubing 0.32 mm ID).</li> <li>• 0.8 mm ID (for use with tubing 0.45 and 0.53 mm ID).</li> <li>• 1/32".</li> </ul>

For more information about this product visit [www.sge.com](http://www.sge.com) or contact [techsupport@sge.com](mailto:techsupport@sge.com).

## Connections | GC Unions

### Making Joining Matter

Part Number	Part Description and Detail
18500002	Spanner 3/16 " x 1/4 " AF
<b>Glass Lined Stainless Steel</b>	
103420	Glass Lined Stainless Steel Union with 0.5 mm ID
1034200	Glass Lined Stainless Steel Union with 0.8 mm ID
1236300	Glass Lined Stainless Steel Bulkhead Union with 0.5 mm ID and 0.35 mm Restriction at One End
1236302	Glass Lined Stainless Steel Bulkhead Union with 0.4 mm ID and 0.25 mm Restriction at One End
1236306	Glass Lined Stainless Steel Bulkhead Union with 0.8 mm ID (No Restriction)
<b>Stainless Steel Mini Unions</b>	
103430	Stainless Steel Mini Unions 0.3 mm ID
103431	Stainless Steel Mini Unions 0.4 mm ID
103432	Stainless Steel Mini Unions 0.5 mm ID
103433	Stainless Steel Mini Unions 0.8 mm ID
<b>Stainless Steel</b>	
103330	Stainless Steel Union - 1/16 " x 1/16 "
103418	Stainless Steel Union Tee 1/16 " x 1/16 " x 1/16 "
1034180	Stainless Steel Union Tee 1/8 " x 1/16 " x 1/16 "
1034183	Stainless Steel Union Tee 1/4 " x 1/16 " x 1/16 "
101270	Stainless Steel Union - 1/4 " x 1/4 "
1034187	Stainless Steel Union Cross - All 1/16 "
101340	Stainless Steel Bulkhead Union - 1/16 " x 1/16 "
101290	Stainless Steel Reducing Union - 1/8 " to 1/16 "
101300	Stainless Steel Reducing Bulkhead Union - 1/8 " x 1/16 "
101230	Stainless Steel Reducing Union - 1/4 " to 1/16 "
1034604	Stainless Steel 1/16 " Male-Female Connector and Ferrules
1034605	Stainless Steel 1/16 " Male-Female Tee Connector and Ferrules
103461	Stainless Steel Adaptor for 1/16 " Female Swagelok® Fittings
<b>SilTite</b>	
073550	SilTite Mini Union 0.4 mm ID
073551	SilTite Mini Union 0.5 mm ID
073552	SilTite Mini Union 0.8 mm ID
073553	SilTite Nuts for All Mini Unions, PK5
073554	SilTite Mini Union 0.8 mm ID with Ferrules for 1/32 " Columns
073560	SilTite $\mu$ -Union for Joining 0.1 - 0.25 mm & 0.1 - 0.25 mm Columns/Fused Silica
073561	SilTite $\mu$ -Union for Joining 0.1 - 0.25 mm & 0.32 mm Columns/Fused Silica
073562	SilTite $\mu$ -Union for Joining 0.1 - 0.25 mm & 0.53 mm Columns/Fused Silica
073563	SilTite $\mu$ -Union for Joining 0.32 mm & 0.32 mm Columns/Fused Silica
073564	SilTite $\mu$ -Union for Joining 0.32 mm & 0.53 mm Columns/Fused Silica
073565	SilTite $\mu$ -Union for Joining 0.53 mm & 0.53 mm Columns/Fused Silica
<b>Replacement Parts</b>	
073470	Replacement SilTite Mini Union Ferrules for 0.1 - 0.25 mm ID Columns/Fused Silica, PK10
073471	Replacement SilTite Mini Union Ferrules for 0.32 mm ID Columns/Fused Silica, PK10
073472	Replacement SilTite Mini Union Ferrules for 0.45 - 0.53 mm ID Columns/Fused Silica, PK10
073473	Replacement SilTite Mini Union Ferrules for for 1/32 " Columns, PK11
073566	Replacement SilTite $\mu$ -Union Ferrules for Joining 0.1 - 0.25 mm & 0.1 - 0.25 mm Columns/Fused Silica, PK10
073567	Replacement SilTite $\mu$ -Union Ferrules for Joining 0.1 - 0.25 mm & 0.32 mm Columns/Fused Silica, PK10
073568	Replacement SilTite $\mu$ -Union Ferrules for Joining 0.1 - 0.25 mm & 0.53 mm Columns/Fused Silica, PK10
073572	Replacement SilTite $\mu$ -Union Only (No Ferrules) for Joining 0.1 - 0.32 mm & 0.1 - 0.32 mm Columns/Fused Silica, PK5
073573	Replacement SilTite $\mu$ -Union Only (No Ferrules) for Joining 0.1 - 0.32 mm & 0.53 mm Columns/Fused Silica, PK5
073569	Replacement SilTite $\mu$ -Union Ferrules for Joining 0.32 mm & 0.32 mm Columns/Fused Silica, PK10
073570	Replacement SilTite $\mu$ -Union Ferrules for Joining 0.32 mm & 0.53 mm Columns/Fused Silica, PK10
073571	Replacement SilTite $\mu$ -Union Ferrules for Joining 0.53 mm & 0.53 mm Columns/Fused Silica, PK10

For more information about this product visit [www.sge.com](http://www.sge.com) or contact [techsupport@sge.com](mailto:techsupport@sge.com).

## Connections | GC 3 Port Splitter SilFlow®

### Improve Your GC Connectivity

SGE's SilFlow® delivers a flexible chromatography solution using planar microchannel technology. SilFlow is an innovation in design and fabrication resulting in a highly efficient and reliable micro fluidic platform that improves your GC connectivity to enable maximum chromatography performance.

#### Features and Benefits

- Chemically inert.
- Low dead volume.
- Superb operational stability.
- Easy to install.
- Leak free.

#### Recommended Applications

- Column splitting.
- Detector splitting.
- Backflush.
- Anywhere a tee-piece has traditionally been used.

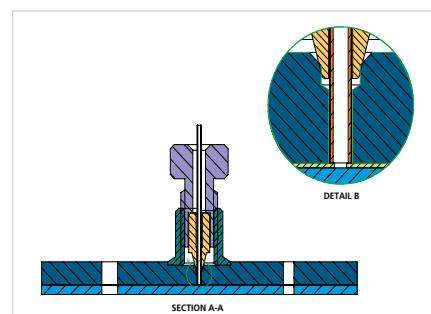

Fused silica to SilFlow connection system using SilTite® FingerTite metal ferrule.

#### Product Specifications

Description	Tubing Dimensions				Pack Size
	Port A	Port B	Port C	Port D	
GC Kit (1.1)	1.1 mm OD	0.25/0.32 mm ID	0.25/0.32 mm ID	–	Kit
GC Kit (0.53)	0.53 mm ID	0.25/0.32 mm ID	0.25/0.32 mm ID	–	Kit
GC Kit (0.25/0.32)	0.25/0.32 mm ID	0.25/0.32 mm ID	0.25/0.32 mm ID	–	Kit
GC MCD (1.1)	1.1 mm OD	0.25/0.32 mm ID	0.25/0.32 mm ID	–	1
GC MCD (0.53)	0.53 mm ID	0.25/0.32 mm ID	0.25/0.32 mm ID	–	1
GC MCD (0.25/0.32)	0.25/0.32 mm ID	0.25/0.32 mm ID	0.25/0.32 mm ID	–	1

#### SilFlow Replacement Parts

Description	Tubing Dimensions	Pack Size
SilFlow Ferrules 1.1 mm ID	For use with tubing of OD 1.07 mm	5
SilFlow Ferrules 0.35 mm ID	For use with tubing of OD 0.32 mm	10
SilFlow Ferrules 0.4 mm ID	For use with tubing of OD 0.36 mm	10
SilFlow Ferrules 0.5 mm ID	For use with tubing of OD 0.45 mm	10
SilFlow Ferrules 0.7 mm ID	For use with tubing of OD 0.68 mm	10
SilFlow Ferrules 0.8 mm ID	For use with tubing of OD 0.79 mm	10
SilFlow Nuts	–	10
SilFlow Blanking Pins	–	5
SilTite FingerTite Tool	–	1

For more information about this product visit [www.sge.com](http://www.sge.com) or contact [techsupport@sge.com](mailto:techsupport@sge.com).

## Connections | GC 3 Port Splitter SilFlow®

Improve Your GC Connectivity

Part Number	Part Description and Detail
123722	Port A 0.25/0.32 mm OD, Ports B & C 0.25/0.32 mm ID SilFlow GC 3 Port Splitter Kit
123721	Port A 0.53 mm OD, Ports B & C 0.25/0.32 mm ID SilFlow GC 3 Port Splitter Kit
123720	Port A 1.1 mm OD, Ports B & C 0.25/0.32 mm ID SilFlow GC 3 Port Splitter Kit
123725	Microchannel Device Only, Port A 0.25/0.32 mm OD, Ports B & C 0.25/0.32 mm ID SilFlow GC 3 Port Splitter Kit
123724	Microchannel Device Only, Port A 0.53 mm OD, Ports B & C 0.25/0.32 mm ID SilFlow GC 3 Port Splitter Kit
123723	Microchannel Device Only, Port A 1.1 mm OD, Ports B & C 0.25/0.32 mm ID SilFlow GC 3 Port Splitter Kit
<b>Replacement Parts</b>	
123704	SilFlow Nuts, PK10
123713	SilFlow Ferrules 0.35 mm ID, PK10
123706	SilFlow Ferrules 0.4 mm ID, PK10
123707	SilFlow Ferrules 0.5 mm ID, PK10
123709	SilFlow Ferrules 0.7 mm ID, PK10
123705	SilFlow Ferrules 1.1 mm ID, PK5
123715	SilFlow Blanking Ferrules and Pins, PK5
123717	SilTite FingerTite Tool
123743	SilFlow Ferrules 0.55 mm ID, PK10
123744	SilFlow Ferrules 0.75 mm ID, PK10
123742	SilFlow Ferrules 0.8 mm ID, PK10
123755	SilFlow Stainless Steel Capillary Tubing, 75 cm Long, 1.1 mm OD Sleeved to 1/16 " at One End (Not Included in Kits, Must Be Purchased Separately If Required)

For more information about this product visit [www.sge.com](http://www.sge.com) or contact [techsupport@sge.com](mailto:techsupport@sge.com).

## Connections | GC 4 Port Splitter SilFlow®

### Improve Your GC Connectivity

SGE's SilFlow® delivers a flexible chromatography solution using planar microchannel technology. SilFlow is an innovation in design and fabrication resulting in a highly efficient and reliable micro fluidic platform that improves your GC connectivity to enable maximum chromatography performance.

#### Features and Benefits

- Chemically inert.
- Low dead volume.
- Superb operational stability.
- Easy to install.
- Leak free.

#### Recommended Applications

- Backflushing.
- Flexibility on column splitting.
- Detector splitting.
- Acts as a three port by blocking off one port.

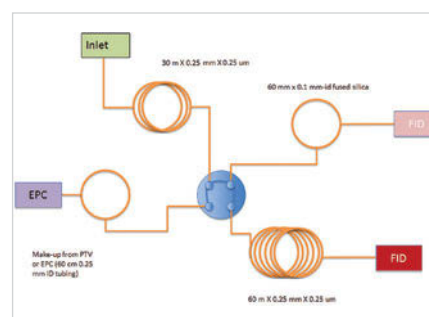

Configuration for backflushing using 4 Port SilFlow™ to FID.

#### Product Specifications

Description	Tubing Dimensions				Pack Size
	Port A	Port B	Port C	Port D	
GC Kit (1.1)	1.1 mm OD	0.25/0.32 mm ID	0.25/0.32 mm ID	0.25/0.32 mm ID	Kit
GC Kit (0.53)	0.53 mm ID	0.25/0.32 mm ID	0.25/0.32 mm ID	0.25/0.32 mm ID	Kit
GC Kit (0.25/0.32)	0.25/0.32 mm ID	0.25/0.32 mm ID	0.25/0.32 mm ID	0.25/0.32 mm ID	Kit
GC MCD (1.1)	1.1 mm OD	0.25/0.32 mm ID	0.25/0.32 mm ID	0.25/0.32 mm ID	1
GC MCD (0.53)	0.53 mm ID	0.25/0.32 mm ID	0.25/0.32 mm ID	0.25/0.32 mm ID	1
GC MCD (0.25/0.32)	0.25/0.32 mm ID	0.25/0.32 mm ID	0.25/0.32 mm ID	0.25/0.32 mm ID	1

#### SilFlow Replacement Parts

Description	Tubing Dimensions	Pack Size
SilFlow Ferrules 1.1 mm ID	For use with tubing of OD 1.07 mm	5
SilFlow Ferrules 0.35 mm ID	For use with tubing of OD 0.32 mm	10
SilFlow Ferrules 0.4 mm ID	For use with tubing of OD 0.36 mm	10
SilFlow Ferrules 0.5 mm ID	For use with tubing of OD 0.45 mm	10
SilFlow Ferrules 0.7 mm ID	For use with tubing of OD 0.68 mm	10
SilFlow Ferrules 0.8 mm ID	For use with tubing of OD 0.79 mm	10
SilFlow Nuts	–	10
SilFlow Blanking Pins	–	5
SilTite FingerTite Tool	–	1

For more information about this product visit [www.sge.com](http://www.sge.com) or contact [techsupport@sge.com](mailto:techsupport@sge.com).

## Connections | GC 4 Port Splitter SilFlow®

Improve Your GC Connectivity

Part Number	Part Description and Detail
123732	Port A 0.25/0.32 mm OD, Ports B, C, & D 0.25/0.32 mm ID SilFlow GC 4 Port Splitter Kit
123731	Port A 0.53 mm OD, Ports B, C, & D 0.25/0.32 mm ID SilFlow GC 4 Port Splitter Kit
123730	Port A 1.1 mm OD, Ports B, C, & D 0.25/0.32 mm ID SilFlow GC 4 Port Splitter Kit
123735	Microchannel Device Only, Ports A 0.25/0.32 mm OD, Port B, C, & D 0.25/0.32 mm ID SilFlow GC 4 Port Splitter Kit
123734	Microchannel Device Only, Ports A 0.53 mm OD, Port B, C, & D 0.25/0.32 mm ID SilFlow GC 4 Port Splitter Kit
123733	Microchannel Device Only, Ports A 1.1 mm OD, Port B, C, & D 0.25/0.32 mm ID SilFlow GC 4 Port Splitter Kit
<b>Replacement Parts</b>	
123704	SilFlow Nuts, PK10
123713	SilFlow Ferrules 0.35 mm ID, PK10
123706	SilFlow Ferrules 0.4 mm ID, PK10
123707	SilFlow Ferrules 0.5 mm ID, PK10
123709	SilFlow Ferrules 0.7 mm ID, PK10
123705	SilFlow Ferrules 1.1 mm ID, PK5
123715	SilFlow Blanking Ferrules and Pins, PK5
123717	SilTite Fingertite Tool
123743	SilFlow Ferrules 0.55 mm ID, PK10
123744	SilFlow Ferrules 0.75 mm ID, PK10
123742	SilFlow Ferrules 0.8 mm ID, PK10
123755	SilFlow Stainless Steel Capillary Tubing, 75 cm Long, 1.1 mm OD Sleeved to 1/16 " at One End (Not Included in Kits, Must Be Purchased Separately If Required)

For more information about this product visit [www.sge.com](http://www.sge.com) or contact [techsupport@sge.com](mailto:techsupport@sge.com).

## Connections | GC Deans' Switch SilFlow®

### Improve Your GC Connectivity

SGE's SilFlow® delivers a flexible chromatography solution using planar microchannel technology. SilFlow is an innovation in design and fabrication resulting in a highly efficient and reliable micro fluidic platform that improves your GC connectivity to enable maximum chromatography performance.

#### Features and Benefits

- Chemically inert.
- Low dead volume.
- Superb operational stability.
- Easy to install.
- Leak free.

#### Recommended Applications

- Heart cutting.
- Deans' switching.
- Column switching.
- Multidimensional GC.

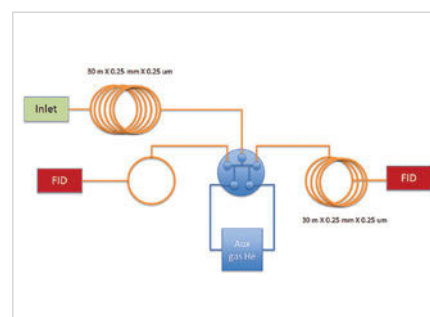

Configuration for heart cutting using Deans' Switch SilFlow™ to dual FID.

#### Product Specifications

Description	Column 1	Column 2	Detector	SW1	SW2	Pack Size
GC Kit	0.25/0.32 mm ID	0.25/0.32 mm ID	0.25/0.32 mm ID	1.1 mm OD	1.1 mm OD	Kit
GC MCD	0.25/0.32 mm ID	0.25/0.32 mm ID	0.25/0.32 mm ID	1.1 mm OD	1.1 mm OD	1

#### SilFlow Replacement Parts

Description	Tubing Dimensions	Pack Size
SilFlow Ferrules 1.1 mm ID	For use with tubing of OD 1.07 mm	5
SilFlow Ferrules 0.35 mm ID	For use with tubing of OD 0.32 mm	10
SilFlow Ferrules 0.4 mm ID	For use with tubing of OD 0.36 mm	10
SilFlow Ferrules 0.5 mm ID	For use with tubing of OD 0.45 mm	10
SilFlow Ferrules 0.7 mm ID	For use with tubing of OD 0.68 mm	10
SilFlow Ferrules 0.8 mm ID	For use with tubing of OD 0.79 mm	10
SilFlow Nuts	–	10
SilFlow Blanking Pins	–	5
SilTite FingerTite Tool	–	1

For more information about this product visit [www.sge.com](http://www.sge.com) or contact [techsupport@sge.com](mailto:techsupport@sge.com).



## Connections | GC Deans' Switch SilFlow®

Improve Your GC Connectivity

Part Number	Part Description and Detail
123703	Deans' Switch Kit (Includes 1.1 mm OD Tubing)
123726	Microchannel Device Only Deans' Switch
<b>Replacement Parts</b>	
123704	SilFlow Nuts, PK10
123713	SilFlow Ferrules 0.35 mm ID, PK10
123706	SilFlow Ferrules 0.4 mm ID, PK10
123707	SilFlow Ferrules 0.5 mm ID, PK10
123709	SilFlow Ferrules 0.7 mm ID, PK10
123705	SilFlow Ferrules 1.1 mm ID, PK5
123715	SilFlow Blanking Ferrules and Pins, PK5
123717	SilTite Fingertite Tool
123743	SilFlow Ferrules 0.55 mm ID, PK10
123744	SilFlow Ferrules 0.75 mm ID, PK10
123742	SilFlow Ferrules 0.8 mm ID, PK10
123755	SilFlow Stainless Steel Capillary Tubing, 75 cm Long, 1.1 mm OD Sleeved to 1/16 " at One End (Not Included In Kits, Must Be Purchased Separately If Required)

For more information about this product visit [www.sge.com](http://www.sge.com) or contact [techsupport@sge.com](mailto:techsupport@sge.com).

## Connections | HPLC EasyLok™

### Quick and Easy HPLC Connections

EasyLok™ fittings are composed of a knurled stainless steel nut and a double ended PEEK ferrule. The PEEK ferrule simply slides over any 1/16" OD tubing to its required position, while the nut is finger tightened. Unlike stainless steel, the PEEK ferrule will not crush the tubing and can be easily readjusted for quick column changes.

#### Features and Benefits

- Double ended ferrule seals at two points.
- Knurled to make finger tightening easy.

#### Recommended Applications

The fittings are compatible with any standard female HPLC fitting including Swagelok®, Parker™, Waters®, Valco® and Whatman®.



---

#### Product Specifications

- Materials: PEEK double ended ferrules, stainless steel knurled nut.
- Pressure Rating: 5,000 psi.
- Temperature Rating: 150 °C.
- Thread Type: 10 - 32.

For more information about this product visit [www.sge.com](http://www.sge.com) or contact [techsupport@sge.com](mailto:techsupport@sge.com).

## Connections | HPLC EasyLok™

### Quick and Easy HPLC Connections

Part Number	Part Description and Detail
206102	EasyLok Fitting, 2 Fittings & 2 Ferrules
<b>Replacement Parts</b>	
206160	PEEK Double Ended Ferrules, PK10

For more information about this product visit [www.sge.com](http://www.sge.com) or contact [techsupport@sge.com](mailto:techsupport@sge.com).

## Connections | HPLC Fittings PEEK Fingertight

SGE PEEK Fingertight fittings are precision manufactured to complement your HPLC needs.

### Features and Benefits

Precision manufactured and low stress for your HPLC tubing.

### Recommended Applications

Recommended for all HPLC connections, particularly where PEEK or PEEKsil® tubing is used.



### Product Specifications

Description	Pressure Rating (psi)
1/16" to 10-32 UNF	5000
1/32" to 10-32 UNF	5000
1/32" to 10-32 UNF (long)	5000
1/32" to 6-40 UNF	2750

For more information about this product visit [www.sge.com](http://www.sge.com) or contact [techsupport@sge.com](mailto:techsupport@sge.com).

## Connections | HPLC Fittings PEEK Fingertight

Part Number	Part Description and Detail
2062752	1/16 " to 10-32UNF Thread, PK5
2062753	1/32 " to 10-32UNF Thread, (Long), PK5
222002	1/32 " to 10-32UNF Thread, PK5
222017	1/32 " to 6-40UNF Thread, PK5

For more information about this product visit [www.sge.com](http://www.sge.com) or contact [techsupport@sge.com](mailto:techsupport@sge.com).

## Connections | HPLC Hexnut™

### Quick and Easy HPLC Connections

Ideal for applications where corrosive solvents are being used, Hexnuts™ have inert contact surfaces, making them biocompatible. Stainless steel 10-32 thread fittings use a non-swaging Kel-F® or PEEK replaceable ferrule.



#### Features and Benefits

- Stainless steel 10-32 thread fittings use a non-swaging Kel-F or PEEK replaceable ferrule.
- Inert contact surfaces make them bio compatible.
- Ideal for applications where corrosive solvents are being used.

#### Recommended Applications

- Biotechnology.
- Medical research.
- Proteomics.
- Pharmaceuticals.
- Recommended for all HPLC connections, particularly where PEEK or PEEKsil® tubing is used.

---

#### Product Specifications

- Maximum Pressure Rating: 5,000 psi
- Thread Type: 10-32

For more information about this product visit [www.sge.com](http://www.sge.com) or contact [techsupport@sge.com](mailto:techsupport@sge.com).

## Connections | HPLC Hexnut™

### Quick and Easy HPLC Connections

Part Number	Part Description and Detail
1021003	Stainless Steel Hexnuts and PEEK Ferrules, 2 Hexnuts & 2 Ferrules
1021011	Stainless Steel Hexnuts and PEEK Ferrules, 10 Hexnuts & 10 Ferrules
<b>Replacement Parts</b>	
0730010	Kel-F Ferrules, PK10
0730014	Replacement PEEK Ferrules, PK10

For more information about this product visit [www.sge.com](http://www.sge.com) or contact [techsupport@sge.com](mailto:techsupport@sge.com).

## Connections | HPLC Unions

### Perfect Connections, Every Time

SGE HPLC Unions are specifically designed and precision engineered for use in capillary LC. The ideal way to avoid any void or dead volume in a connection is to achieve a faultless butt connection.

#### Features and Benefits

- Zero dead volume design for no peak dispersion.
- Easy to use.
- Complete versatility - allows connection to the same or different sized tubing.
- Available in PEEK and stainless steel.
- Stainless steel unions can be finger tightened or tightened with a 3/16" wrench for high-pressure applications.
- PEEK unions can be finger tightened. They are slightly larger than stainless steel unions but also lighter - less stress on your tubing.

#### Recommended Applications

ProteCol® Unions and reusable PEEK ferrules allow you to connect any combination of:

- 1/32" PEEKsil®.
- 1/16" PEEKsil.
- 0.36 mm fused silica tubing.

Use for connecting guard or trap columns to analytical columns, or for bypassing the analytical column.

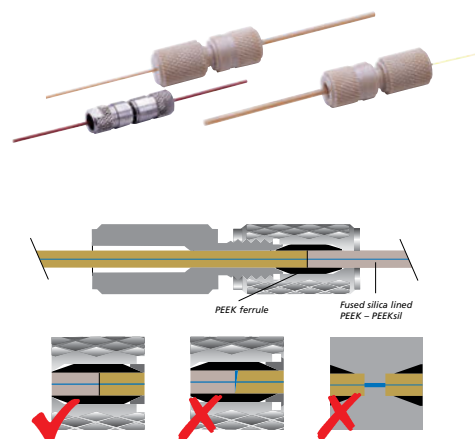

#### Product Specifications

ProteCol unions are available in either stainless steel or PEEK (for all sizes). All use the same range of reusable PEEK ferrules.

Pressure Rating 5000 psi for the stainless steel unions, 2175 psi for the PEEK unions.

##### ProteCol Stainless Steel Unions

Description
0.36 mm to 0.36 mm
1/16" to 0.36 mm
1/16" to 1/16"
1/16" to 1/32"
1/32" to 0.36 mm
1/32" to 1/32"

##### ProteCol PEEK Unions

Description
0.36 mm to 0.36 mm
1/16" to 0.36 mm
1/16" to 1/16"
1/16" to 1/32"
1/32" to 0.36 mm
1/32" to 1/32"

##### ProteCol PEEK Ferrules

Description
0.36 mm to 0.36 mm
1/16" to 0.36 mm
1/16" to 1/16"
1/16" to 1/32"
1/32" to 0.36 mm
1/32" to 1/32"

For more information about this product visit [www.sge.com](http://www.sge.com) or contact [techsupport@sge.com](mailto:techsupport@sge.com).



## Connections | HPLC Unions

Perfect Connections, Every Time

Part Number	Part Description and Detail
<b>ProteCol Stainless Steel Unions</b>	
211010	1/16 " to 1/16 " (1 Union Only - No Ferrules) ProteCol Stainless Steel Unions
212006	1/16 " to 1/16 " (2 Unions & 4 PEEK Ferrules) ProteCol Stainless Steel Unions
212007	1/16 " to 1/32 " (2 Unions & 4 PEEK Ferrules) ProteCol Stainless Steel Unions
212008	1/16 " to 0.36 mm (2 Unions & 4 PEEK Ferrules) ProteCol Stainless Steel Unions
222005	1/32 " to 1/32 " (2 Unions & 4 PEEK Ferrules) ProteCol Stainless Steel Unions
222006	1/32 " to 0.36 mm (2 Unions & 4 PEEK Ferrules) ProteCol Stainless Steel Unions
222007	0.36 mm to 0.36 mm (2 Unions & 4 PEEK Ferrules) ProteCol Stainless Steel Unions
<b>ProteCol PEEK Unions</b>	
212009	1/16 " to 1/16 " (2 Unions & 4 PEEK Ferrules) ProteCol PEEK Unions
212010	1/16 " to 1/32 " (2 Unions & 4 PEEK Ferrules) ProteCol PEEK Unions
212011	1/16 " to 0.36 mm (2 Unions & 4 PEEK Ferrules) ProteCol PEEK Unions
222009	1/32 " to 1/32 " (2 Unions & 4 PEEK Ferrules) ProteCol PEEK Unions
222010	1/32 " to 0.36 mm (2 Unions & 4 PEEK Ferrules) ProteCol PEEK Unions
222011	0.36 mm to 0.36 mm (2 Unions & 4 PEEK Ferrules) ProteCol PEEK Unions
<b>ProteCol PEEK Ferrules</b>	
213006	1/16 " to 1/16 ", ProteCol PEEK Ferrules PK5
213007	1/16 " to 1/32 ", ProteCol PEEK Ferrules PK5
213008	1/16 " to 0.36 mm, ProteCol PEEK Ferrules PK5
223005	1/32 " to 1/32 ", ProteCol PEEK Ferrules PK5
223006	1/32 " to 0.36 mm, ProteCol PEEK Ferrules PK5
223007	0.36 mm to 0.36 mm, ProteCol PEEK Ferrules PK5

For more information about this product visit [www.sge.com](http://www.sge.com) or contact [techsupport@sge.com](mailto:techsupport@sge.com).

## Connections | UHPLC Fittings PEEKTite™ Ti-Lok EXP

### Uncomplicated and Reliable UHPLC Connections for PEEKsil®

Finger tight nut and ferrule system specifically designed for use with PEEKsil® tubing, for both HPLC and UHPLC applications up to 18,000 psi (1,240 bar).

#### Features and Benefits

- Designed and validated by PEEKsil manufacturer for use with PEEKsil tubing to maximize the performance of your UHPLC system delivering an inert flow path and ultra high pressure performance up to 18,000 psi (1,240 bar).
- Compact in size allowing for use in port configurations where space is a premium (e.g. injection valve).
- Easy to install and leak-free, using the PEEKTite FingerTite tool.
- Fittings can be loosened and retightened for repeat use with any length of PEEKsil tubing.
- Zero dead volume for optimal peak shapes.



#### Recommended Applications

HPLC and UHPLC.

#### Product Specifications

PEEKTite Ti-Lok EXP UHPLC fittings are designed for use with:

- 1/32 " (0.79 mm) OD PEEKsil tubing in 6-32 and 6-40 port configurations.
- 1/16 " (1.6 mm) OD PEEKsil tubing in 10-32 port configurations.

PEEKsil is available in a variety of lengths and internal diameters catering for a wide range of system configurations and flow requirements.

#### PEEKsil Specifications

ID	OD	Tubing Lengths	Maximum Temperature
5 µm to 530 µm	1/32 ", 1/16 " and 0.36 mm	50, 100, 150, 250, 500 mm. Custom lengths are also available on request	100 °C

#### PEEKsil ID Tolerances for 1/32 " and 1/16 " Tubing

ID	25 µm ± 1	50 µm ± 3	75 µm ± 3	100 µm ± 3	150 µm ± 5	175 µm ± 5	200 µm ± 5	300 µm ± 5	530 µm ± 10
Color Code	Orange	Beige (Natural)	Black	Red	Purple	Yellow	Blue	Grey	Bone White

For more information about this product visit [www.sge.com](http://www.sge.com) or contact [techsupport@sge.com](mailto:techsupport@sge.com).

## Connections | UHPLC Fittings PEEKTite™ Ti-Lok EXP

### Uncomplicated and Reliable UHPLC Connections

Part Number	Part Description and Detail
<b>6-32 Port Configurations Suitable for 1/32 " PEEKsil</b>	
225000	PEEKTite Ti-Lok EXP UHPLC Fittings 1/32 " 6-32 Starter Kit (2 nuts, 2 ferrules, 1 FingerTite tool)
225002	PEEKTite Ti-Lok EXP UHPLC Fittings 1/32 " 6-32 Starter Kit (10 nuts, 10 ferrules, 1 FingerTite tool)
<b>6-40 Port Configurations Suitable for 1/32 " PEEKsil</b>	
225005	PEEKTite Ti-Lok EXP UHPLC Fittings 1/32 " 6-40 Starter Kit (2 nuts, 2 ferrules, 1 FingerTite tool)
225007	PEEKTite Ti-Lok EXP UHPLC Fittings 1/32 " 6-40 Starter Kit (10 nuts, 10 ferrules, 1 FingerTite tool)
<b>10-32 Port Configurations Suitable for 1/16 " PEEKsil</b>	
225010	PEEKTite Ti-Lok EXP UHPLC Fittings 1/16 " 10-32 Starter Kit (2 nuts, 2 ferrules, 1 FingerTite tool)
225012	PEEKTite Ti-Lok EXP UHPLC Fittings 1/16 " 10-32 Starter Kit (10 nuts, 10 ferrules, 1 FingerTite tool)
<b>PEEKTite FingerTite Tool</b>	
225021	PEEKTite Ti-Lok EXP UHPLC Fittings FingerTite Tool

For more information about this product visit [www.sge.com](http://www.sge.com) or contact [techsupport@sge.com](mailto:techsupport@sge.com).



Tubing



## Tubing | Stainless Steel

SGE stainless steel tubing is available in a number of different size combinations, suitable for your tubing needs.

### Features and Benefits

- Smooth and clean bore
- 5, 10 and 25 meter lengths supplied in coils. Where tubing OD is smaller than 1/16", ends are bushed to 1/16" and GC ferrules are supplied.
- 5, 10 and 25 meter lengths supplied cleaned and passivated.

### Recommended Applications

GC gas lines.



### Product Specifications

OD	ID	Length
1/48"	0.25 mm	25 m
1/32"	0.5 mm	25 m
1/8"	2.2 mm	5 m
1/16"	0.8 mm	10 m
1/16"	0.8 mm	5 m
1/8"	2.2 mm	2 m
1/16"	0.8 mm	2 m

For more information about this product visit [www.sge.com](http://www.sge.com) or contact [techsupport@sge.com](mailto:techsupport@sge.com).

## Tubing | Stainless Steel

Part Number	Part Description and Detail
062401	1/48 " OD x 0.25 mm ID x 25 m Length Stainless Steel Tubing
062406	1/32 " OD x 0.5 mm ID x 25 m Length Stainless Steel Tubing
062418	1/16 " OD x 0.8 mm ID x 2 m Length Stainless Steel Tubing
0624160	1/16 " OD x 0.8 mm ID x 5 m Length Stainless Steel Tubing
062416	1/16 " OD x 0.8 mm ID x 10 m Length Stainless Steel Tubing
0624173	1/8 " OD x 2.2 mm ID x 2 m Length Stainless Steel Tubing
062415	1/8 " OD x 2.2 mm ID x 5 m Length Stainless Steel Tubing

For more information about this product visit [www.sge.com](http://www.sge.com) or contact [techsupport@sge.com](mailto:techsupport@sge.com).

## Tubing | Glass Lined Tubing (GLT™)

### Combining Strength and Inertness

SGE GLT™ (Glass Lined Tubing) was invented and patented to address the problem of achieving a completely inert chromatographic system. It is made by fusing a borosilicate glass lining onto the inside surface of stainless steel tubing. GLT can either be used as straight tubing or it can be machined or shaped into virtually any chromatography accessory. The options are limitless.

#### Features and Benefits

- GLT is inert and has excellent resistance to strong acids and bases, unlike inferior silica coated brands.
- Biocompatible making it ideal for many HPLC applications.
- Mirror surface finish allows high HPLC column efficiencies.
- GLT is stable and withstands high temperatures to 500 °C.

#### Recommended Applications

GLT can be used for:

- Reactor tubing.
- Transfer lines or flow lines.
- Stack probes for environmental monitoring.
- HPLC columns for protein and biosensitive analyses.
- Mass spectrometer interfaces.
- Thermal desorption tubes.
- Inert tee pieces and unions.



---

#### Product Specifications

GLT comes in a wide range of sizes with ODs of 1/16 ", 1/8 ", 1/4 ", 1/2 " and IDs between 0.3 - 9.5 mm. GLT can be machined to form unions fittings and a range of other chromatography accessories.

For more information about this product visit [www.sge.com](http://www.sge.com) or contact [techsupport@sge.com](mailto:techsupport@sge.com).



## Tubing | Glass Lined Tubing (GLT™)

Combining Strength and Inertness

Part Number	Part Description and Detail
082707	1/16 " OD x 0.3 mm ID x 30 cm Length Glass Lined Tubing
082708	1/16 " OD x 0.3 mm ID x 60 cm Length Glass Lined Tubing
082710	1/16 " OD x 0.3 mm ID x 180 cm Length Glass Lined Tubing
082712	1/16 " OD x 0.4 mm ID x 30 cm Length Glass Lined Tubing
082717	1/16 " OD x 0.5 mm ID x 30 cm Length Glass Lined Tubing
082718	1/16 " OD x 0.5 mm ID x 60 cm Length Glass Lined Tubing
082719	1/16 " OD x 0.5 mm ID x 90 cm Length Glass Lined Tubing
082720	1/16 " OD x 0.5 mm ID x 180 cm Length Glass Lined Tubing
082724	1/16 " OD x 0.7 mm ID x 90 cm Length Glass Lined Tubing
082725	1/16 " OD x 0.7 mm ID x 180 cm Length Glass Lined Tubing
0827352	1/16 " OD x 0.8 mm ID x 30 cm Length Glass Lined Tubing
0827353	1/16 " OD x 0.8 mm ID x 60 cm Length Glass Lined Tubing
0827375	1/8 " OD x 0.5 mm ID x 30 cm Length Glass Lined Tubing
082734	1/8 " OD x 0.75 mm ID x 90 cm Length Glass Lined Tubing
082737	1/8 " OD x 1.0 mm ID x 30 cm Length Glass Lined Tubing
082738	1/8 " OD x 1.0 mm ID x 60 cm Length Glass Lined Tubing
082740	1/8 " OD x 1.0 mm ID x 180 cm Length Glass Lined Tubing
082742	1/8 " OD x 1.5 mm ID x 30 cm Length Glass Lined Tubing
082745	1/8 " OD x 1.5 mm ID x 180 cm Length Glass Lined Tubing
082747	1/8 " OD x 1.8 mm ID x 30 cm Length Glass Lined Tubing
0827571	1/4 " OD x 1.0 mm ID x 90 cm Length Glass Lined Tubing
082760	1/4 " OD x 2.0 mm ID x 90 cm Length Glass Lined Tubing
082767	1/4 " OD x 4.0 mm ID x 30 cm Length Glass Lined Tubing
082768	1/4 " OD x 4.0 mm ID x 60 cm Length Glass Lined Tubing
082770	1/4 " OD x 4.0 mm ID x 180 cm Length Glass Lined Tubing
08277028	1/2 " OD x 9.5 mm ID x 60 cm Length Glass Lined Tubing

For more information about this product visit [www.sge.com](http://www.sge.com) or contact [techsupport@sge.com](mailto:techsupport@sge.com).

## Tubing | PEEKsil®

### Fused Silica Lined PEEK

PEEKsil® is constructed from a core of smooth precision bore fused silica tubing bonded to a PEEK outer sheath. It is manufactured to exacting tolerances of bore size and concentricity, for reproducible flow rates and reliable connections.

The separation achieved is easily lost in tubing and connectors as a result of dispersion. PEEKsil reduces dispersion and therefore loss of efficiency, sensitivity and resolution.

#### Features and Benefits

- Inert smooth flow path, to minimize band broadening.
- Precise inside bore diameter.
- Flexible and robust.
- Lower sample carry over.
- Color coded for easy identification of internal diameter.
- Perfectly square cut and polished ends.
- Capable of withstanding high pressures.
- Effective pH range of 0-10 (not compatible with hydrofluoric acid).
- Compatible with most organic solvents (unlike PEEK).

#### Recommended Applications

HPLC and LC-MS.



#### Product Specifications

PEEKsil is available in a variety of lengths and internal diameters catering for a wide range of system configurations and flow requirements.

##### PEEKsil Specifications

ID	OD	Tubing Lengths	Maximum Temperature
5 µm to 530 µm	1/32 ", 1/16 " and 0.36 mm	50, 100, 150, 250, 500 mm. Custom lengths are also available on request	100 °C

##### PEEKsil ID Tolerances for 1/32 " and 1/16 " Tubing

ID	25 µm ± 1	50 µm ± 3	75 µm ± 3	100 µm ± 3	150 µm ± 5	175 µm ± 5	200 µm ± 5	300 µm ± 5	530 µm ± 10
Color Code	Orange	Beige (Natural)	Black	Red	Purple	Yellow	Blue	Grey	Bone White

For more information about this product visit [www.sge.com](http://www.sge.com) or contact [techsupport@sge.com](mailto:techsupport@sge.com).

## Tubing | PEEKsil®

### Fused Silica Lined PEEK

Part Number	Part Description and Detail
0624241	1/32 " OD x 0.025 mm ID x 50 mm Length PEEKsil Tubing PK2
0624242	1/32 " OD x 0.025 mm ID x 100 mm Length PEEKsil Tubing PK2
0624243	1/32 " OD x 0.025 mm ID x 150 mm Length PEEKsil Tubing PK2
0624245	1/32 " OD x 0.025 mm ID x 250 mm Length PEEKsil Tubing PK2
0624249	1/32 " OD x 0.025 mm ID x 500 mm Length PEEKsil Tubing PK2
0624261	1/32 " OD x 0.050 mm ID x 50 mm Length PEEKsil Tubing PK2
0624262	1/32 " OD x 0.050 mm ID x 100 mm Length PEEKsil Tubing PK2
0624263	1/32 " OD x 0.050 mm ID x 150 mm Length PEEKsil Tubing PK2
0624265	1/32 " OD x 0.050 mm ID x 250 mm Length PEEKsil Tubing PK2
0624269	1/32 " OD x 0.050 mm ID x 500 mm Length PEEKsil Tubing PK2
0624271	1/32 " OD x 0.075 mm ID x 50 mm Length PEEKsil Tubing PK2
0624273	1/32 " OD x 0.075 mm ID x 150 mm Length PEEKsil Tubing PK2
0624275	1/32 " OD x 0.075 mm ID x 250 mm Length PEEKsil Tubing PK2
0624279	1/32 " OD x 0.075 mm ID x 500 mm Length PEEKsil Tubing PK2
0624311	1/32 " OD x 0.1 mm ID x 50 mm Length PEEKsil Tubing PK2
0624312	1/32 " OD x 0.1 mm ID x 100 mm Length PEEKsil Tubing PK2
0624313	1/32 " OD x 0.1 mm ID x 150 mm Length PEEKsil Tubing PK2
0624315	1/32 " OD x 0.1 mm ID x 250 mm Length PEEKsil Tubing PK2
0624319	1/32 " OD x 0.1 mm ID x 500 mm Length PEEKsil Tubing PK2
0624341	1/32 " OD x 0.15 mm ID x 50 mm Length PEEKsil Tubing PK2
0624342	1/32 " OD x 0.15 mm ID x 100 mm Length PEEKsil Tubing PK2
0624345	1/32 " OD x 0.15 mm ID x 250 mm Length PEEKsil Tubing PK2
0624349	1/32 " OD x 0.15 mm ID x 500 mm Length PEEKsil Tubing PK2
0624225	1/16 " OD x 0.025 mm ID x 50 mm Length PEEKsil Tubing PK5
0624226	1/16 " OD x 0.025 mm ID x 100 mm Length PEEKsil Tubing PK5
0624227	1/16 " OD x 0.025 mm ID x 150 mm Length PEEKsil Tubing PK5
0624228	1/16 " OD x 0.025 mm ID x 200 mm Length PEEKsil Tubing PK5
0624229	1/16 " OD x 0.025 mm ID x 500 mm Length PEEKsil Tubing PK2
0624251	1/16 " OD x 0.05 mm ID x 50 mm Length PEEKsil Tubing PK5
0624252	1/16 " OD x 0.05 mm ID x 100 mm Length PEEKsil Tubing PK5
0624254	1/16 " OD x 0.05 mm ID x 150 mm Length PEEKsil Tubing PK5
0624253	1/16 " OD x 0.05 mm ID x 200 mm Length PEEKsil Tubing PK5
0624250	1/16 " OD x 0.05 mm ID x 500 mm Length PEEKsil Tubing PK2
0624290	1/16 " OD x 0.075 mm ID x 50 mm Length PEEKsil Tubing PK5
0624291	1/16 " OD x 0.075 mm ID x 100 mm Length PEEKsil Tubing PK5
0624292	1/16 " OD x 0.075 mm ID x 150 mm Length PEEKsil Tubing PK5
0624293	1/16 " OD x 0.075 mm ID x 200 mm Length PEEKsil Tubing PK5
0624294	1/16 " OD x 0.075 mm ID x 500 mm Length PEEKsil Tubing PK2
0624301	1/16 " OD x 0.1 mm ID x 50 mm Length PEEKsil Tubing PK5
0624302	1/16 " OD x 0.1 mm ID x 100 mm Length PEEKsil Tubing PK5
0624304	1/16 " OD x 0.1 mm ID x 150 mm Length PEEKsil Tubing PK5
0624303	1/16 " OD x 0.1 mm ID x 200 mm Length PEEKsil Tubing PK5
0624300	1/16 " OD x 0.1 mm ID x 500 mm Length PEEKsil Tubing PK2
0624230	1/16 " OD x 0.15 mm ID x 50 mm Length PEEKsil Tubing PK5
0624231	1/16 " OD x 0.15 mm ID x 100 mm Length PEEKsil Tubing PK5
0624232	1/16 " OD x 0.15 mm ID x 150 mm Length PEEKsil Tubing PK5
0624233	1/16 " OD x 0.15 mm ID x 200 mm Length PEEKsil Tubing PK5
0624234	1/16 " OD x 0.15 mm ID x 500 mm Length PEEKsil Tubing PK2
0624351	1/16 " OD x 0.175 mm ID x 50 mm Length PEEKsil Tubing PK5
0624352	1/16 " OD x 0.175 mm ID x 100 mm Length PEEKsil Tubing PK5
0624354	1/16 " OD x 0.175 mm ID x 150 mm Length PEEKsil Tubing PK5
0624353	1/16 " OD x 0.175 mm ID x 200 mm Length PEEKsil Tubing PK5

Part Number	Part Description and Detail
0624350	1/16 " OD x 0.175 mm ID x 500 mm Length PEEKsil Tubing PK2
0624202	1/16 " OD x 0.2 mm ID x 50 mm Length PEEKsil Tubing PK5
0624203	1/16 " OD x 0.2 mm ID x 100 mm Length PEEKsil Tubing PK5
0624205	1/16 " OD x 0.2 mm ID x 150 mm Length PEEKsil Tubing PK5
0624204	1/16 " OD x 0.2 mm ID x 200 mm Length PEEKsil Tubing PK5
0624201	1/16 " OD x 0.2 mm ID x 500 mm Length PEEKsil Tubing PK2
0624214	1/16 " OD x 0.3 mm ID x 50 mm Length PEEKsil Tubing PK5
0624215	1/16 " OD x 0.3 mm ID x 100 mm Length PEEKsil Tubing PK5
0624216	1/16 " OD x 0.3 mm ID x 150 mm Length PEEKsil Tubing PK5
0624217	1/16 " OD x 0.3 mm ID x 200 mm Length PEEKsil Tubing PK5
0624218	1/16 " OD x 0.3 mm ID x 500 mm Length PEEKsil Tubing PK2
0624365	1/16 " OD x 0.53 mm ID x 50 mm Length PEEKsil Tubing PK5
0624366	1/16 " OD x 0.53 mm ID x 100 mm Length PEEKsil Tubing PK5
0624367	1/16 " OD x 0.53 mm ID x 150 mm Length PEEKsil Tubing PK5
0624370	1/16 " OD x 0.53 mm ID x 500 mm Length PEEKsil Tubing PK2
0624371	0.36 mm OD x 0.025 mm ID x 50 mm Length PEEKsil Tubing PK2
0624372	0.36 mm OD x 0.025 mm ID x 100 mm Length PEEKsil Tubing PK2
0624373	0.36 mm OD x 0.025 mm ID x 150 mm Length PEEKsil Tubing PK2
0624374	0.36 mm OD x 0.025 mm ID x 250 mm Length PEEKsil Tubing PK2
0624375	0.36 mm OD x 0.025 mm ID x 500 mm Length PEEKsil Tubing PK2
0624376	0.36 mm OD x 0.050 mm ID x 50 mm Length PEEKsil Tubing PK2
0624377	0.36 mm OD x 0.050 mm ID x 100 mm Length PEEKsil Tubing PK2
0624378	0.36 mm OD x 0.050 mm ID x 150 mm Length PEEKsil Tubing PK2
0624379	0.36 mm OD x 0.050 mm ID x 250 mm Length PEEKsil Tubing PK2
0624380	0.36 mm OD x 0.050 mm ID x 500 mm Length PEEKsil Tubing PK2

For more information visit [www.sge.com](http://www.sge.com) or contact [techsupport@sge.com](mailto:techsupport@sge.com).



# Tubing | UHPLC Column Hardware ProteCol® Bio-Inert

## Smooth and Inert Glass Lining Optimizing UHPLC Bio Applications

ProteCol® Bio-Inert UHPLC column hardware provides the foundation for improved separations and analysis.

Traditional UHPLC column hardware is made from stainless steel which may influence the behaviour of analytes with known metal chelating activity. The surface roughness of stainless steel column hardware also contributes to the dispersion effects, resulting in lower performance of the column.

ProteCol Bio-Inert UHPLC column hardware is glass lined, providing substantial improvements in smoothness and inertness to optimize the analysis.

### Features and Benefits

- Improved column performance for bio applications.
- Designed for continuous use at 20,000 psi (1,379 bar).
- Optimize the performance of your phase.

### Recommended Applications

UHPLC bio applications.



---

### Product Specifications

- ID configurations: 1.0 mm and 2.1 mm.
- Length configurations: 30 mm, 50 mm, 100 mm and 150 mm.

For more information about this product visit [www.sge.com](http://www.sge.com) or contact [techsupport@sge.com](mailto:techsupport@sge.com).

# Tubing | UHPLC Column Hardware ProteCol® Bio-Inert

## Smooth and Inert Glass Lining for Optimal UHPLC Bio Applications

Part Number	Part Description and Detail
<b>Column Assemblies</b>	
08291545	30 mm Length x 1.0 mm ID ProteCol Bio-Inert UHPLC Glass Lined Column 6-32 Thread
08291546	30 mm Length x 1.0 mm ID ProteCol Bio-Inert UHPLC Glass Lined Column 6-32 Thread 0.5 µm Frit
08291547	30 mm Length x 1.0 mm ID ProteCol Bio-Inert UHPLC Glass Lined Column 6-32 Thread 2.0 µm Frit
08291540	30 mm Length x 1.0 mm ID ProteCol Bio-Inert UHPLC Glass Lined Column 10-32 Thread
08291541	30 mm Length x 1.0 mm ID ProteCol Bio-Inert UHPLC Glass Lined Column 10-32 Thread 0.5 µm Frit
08291542	30 mm Length x 1.0 mm ID ProteCol Bio-Inert UHPLC Glass Lined Column 10-32 Thread 2.0 µm Frit
08291535	30 mm Length x 2.1 mm ID ProteCol Bio-Inert UHPLC Glass Lined Column 6-32 Thread
08291536	30 mm Length x 2.1 mm ID ProteCol Bio-Inert UHPLC Glass Lined Column 6-32 Thread 0.5 µm Frit
08291537	30 mm Length x 2.1 mm ID ProteCol Bio-Inert UHPLC Glass Lined Column 6-32 Thread 2.0 µm Frit
08291530	30 mm Length x 2.1 mm ID ProteCol Bio-Inert UHPLC Glass Lined Column 10-32 Thread
08291531	30 mm Length x 2.1 mm ID ProteCol Bio-Inert UHPLC Glass Lined Column 10-32 Thread 0.5 µm Frit
08291532	30 mm Length x 2.1 mm ID ProteCol Bio-Inert UHPLC Glass Lined Column 10-32 Thread 2.0 µm Frit
08291445	50 mm Length x 1.0 mm ID ProteCol Bio-Inert UHPLC Glass Lined Column 6-32 Thread
08291446	50 mm Length x 1.0 mm ID ProteCol Bio-Inert UHPLC Glass Lined Column 6-32 Thread 0.5 µm Frit
08291447	50 mm Length x 1.0 mm ID ProteCol Bio-Inert UHPLC Glass Lined Column 6-32 Thread 2.0 µm Frit
08291440	50 mm Length x 1.0 mm ID ProteCol Bio-Inert UHPLC Glass Lined Column 10-32 Thread
08291441	50 mm Length x 1.0 mm ID ProteCol Bio-Inert UHPLC Glass Lined Column 10-32 Thread 0.5 µm Frit
08291442	50 mm Length x 1.0 mm ID ProteCol Bio-Inert UHPLC Glass Lined Column 10-32 Thread 2.0 µm Frit
08291435	50 mm Length x 2.1 mm ID ProteCol Bio-Inert UHPLC Glass Lined Column
08291436	50 mm Length x 2.1 mm ID ProteCol Bio-Inert UHPLC Glass Lined Column 6-32 Thread 0.5 µm Frit
08291437	50 mm Length x 2.1 mm ID ProteCol Bio-Inert UHPLC Glass Lined Column 6-32 Thread 2.0 µm Frit
08291430	50 mm Length x 2.1 mm ID ProteCol Bio-Inert UHPLC Glass Lined Column 10-32 Thread
08291431	50 mm Length x 2.1 mm ID ProteCol Bio-Inert UHPLC Glass Lined Column 10-32 Thread 0.5 µm Frit
08291432	50 mm Length x 2.1 mm ID ProteCol Bio-Inert UHPLC Glass Lined Column 10-32 Thread 2.0 µm Frit
08291345	100 mm Length x 1.0 mm ID ProteCol Bio-Inert UHPLC Glass Lined Column 6-32 Thread
08291346	100 mm Length x 1.0 mm ID ProteCol Bio-Inert UHPLC Glass Lined Column 6-32 Thread 0.5 µm Frit
08291347	100 mm Length x 1.0 mm ID ProteCol Bio-Inert UHPLC Glass Lined Column 6-32 Thread 2.0 µm Frit
08291340	100 mm Length x 1.0 mm ID ProteCol Bio-Inert UHPLC Glass Lined Column 10-32 Thread
08291341	100 mm Length x 1.0 mm ID ProteCol Bio-Inert UHPLC Glass Lined Column 10-32 Thread 0.5 µm Frit
08291342	100 mm Length x 1.0 mm ID ProteCol Bio-Inert UHPLC Glass Lined Column 10-32 Thread 2.0 µm Frit
08291335	100 mm Length x 2.1 mm ID ProteCol Bio-Inert UHPLC Glass Lined Column 6-32 Thread
08291336	100 mm Length x 2.1 mm ID ProteCol Bio-Inert UHPLC Glass Lined Column 6-32 Thread 0.5 µm Frit
08291337	100 mm Length x 2.1 mm ID ProteCol Bio-Inert UHPLC Glass Lined Column 6-32 Thread 2.0 µm Frit
08291330	100 mm Length x 2.1 mm ID ProteCol Bio-Inert UHPLC Glass Lined Column 10-32 Thread
08291331	100 mm Length x 2.1 mm ID ProteCol Bio-Inert UHPLC Glass Lined Column 10-32 Thread 0.5 µm Frit
08291332	100 mm Length x 2.1 mm ID ProteCol Bio-Inert UHPLC Glass Lined Column 10-32 Thread 2.0 µm Frit
08291245	150 mm Length x 1.0 mm ID ProteCol Bio-Inert UHPLC Glass Lined Column 6-32 Thread
08291246	150 mm Length x 1.0 mm ID ProteCol Bio-Inert UHPLC Glass Lined Column 6-32 Thread 0.5 µm Frit
08291247	150 mm Length x 1.0 mm ID ProteCol Bio-Inert UHPLC Glass Lined Column 6-32 Thread 2.0 µm Frit
08291240	150 mm Length x 1.0 mm ID ProteCol Bio-Inert UHPLC Glass Lined Column 10-32 Thread
08291241	150 mm Length x 1.0 mm ID ProteCol Bio-Inert UHPLC Glass Lined Column 10-32 Thread 0.5 µm Frit
08291242	150 mm Length x 1.0 mm ID ProteCol Bio-Inert UHPLC Glass Lined Column 10-32 Thread 2.0 µm Frit
08291235	150 mm Length x 2.1 mm ID ProteCol Bio-Inert UHPLC Glass Lined Column 6-32 Thread
08291236	150 mm Length x 2.1 mm ID ProteCol Bio-Inert UHPLC Glass Lined Column 6-32 Thread 0.5 µm Frit
08291237	150 mm Length x 2.1 mm ID ProteCol Bio-Inert UHPLC Glass Lined Column 6-32 Thread 2.0 µm Frit
08291230	150 mm Length x 2.1 mm ID ProteCol Bio-Inert UHPLC Glass Lined Column 10-32 Thread
08291231	150 mm Length x 2.1 mm ID ProteCol Bio-Inert UHPLC Glass Lined Column 10-32 Thread 0.5 µm Frit
08291232	150 mm Length x 2.1 mm ID ProteCol Bio-Inert UHPLC Glass Lined Column 10-32 Thread 2.0 µm Frit

Part Number	Part Description and Detail
<b>End Fittings</b>	
08290003	6-32 End Fittings for ProteCol Bio-Inert UHPLC 1.0 mm ID Columns Packet of 2
08290001	6-32 End Fittings for ProteCol Bio-Inert UHPLC 2.1 mm ID Columns Packet of 2
08290002	10-32 End Fittings for ProteCol Bio-Inert UHPLC 1.0 mm ID Columns Packet of 2
08290000	10-32 End Fittings for ProteCol Bio-Inert UHPLC 2.1 mm ID Columns Packet of 2
<b>Frit Assemblies</b>	
08290040	0.5 µm Titanium Frit Assembly for 1.0 mm ID ProteCol Bio-Inert UHPLC Glass Lined Columns Packet of 2
08290030	0.5 µm Titanium Frit Assembly for 2.1 mm ID ProteCol Bio-Inert UHPLC Glass Lined Columns Packet of 2
08290041	2.0 µm Titanium Frit Assembly for 1.0 mm ID ProteCol Bio-Inert UHPLC Glass Lined Columns Packet of 2
08290031	2.0 µm Titanium Frit Assembly for 2.1 mm ID ProteCol Bio-Inert UHPLC Glass Lined Columns Packet of 2
<b>Column Tubes</b>	
08290540	30 mm Length x 1.0 mm ID ProteCol Bio-Inert UHPLC Glass Lined Column Tubing
08290530	30 mm Length x 2.1 mm ID ProteCol Bio-Inert UHPLC Glass Lined Column Tubing
08290440	50 mm Length x 1.0 mm ID ProteCol Bio-Inert UHPLC Glass Lined Column Tubing
08290430	50 mm Length x 2.1 mm ID ProteCol Bio-Inert UHPLC Glass Lined Column Tubing
08290340	100 mm Length x 1.0 mm ID ProteCol Bio-Inert UHPLC Glass Lined Column Tubing
08290330	100 mm Length x 2.1 mm ID ProteCol Bio-Inert UHPLC Glass Lined Column Tubing
08290240	150 mm Length x 1.0 mm ID ProteCol Bio-Inert UHPLC Glass Lined Column Tubing
08290230	150 mm Length x 2.1 mm ID ProteCol Bio-Inert UHPLC Glass Lined Column Tubing

For more information visit [www.sge.com](http://www.sge.com) or contact [techsupport@sge.com](mailto:techsupport@sge.com).



## Tubing | Fused Silica

### Precision Tubing for Performance

Coated fused silica tubing exhibits excellent flexibility, chemical stability, tensile strength and exacting tolerances making it the tubing of choice for GC capillary applications, LC tubing and other micro tubing requirements.



#### Features and Benefits

- High homogeneity.
- 100% proof tested for strength.
- Excellent resistance to thermal shock.
- Chemical inertness.
- Standard polyimide temperature resistance to +380 °C – equivalent to other high temperature polyimides.
- Polyimide coating is chemically resistant.
- Low dielectric constant, low dielectric loss.
- Impermeable to all gases (except H<sub>2</sub>, He).
- Free of thermal hysteresis.
- Low weight loss (below devitrification temperature).
- Optical properties of uncoated – transparent above 180 nm.
- High intrinsic tensile strength.
- Uncoated, temperature resistant to 1000 °C.
- Pressure resistant to 1000 bar.
- Very low thermal expansion.
- Internal surface modification is available.

#### Recommended Applications

- Capillary GC.
- HPLC.
- Bioanalytical.
- High temperature GC.

Avoid use with hydrofluoric or phosphoric acids, alkalis and alkali-metalized compounds as dissolution of silica glass and surface devitrification may occur.

#### Product Specifications

ID	OD	Iron	Lithium	Sodium	Potassium	Magnesium	Manganese	Titanium	Chlorine	Zirconium
25 µm ± 1 µm	360 µm ± 15 µm	< 8 ppb	< 10 ppb	< 8 ppb	< 10 ppb	< 10 ppb	< 5 ppb	< 10 ppb	0 ppb	< 10 ppb
50 µm ± 3 µm	430 µm ± 20 µm									
75 µm ± 3 µm	680 µm ± 25 µm									
100 µm ± 3 µm										
150 µm ± 3 µm										
220 µm ± 5 µm										
250 µm ± 5 µm										
320 µm ± 5 µm										
530 µm ± 10 µm										

For more information about this product visit [www.sge.com](http://www.sge.com) or contact [techsupport@sge.com](mailto:techsupport@sge.com).



## Tubing | Fused Silica

### Precision Tubing for Performance

Part Number	Part Description and Detail
<b>Fused Silica Tubing</b>	
0624625	140 µm OD x 40 µm ID x 10 m Length Fused Silica Tubing
062461	150 µm OD x 25 µm ID x 10 m Length Fused Silica Tubing
0624635	150 µm OD x 50 µm ID x 10 m Length Fused Silica Tubing
062454	170 µm OD x 110 µm ID x 10 m Length Fused Silica Tubing
062457	170 µm OD x 110 µm ID x 25 m Length Fused Silica Tubing
062466	190 µm OD x 75 µm ID x 10 m Length Fused Silica Tubing
0624685	200 µm OD x 100 µm ID x 10 m Length Fused Silica Tubing
062463	220 µm OD x 50 µm ID x 10 m Length Fused Silica Tubing
0624655	220 µm OD x 60 µm ID x 10 m Length Fused Silica Tubing
062472	220 µm OD x 150 µm ID x 10 m Length Fused Silica Tubing
062473	220 µm OD x 150 µm ID x 25 m Length Fused Silica Tubing
062456	285 µm OD x 5 µm ID x 10 m Length Fused Silica Tubing
062458	285 µm OD x 10 µm ID x 10 m Length Fused Silica Tubing
062460	285 µm OD x 25 µm ID x 10 m Length Fused Silica Tubing
062474	285 µm OD x 150 µm ID x 10 m Length Fused Silica Tubing
062469	363 µm OD x 100 µm ID x 10 m Length Fused Silica Tubing
062470	363 µm OD x 100 µm ID x 25 m Length Fused Silica Tubing
062475	363 µm OD x 220 µm ID x 10 m Length Fused Silica Tubing
062476	363 µm OD x 220 µm ID x 25 m Length Fused Silica Tubing
062492	363 µm OD x 250 µm ID x 10 m Length Fused Silica Tubing
062478	430 µm OD x 320 µm ID x 10 m Length Fused Silica Tubing
062479	430 µm OD x 320 µm ID x 25 m Length Fused Silica Tubing
062481	680 µm OD x 530 µm ID x 10 m Length Fused Silica Tubing
062482	680 µm OD x 530 µm ID x 25 m Length Fused Silica Tubing
<b>Deactivated Fused Silica Tubing</b>	
062446	170 µm OD x 110 µm ID x 2 m Length Deactivated Fused Silica Tubing
0624450	190 µm OD x 75 µm ID x 2 m Length Deactivated Fused Silica Tubing
062444	220 µm OD x 50 µm ID x 2 m Length Deactivated Fused Silica Tubing
062445	220 µm OD x 60 µm ID x 2 m Length Deactivated Fused Silica Tubing
0624460	220 µm OD x 150 µm ID x 2 m Length Deactivated Fused Silica Tubing
0624461	220 µm OD x 150 µm ID x 5 m Length Deactivated Fused Silica Tubing
0624463	220 µm OD x 150 µm ID x 10 m Length Deactivated Fused Silica Tubing
062442	285 µm OD x 25 µm ID x 2 m Length Deactivated Fused Silica Tubing
0624491	300 µm OD x 170 µm ID x 2 m Length Deactivated Fused Silica Tubing
062449	300 µm OD x 170 µm ID x 5 m Length Deactivated Fused Silica Tubing
0624459	310 µm OD x 110 µm ID x 2 m Length Deactivated Fused Silica Tubing
06244503	363 µm OD x 50 µm ID x 2 m Length Deactivated Fused Silica Tubing
06244502	363 µm OD x 75 µm ID x 2 m Length Deactivated Fused Silica Tubing
0624455	363 µm OD x 100 µm ID x 25 m Length Deactivated Fused Silica Tubing
06244501	363 µm OD x 125 µm ID x 2 m Length Deactivated Fused Silica Tubing
0624465	363 µm OD x 150 µm ID x 2 m Length Deactivated Fused Silica Tubing
0624475	363 µm OD x 150 µm ID x 5 m Length Deactivated Fused Silica Tubing
0624469	363 µm OD x 220 µm ID x 2 m Length Deactivated Fused Silica Tubing
062447	363 µm OD x 220 µm ID x 5 m Length Deactivated Fused Silica Tubing
064050	363 µm OD x 220 µm ID x 5 m Length Deactivated Fused Silica Tubing PK5
0624478	363 µm OD x 220 µm ID x 10 m Length Deactivated Fused Silica Tubing
0624474	363 µm OD x 220 µm ID x 25 m Length Deactivated Fused Silica Tubing
0624431	363 µm OD x 250 µm ID x 2 m Length Deactivated Fused Silica Tubing
0624432	363 µm OD x 250 µm ID x 5 m Length Deactivated Fused Silica Tubing
064051	363 µm OD x 250 µm ID x 5 m Length Deactivated Fused Silica Tubing PK5
0624434	363 µm OD x 250 µm ID x 10 m Length Deactivated Fused Silica Tubing

Part Number	Part Description and Detail
0624470	430 µm OD x 320 µm ID x 2 m Length Deactivated Fused Silica Tubing
0624471	430 µm OD x 320 µm ID x 5 m Length Deactivated Fused Silica Tubing
064052	430 µm OD x 320 µm ID x 5 m Length Deactivated Fused Silica Tubing PK5
0624476	430 µm OD x 320 µm ID x 10 m Length Deactivated Fused Silica Tubing
0624473	430 µm OD x 320 µm ID x 25 m Length Deactivated Fused Silica Tubing
0624477	550 µm OD x 420 µm ID x 2 m Length Deactivated Fused Silica Tubing
0624479	680 µm OD x 530 µm ID x 2 m Length Deactivated Fused Silica Tubing
062448	680 µm OD x 530 µm ID x 5 m Length Deactivated Fused Silica Tubing
064054	680 µm OD x 530 µm ID x 5 m Length Deactivated Fused Silica Tubing PK5
064033	680 µm OD x 530 µm ID x 10 m Length Deactivated Fused Silica Tubing
064034	680 µm OD x 530 µm ID x 25 m Length Deactivated Fused Silica Tubing
<b>Phenyl Deactivated Fused Silica Tubing</b>	
064102	363 µm OD x 220 µm ID x 5 m Length Phenyl Deactivated Fused Silica Tubing
064103	363 µm OD x 220 µm ID x 10 m Length Phenyl Deactivated Fused Silica Tubing
064061	363 µm OD x 250 µm ID x 5 m Length Phenyl Deactivated Fused Silica Tubing
064062	363 µm OD x 250 µm ID x 10 m Length Phenyl Deactivated Fused Silica Tubing
064108	430 µm OD x 320 µm ID x 5 m Length Phenyl Deactivated Fused Silica Tubing
064114	680 µm OD x 530 µm ID x 5 m Length Phenyl Deactivated Fused Silica Tubing
<b>Undeactivated Fused Silica Tubing</b>	
062711	363 µm OD x 5 µm ID x Sold Per Meter as a Continuous Length Undeactivated Fused Silica Tubing
062710	363 µm OD x 25 µm ID x Sold Per Meter as a Continuous Length Undeactivated Fused Silica Tubing
062712	363 µm OD x 75 µm ID x Sold Per Meter as a Continuous Length Undeactivated Fused Silica Tubing
062714	363 µm OD x 100 µm ID x Sold Per Meter as a Continuous Length Undeactivated Fused Silica Tubing
062713	363 µm OD x 150 µm ID x Sold Per Meter as a Continuous Length Undeactivated Fused Silica Tubing

For more information visit [www.sge.com](http://www.sge.com) or contact [techsupport@sge.com](mailto:techsupport@sge.com).



## Tubing | MyCapLC™ Kit

### Customize CapLC for Your Application

MyCapLC™ Kit enables you to create your own capillary columns with your HPLC pump and the simple packing instructions. You can easily pack your own capillary columns in a matter of hours.

#### Features and Benefits

- DIY capillary column packing, no special pumps or instrumentation required.
- Quick, convenient and cost effective solution for capillary columns.
- Robust and easy to pack hardware.

#### Recommended Applications

Perfect for life sciences and omic analysis.

#### Product Specifications

MyCapLC Kit (suitable to pack three columns):

- 0.1 g C18 3  $\mu\text{m}$  200  $\text{\AA}$
- 1 x Slurry reservoir (50 mm x 2.1 mm ID column tubing)
- 2 x End fittings with inserted PEEK sealing rings
- 1 x PEEK Fingertight fitting
- 3 x Column bodies (1/16" OD PEEKsil®, lengths from 50 mm - 150 mm and IDs from 150  $\mu\text{m}$  - 530  $\mu\text{m}$ )
- 6 x Connection capillaries (1/32" and 1/16" OD options available in 50  $\mu\text{m}$  ID. Inlet length is 250 mm. Outlet length is 100 mm)
- 6 x Male unions (1/16")
- 6 x Female unions (1/32")
- 6 x PEEK double ended ferrules (1/16"-1/32") with 0.5  $\mu\text{m}$  woven mesh filters
- 2 x Wrenches



For more information about this product visit [www.sge.com](http://www.sge.com) or contact [techsupport@sge.com](mailto:techsupport@sge.com).

## Tubing | MyCapLC™ Kit

### Customize CapLC for Your Application

Part Number	Part Description and Detail
2251110	MyCapLC Kit Containing Components to Assemble Three Complete 1/16 " OD x 150 µm ID x 50 mm Length UHPLC Columns, with 250 mm Inlet and 100 mm Outlet Tails 360 µm OD x 50 µm ID
2251111	MyCapLC Kit Containing Components to Assemble Three Complete 1/16 " OD x 150 µm ID x 50 mm Length UHPLC Columns, with 250 mm Inlet and 100 mm Outlet Tails 1/32 " OD x 50 µm ID
2251210	MyCapLC Kit Containing Components to Assemble Three Complete 1/16 " OD x 150 µm ID x 100 mm Length UHPLC Columns, with 250 mm Inlet and 100 mm Outlet Tails 360 µm OD x 50 µm ID
2251211	MyCapLC Kit Containing Components to Assemble Three Complete 1/16 " OD x 150 µm ID x 100 mm Length UHPLC Columns, with 250 mm Inlet and 100 mm Outlet Tails 1/32 " OD x 50 µm ID
2251310	MyCapLC Kit Containing Components to Assemble Three Complete 1/16 " OD x 150 µm ID x 150 mm Length UHPLC Columns, with 250 mm Inlet and 100 mm Outlet Tails 360 µm OD x 50 µm ID
2251311	MyCapLC Kit Containing Components to Assemble Three Complete 1/16 " OD x 150 µm ID x 150 mm Length UHPLC Columns, with 250 mm Inlet and 100 mm Outlet Tails 1/32 " OD x 50 µm ID
2251130	MyCapLC Kit Containing Components to Assemble Three Complete 1/16 " OD x 300 µm ID x 50 mm Length UHPLC Columns, with 250 mm Inlet and 100 mm Outlet Tails 360 µm OD x 50 µm ID
2251131	MyCapLC Kit Containing Components to Assemble Three Complete 1/16 " OD x 300 µm ID x 50 mm Length UHPLC Columns, with 250 mm Inlet and 100 mm Outlet Tails 1/32 " OD x 50 µm ID
2251230	MyCapLC Kit Containing Components to Assemble Three Complete 1/16 " OD x 300 µm ID x 100 mm Length UHPLC Columns, with 250 mm Inlet and 100 mm Outlet Tails 360 µm OD x 50 µm ID
2251231	MyCapLC Kit Containing Components to Assemble Three Complete 1/16 " OD x 300 µm ID x 100 mm Length UHPLC Columns, with 250 mm Inlet and 100 mm Outlet Tails 1/32 " OD x 50 µm ID
2251330	MyCapLC Kit Containing Components to Assemble Three Complete 1/16 " OD x 300 µm ID x 150 mm Length UHPLC Columns, with 250 mm Inlet and 100 mm Outlet Tails 360 µm OD x 50 µm ID
2251331	MyCapLC Kit Containing Components to Assemble Three Complete 1/16 " OD x 300 µm ID x 150 mm Length UHPLC Columns, with 250 mm Inlet and 100 mm Outlet Tails 1/32 " OD x 50 µm ID
2251151	MyCapLC Kit Containing Components to Assemble Three Complete 1/16 " OD x 530 µm ID x 50 mm Length UHPLC Columns, with 250 mm Inlet and 100 mm Outlet Tails 1/32 " OD x 50 µm ID
2251251	MyCapLC Kit Containing Components to Assemble Three Complete 1/16 " OD x 530 µm ID x 100 mm Length UHPLC Columns, with 250 mm Inlet and 100 mm Outlet Tails 1/32 " OD x 50 µm ID
2251351	MyCapLC Kit Containing Components to Assemble Three Complete 1/16 " OD x 530 µm ID x 150 mm Length UHPLC Columns, with 250 mm Inlet and 100 mm Outlet Tails 1/32 " OD x 50 µm ID

For more information about this product visit [www.sge.com](http://www.sge.com) or contact [techsupport@sge.com](mailto:techsupport@sge.com).

# Accessories

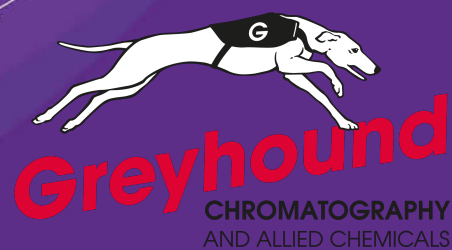

## Accessories | Advanced Gas Filter System

### Protect Your GC Column

Gas purifiers are an essential part of your GC analysis. Without the appropriate gas purifier, problems such as noisy baselines, moisture entering GC column, excessive bleed, reduced column lifetime and irreproducible results will occur. These problems are created by hydrocarbons, moisture and oxygen in the carrier gases.

#### Features and Benefits

The Advanced Gas Filter System (AFS) has high capacity and efficiency levels for :

- Oxygen (850 cc, < 5 ppb),
- Water (12 g, < 20 ppb), and
- Hydrocarbons (8 g, < 5 ppb).

Each connection in the AFS is made with two fluoro-elastomer seals. The polycarbonate shield that surrounds the glass indicator section of the filter is sealed, so the gas flow is secure even if the glass is broken.

#### Recommended Applications

Recommended for GC carrier or detector gas lines.

#### Product Specifications

The two part system includes a small stainless steel manifold and a high capacity filter cartridge. It can be attached to a laboratory wall or bench with the brackets included.

The recommended flow rate is 1 L/min and 200 psi maximum operating pressure.

Description	Fitting
Advanced Gas Filter System	1/8 "
Advanced Gas Filter System	1/4 "
Advanced Gas Filter System Replacement Cartridge	1/8 " and 1/4 "

For more information about this product visit [www.sge.com](http://www.sge.com) or contact [techsupport@sge.com](mailto:techsupport@sge.com).

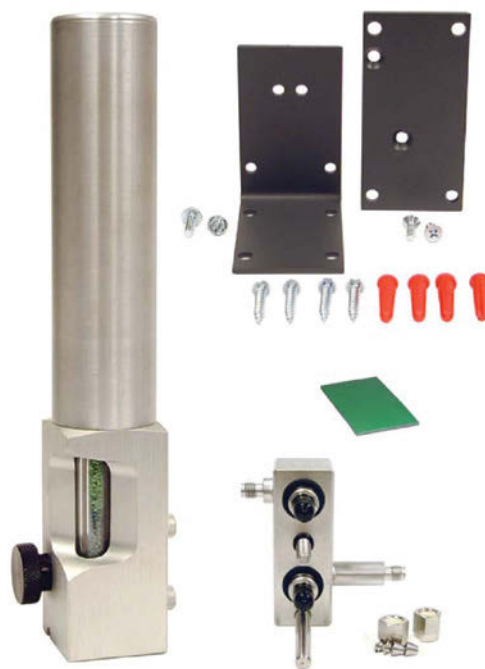

## Accessories | Advanced Gas Filter System

### Protect Your GC Column

Part Number	Part Description and Detail
1034884	1/8 " Fittings Advanced Gas Filter System
1034888	1/4 " Fittings Advanced Gas Filter System
<b>Replacement Part</b>	
1034886	Advanced Gas Filter System Replacement Cartridge

For more information about this product visit [www.sge.com](http://www.sge.com) or contact [techsupport@sge.com](mailto:techsupport@sge.com).

## Accessories | Hydrocarbon Trap

### Protect Your GC Column

Gas purifiers are an essential part of your GC analysis. Without the appropriate gas purifier, problems such as noisy baselines, moisture entering GC column, excessive bleed, reduced column lifetime and irreproducible results will occur. These problems are created by hydrocarbons, moisture and oxygen in the carrier gases.

#### Features and Benefits

The Hydrocarbon Trap removes C5 weight and heavier hydrocarbons from inert gases, air or hydrogen to low ppb levels. It has an impervious outer stainless steel casing.

#### Recommended Applications

Recommended for GC carrier or detector gas lines.

#### Product Specifications

Description	Fitting
Hydrocarbon Trap	1/8 "
Hydrocarbon Trap	1/4 "

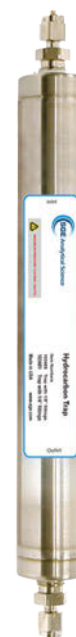

For more information about this product visit [www.sge.com](http://www.sge.com) or contact [techsupport@sge.com](mailto:techsupport@sge.com).



## Accessories | Hydrocarbon Trap

Protect Your GC Column

Part Number	Part Description and Detail
103488	1/8 " Fittings Hydrocarbon Trap
103481	1/4 " Fittings Hydrocarbon Trap

For more information about this product visit [www.sge.com](http://www.sge.com) or contact [techsupport@sge.com](mailto:techsupport@sge.com).

## Accessories | Indicating Oxygen Trap

### Protect Your GC Column

Gas purifiers are an essential part of your GC analysis. Without the appropriate gas purifier, problems such as noisy baselines, moisture entering GC column, excessive bleed, reduced column lifetime and irreproducible results will occur. These problems are created by hydrocarbons, moisture and oxygen in the carrier gases.

#### Features and Benefits

The Indicating Oxygen Trap is an improved, compact indicating filter for high-efficiency oxygen removal, suitable for use with chromatography carrier gas streams. It removes oxygen to low-ppb levels, with an indicator that changes color from green to gray when adsorption capacity is depleted. The adsorbent forms copper oxide in the presence of oxygen; no gas is generated. The adsorbents are held in a heavy-walled inner glass tube, shielded by an outer clear plastic tube for increased safety.

#### Recommended Applications

The Indicating Oxygen Trap is recommended as a downstream indicator for high-capacity oxygen traps. It can be used with non-oxidizing gases such as He, Ar, N<sub>2</sub>, H<sub>2</sub> or CH<sub>4</sub>.

#### Product Specifications

Approximate dimensions are 3.5 cm x 26 cm including fittings. Maximum pressure is 6.8 bar (100 psig).

Description	Fitting
Indicating Oxygen Trap	1/8 "
Indicating Oxygen Trap	1/4 "



For more information about this product visit [www.sge.com](http://www.sge.com) or contact [techsupport@sge.com](mailto:techsupport@sge.com).

## Accessories | Indicating Oxygen Trap

Protect Your GC Column

Part Number	Part Description and Detail
103491	1/8 " Fittings Indicating Oxygen Trap
1034911	1/4 " Fittings Indicating Oxygen Trap

For more information about this product visit [www.sge.com](http://www.sge.com) or contact [techsupport@sge.com](mailto:techsupport@sge.com).

## Accessories | Moisture Trap

### Protect Your GC Column

Gas purifiers are an essential part of your GC analysis. Without the appropriate gas purifier, problems such as noisy baselines, moisture entering GC column, excessive bleed, reduced column lifetime and irreproducible results will occur. These problems are created by hydrocarbons, moisture and oxygen in the carrier gases.

#### Features and Benefits

The Moisture Trap removes water from inert gases, air or hydrogen to less than 20 ppb at flow rates up to 2 L/min.

#### Recommended Applications

Recommended for GC carrier or detector gas lines.

#### Product Specifications

The trap has a capacity for water of 15 g.

Description	Fitting
Moisture Trap	1/8 "
Moisture Trap	1/4 "



For more information about this product visit [www.sge.com](http://www.sge.com) or contact [techsupport@sge.com](mailto:techsupport@sge.com).

## Accessories | Moisture Trap

### Protect Your GC Column

Part Number	Part Description and Detail
103487	1/8 " Fittings Moisture Trap
103480	1/4 " Fittings Moisture Trap

For more information about this product visit [www.sge.com](http://www.sge.com) or contact [techsupport@sge.com](mailto:techsupport@sge.com).

## Accessories | Oxygen Trap

### Protect Your GC Column

Gas purifiers are an essential part of your GC analysis. Without the appropriate gas purifier, problems such as noisy baselines, moisture entering GC column, excessive bleed, reduced column lifetime and irreproducible results will occur. These problems are created by hydrocarbons, moisture and oxygen in the carrier gases.

#### Features and Benefits

- Huge 2.5 L capacity; reduces O<sub>2</sub> to low ppb levels.
- Advanced adsorbent technology.
- Outstanding efficiency in a small, high performance design.

#### Recommended Applications

Recommended for GC carrier or detector gas lines.

#### Product Specifications

Description	Fitting
Oxygen Trap	1/8 "
Oxygen Trap	1/4 "

For more information about this product visit [www.sge.com](http://www.sge.com) or contact [techsupport@sge.com](mailto:techsupport@sge.com).



## Accessories | Oxygen Trap

### Protect Your GC Column

Part Number	Part Description and Detail
103486	1/8 " Fittings Oxygen Trap
103482	1/4 " Fittings Oxygen Trap

For more information about this product visit [www.sge.com](http://www.sge.com) or contact [techsupport@sge.com](mailto:techsupport@sge.com).

## Accessories | Packed Column Moisture Trap

### Protect Your GC Column

Gas purifiers are an essential part of your GC analysis. Without the appropriate gas purifier, problems such as noisy baselines, moisture entering GC column, excessive bleed, reduced column lifetime and irreproducible results will occur. These problems are created by hydrocarbons, moisture and oxygen in the carrier gases.

#### Features and Benefits

- Up to 6 grams water is removed to low ppb levels.
- The adsorbing materials are Molecular Sieve 5A and cobalt-free CoFree indicator, held in a sturdy glass tube.
- The gas to be purified contacts only glass, metal and the adsorbents. CoFree changes color from orange to green at about 5% relative humidity to signal depletion; the molecular sieve removes moisture to trace levels.
- The glass tube is sealed with a special dual sealing system for extra protection from leaks.
- An internal frit at each end prevents particulate contamination.
- The inner glass tube is enclosed in a plastic outer tube for safety.

#### Recommended Applications

These are gas filters for applications requiring high-efficiency moisture removal, with the benefit of a depletion indicator.



#### Product Specifications

Dimensions: 3.5 cm x 26 cm, maximum pressure 6.8 bar (100 psig).

Description	Fitting
Packed Column Moisture Trap	1/8 "
Packed Column Moisture Trap	1/4 "

For more information about this product visit [www.sge.com](http://www.sge.com) or contact [techsupport@sge.com](mailto:techsupport@sge.com).



## Accessories | Packed Column Moisture Trap

Protect Your GC Column

Part Number	Part Description and Detail
1034951	1/8 " Fittings Packed Column Glass Moisture Trap
103495	1/4 " Fittings Packed Column Glass Moisture Trap

For more information about this product visit [www.sge.com](http://www.sge.com) or contact [techsupport@sge.com](mailto:techsupport@sge.com).

## Accessories | Gas and Vapor Sampler

The Gas and Vapor sampler (GAV-200) is ideal for remote sampling of environmental or low pressure stream gases and vapor.

Samples are collected in a 200 cm<sup>3</sup> self-sealing, impervious bag which can be removed from the sampling canister for further sampling. The filled bags can be stored until discharge of the contents is required.

### Features and Benefits

- Easy to use.
- Ideal for field environmental analysis.
- Resealable/removable sample bags.
- 200 cm<sup>3</sup> sample bag capacity.

### Recommended Applications

Spot collection of environmental gas samples or low pressure gas streams.



### Product Specifications

Kit Contains:

- Canister,
- Bulb,
- 10 bags,
- Marker Pen, and
- Instructions.

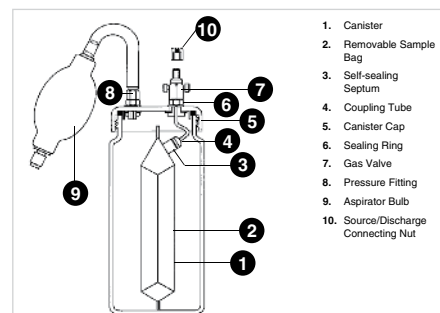

The GAV-200 gas sampling bags consist of a polyethylene/aluminum foil/polyethylene laminate. The sample bags are suitable for gas pressures differentials up to 5psi. The canister is polycarbonate with a polypropylene cap. The maximum canister pressure is 50 psi (350 kPa).

For more information about this product visit [www.sge.com](http://www.sge.com) or contact [techsupport@sge.com](mailto:techsupport@sge.com).

## Accessories | Gas and Vapor Sampler

Part Number	Part Description and Detail
090111	Gas and Vapor Sampling Kit (Contains Canister, Bulb, 10 Bags, Marker Pen and Instructions)
<b>Replacement Parts</b>	
040100	Replacement GAV-B Aspirator Bulb with Tubing
103404	Replacement BN-16 1/16 " Brass Nuts, PK5
090112	Replacement Sample Bags, PK10
090113	Replacement Septa, PK5
072650	PSR16-16 PTFE Sealing Ring

For more information about this product visit [www.sge.com](http://www.sge.com) or contact [techsupport@sge.com](mailto:techsupport@sge.com).

## Accessories | Syringe Valves

### Extraction to Injection in a Single Process

Syringe valves are ideal for sample storage and transportation, or to pressurize sample prior to injection. The valve allows fluid to be stored in the syringe without contamination.

SGE Luer Tip, Luer Lock and removable needle syringes can be fitted with valves.

Available in two configurations of manually operated syringe valves; push-pull for smaller volumes (25  $\mu$ L – 2.5 mL), and push-button for larger volumes (5 mL – 2 L).

#### Recommended Applications

Sample storage and transportation. Pressurizing samples prior to injection.



*Push-pull Valve  
with Luer Lock*



*Push-button Valve  
with Luer Lock or  
removable needle*



*Push-button Valve  
for Luer Lock devices*

#### Product Specifications

- Push-pull valve with replaceable cone tip needle available for 25  $\mu$ L - 2.5 mL removable needle syringes.
- Push-button valve with Luer Lock termination available for 5 mL - 2 L syringes with removable Luer Lock or removable needle.
- Push-button Luer Lock valve available for any Luer Lock or Luer Tip syringe, or other Luer devices.

For more information about this product visit [www.sge.com](http://www.sge.com) or contact [techsupport@sge.com](mailto:techsupport@sge.com).

## Accessories | Syringe Valves

### Extraction to Injection in a Single Process

Part Number	Part Description And Detail
031905	Push-Pull Valve with Replaceable 5 cm Long, 0.63 mm OD, Cone Tip Needle. Suits 25 $\mu$ L-2.5 mL Removable Needle Syringes
031907	Push-Pull Valve with Luer Lock Termination. Suits 25 $\mu$ L-2.5 mL Removable Needle Syringes
031910	Push Button Valve with Luer Lock Termination. Suits 5 mL-2L Syringes with Removable Luer Lock or Removable Needle
031915	Luer Lock Valve For Any Luer Lock and Luer Tip Syringes or Other Luer Devices
<b>Replacement Part</b>	
038810	Replacement Needle For 031905

For more information about this product visit [www.sge.com](http://www.sge.com) or contact [techsupport@sge.com](mailto:techsupport@sge.com).

## Accessories | Valves High Performance

SGE High Performance valves are offered in micro control or pneumatic format delivering gas control in the best format for your analytical science needs.

### Features and Benefits

Designed specifically for chromatography applications. Can be used at elevated temperatures from high vacuum to medium pressure.

Vacuum rated to a leak rate of  $1 \times 10^{-5}$  cc/sec of Helium except for BMCV and SMOV, which are not vacuum tested.

- Minimal exposure to stainless steel.
- Fully swept flow path.
- Replaceable graphitized Vespel® seat.
- Range of stem lengths where appropriate.
- Easy installation.
- Maintenance instructions, spare seals and seats are provided with each unit.
- Minimal dead volume.

### Recommended Applications

Fine control of gas for all analytical science needs.

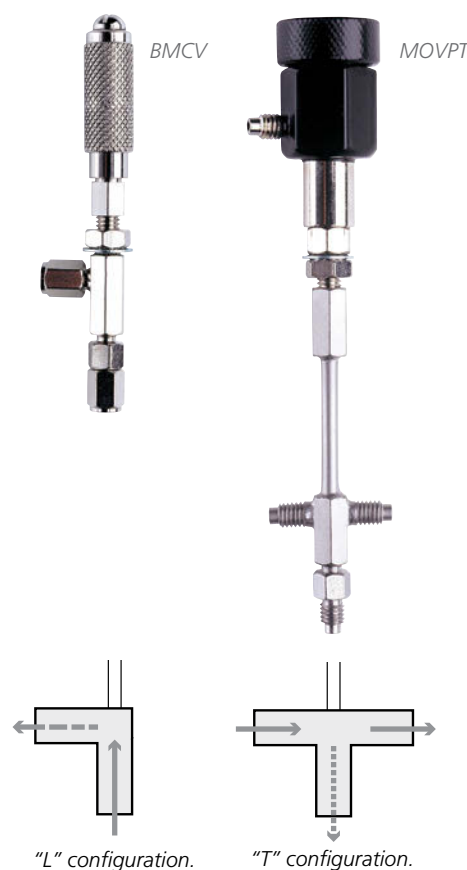

### Product Specifications

Configuration / Material	Length /Connection	Temp Rating	Vacuum Rating	Pressure Rating	Flow Rating	Valve Code
<b>Brass Micro Control Valve (BMCV) - Manual Operation</b>						
L Single Outlet, Brass	1/16 "	100 °C	No	700 psi	0-2000 mL/min	BMCV-1
<b>Stainless Steel Manual On/Off Valve (SMOV) - Manual Operation</b>						
L Single Outlet, Stainless Steel	1/16 "	100 °C	No	700 psi	n/a	SMOV
<b>On/Off valve (MOVPT) - Pneumatic Operation</b>						
L Single Outlet, Stainless Steel	50 mm, 1/16 "	300 °C	Yes	700 psi	n/a	MOVPT
T Dual Outlet, Stainless Steel	50 mm, 1/16 "	300 °C	Yes	700 psi	n/a	MOVPT
T Dual Outlet, Stainless Steel	100 mm, 1/16 "	300 °C	Yes	700 psi	n/a	MOVPT(L)

For more information about this product visit [www.sge.com](http://www.sge.com) or contact [techsupport@sge.com](mailto:techsupport@sge.com).

Vespel is a registered trademark of Dupont™.

## Accessories | Valves High Performance

Part Number	Part Description and Detail
1236282	Brass Micro Control Valve with Manual Operation (BMCV-1) - L Flow Path with Single Outlet
1236091	On/Off Valve with Pneumatic Operation (MOVPT) - L Flow Path with Single Outlet, and 50 mm Long Stem
1236103	On/Off Valve with Pneumatic Operation (MOVPT) - T Flow Path with Dual Outlet, and 50 mm Long Stem
1236104	On/Off Valve with Pneumatic Operation (MOVPT) - T Flow Path with Dual Outlet, and 100 mm Long Stem
1236283	On/Off Valve with Manual Operation (SMOV) - L Flow Path with Single Outlet
<b>Replacement Parts</b>	
072603	Replacement GFF16-16 Graphite Ferrules, PK10
072650	Replacement PSR16-16 PTFE Sealing Rings, PK20
072657	Replacement GVF16-16 Vespel Ferrules, PK10
123681	Replacement VSV-6 Vespel Valve Seat, PK5
123683	Replacement PEEK Valve Seat for SMOV Valves, PK5
123687	Replacement PTFE Seals for MOVPT Valves, PK2
123688	Replacement PTFE Seals for BMCV and MCV Valves, PK2
1236101	Seal-seat Removal Tool

For more information about this product visit [www.sge.com](http://www.sge.com) or contact [techsupport@sge.com](mailto:techsupport@sge.com).

## Product Data and Part Numbers

SGE Analytical Science (SGE) is a world renowned brand for components and consumables used in scientific analysis.

Primarily in the field of scientific glass engineering for liquid handling and separation science, since its beginnings in 1960, SGE has become the global market leader in niche areas such as autosampler syringes and GC inlet liners.

Completing the transition into Trajan after acquisition in 2013, SGE products make up a solid foundation of Trajan's portfolio and will continue to be created and supported by Trajan customer service and distribution networks worldwide.

For more information visit [www.bgb-info.com/sgc](http://www.bgb-info.com/sgc)  
or contact [sales@bgb-analytik.com](mailto:sales@bgb-analytik.com).



**Distributed By:**  
**Greyhound Chromatography and Allied Chemicals**  
**6 Kelvin Park, Birkenhead, Merseyside,**  
**CH41 1LT, UK**



**Tel: +44(0)151 649 4000 Fax: +44 (0)151 649 4001**  
**Email: [sales@greyhoundchrom.com](mailto:sales@greyhoundchrom.com) Web: [www.greyhoundchrom.com](http://www.greyhoundchrom.com)**